



# Engineering Data

MDV thermal Arctic Series Split

4~16kW



# CONTENTS

Part 1 General Information.....	3
Part 2 Engineering Data .....	19
Part 3 Installation and Field Settings.....	69



# Part 1

## General Information

1 MDV thermal Split System.....	4
2 Unit Capacities .....	6
3 Nomenclature .....	7
4 System Design and Unit Selection .....	9
5 Typical Applications .....	11



## 1 MDV thermal Split System

### 1.1 System Schematic

Figure 1-1.1: System schematic

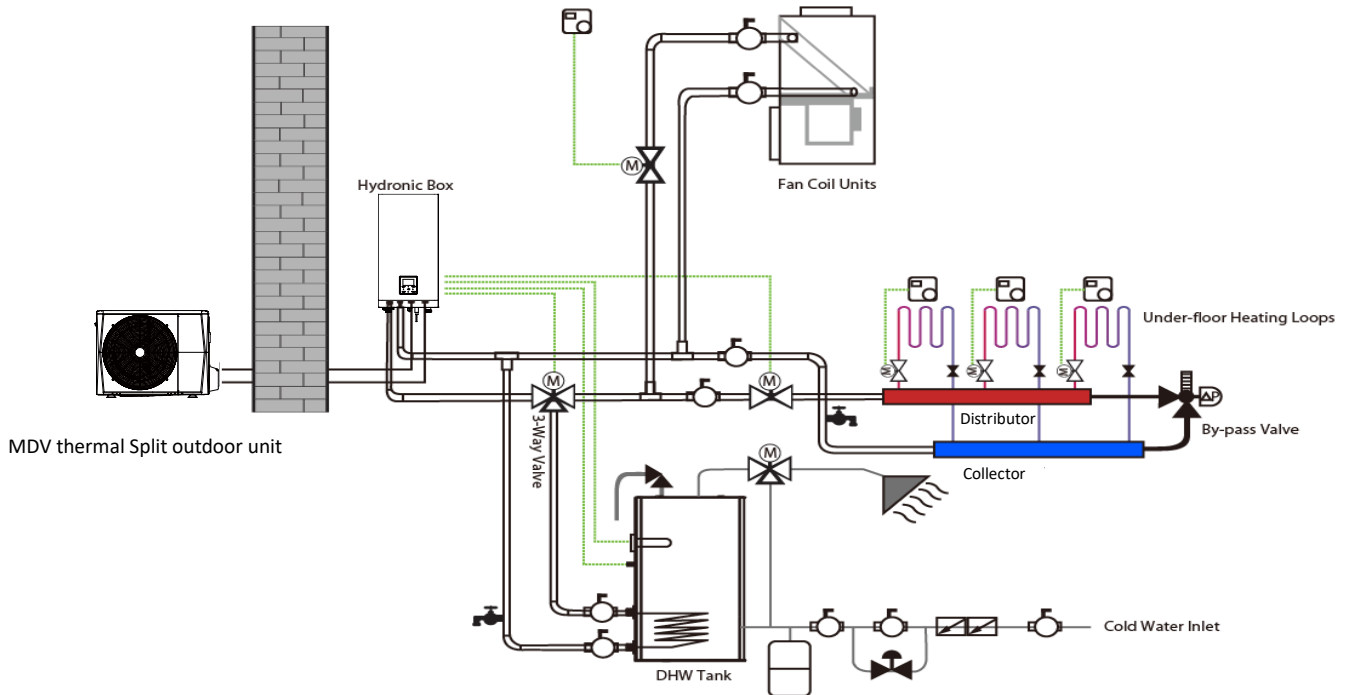

MDV thermal is an integrated air-to-water heat pump system which is one-stop solution for space heating, space cooling and domestic hot water. The outdoor heat pump system extracts heat from the outdoor air and transfers this heat through refrigerant piping to the plate heat exchanger in the hydronic box. The heated water in the hydronic box circulates to low temperature heat emitters (under-floor heating loops or low temperature radiators) to provide space heating, and to the domestic hot water tank to provide domestic hot water. The 4-way valve in the outdoor unit can reverse the refrigerant cycle so that the hydronic box can provide chilled water for cooling using fan coil units.

The heating capacity of heat pumps decreases with ambient temperature dropping. Backup electric heater is customized to provide additional heating capacity for use during extremely cold weather when the heat pump capacity is insufficient.

## 1.2 System Configurations

MDV thermal Split can be configured to run with the electric heater either enabled or disabled and can also be used in conjunction with an auxiliary heat source such as a boiler.

The chosen configuration affects the size of heat pump that is required. Three typical configurations are described below. Refer to Figure 1-1.2.

### Configuration 1: Heat pump only

- The heat pump covers the required capacity and no extra heating capacity is necessary.
- Requires selection of larger capacity heat pump and implies higher initial investment.
- Ideal for new construction in projects where energy efficiency is paramount.

### Configuration 2: Heat pump and backup electric heater

- Heat pump covers the required capacity until the ambient temperature drops below the point at which the heat pump is able to provide sufficient capacity. When the ambient temperature is below this equilibrium point (as shown in Figure 1-1.2, the backup electric heater supplies the required additional heating capacity.
- Best balance between initial investment and running costs, results in lowest lifecycle cost.
- Ideal for new construction.

### Configuration 3: Heat pump conjunction with auxiliary heat source

- Heat pump covers the required capacity until the ambient temperature drops below the point at which the heat pump is able to provide sufficient capacity. When the ambient temperature is below this equilibrium point (as shown in Figure 1-1.2, depending on the system settings, either the auxiliary heat source supplies the required additional heating capacity or the heat pump does not run and the auxiliary heat source covers the required capacity.
- Enables selection of lower capacity heat pump.
- Ideal for refurbishments and upgrades.

Figure 1-1.2: System configurations

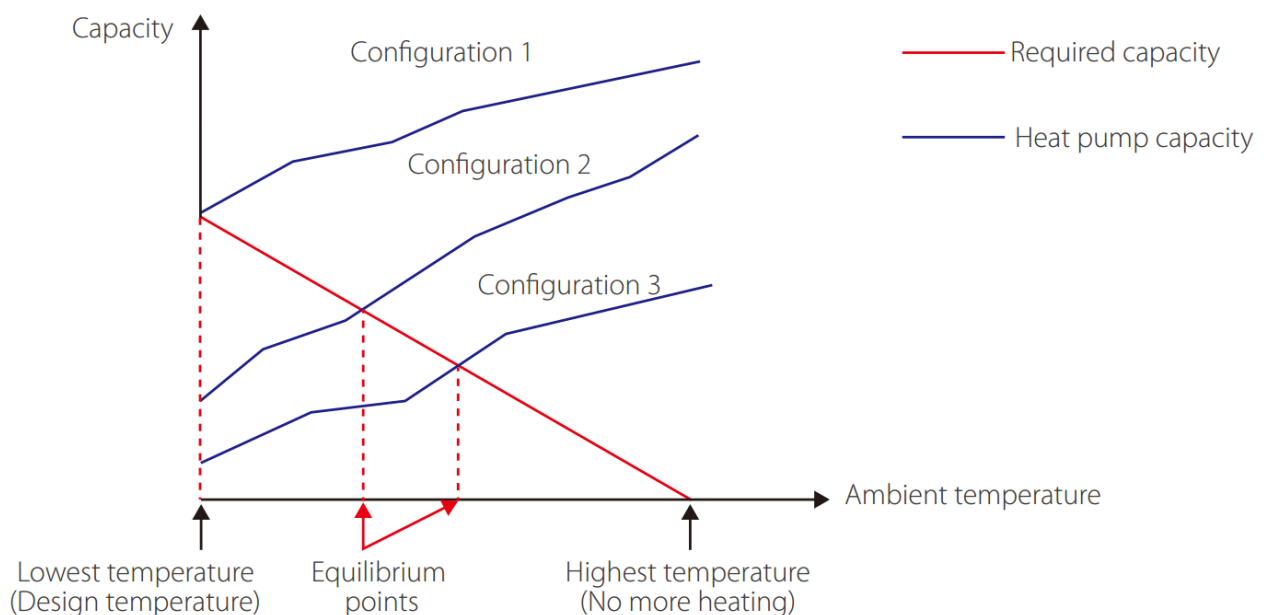

## 2 Unit Capacities

### 2.1 Outdoor unit

Table 1-2.1: Outdoor unit

Capacity	4kW	6kW
MDVA-	V4WD2ER8-A	V6WD2ER8-A
Power Supply (V/Ph/Hz)	220-240/1 /50	220-240/1 /50
Appearance		

Capacity	8kW	10kW	12kW		14kW		16kW	
Model MDVA-	V8WD2ER8-A	V10WD2ER8-A	V12WD2ER8-A	V12WD2BR8-A	V14WD2ER8-A	V14WD2BR8-A	V16WD2ER8-A	V16WD2BR8-A
Power Supply (V/Ph/Hz)	220-240/1/50	220-240/1/50	220-240/1/50	380-415/3/50	220-240/1/50	380-415/3/50	220-240/1/50	380-415/3/50
Appearance								

### 2.2 Hydronic box

Table 1-2.2: Hydronic box

Model	MDVHB-60CEGR8-A	MDVHB-100CEGR8-A	MDVHB-160CEGR8-A
Power Supply (V/Ph/Hz)	220-240/1 /50	220-240/1 /50	220-240/1 /50
Compatible outdoor unit model MDVA-	V4WD2ER8-A	V8WD2ER8-A	V12WD2ER8-A
			V14WD2ER8-A
			V16WD2ER8-A
	V6WD2ER8-A	V10WD2ER8-A	V12WD2BR8-A
V14WD2BR8-A	V16WD2BR8-A		
Appearance			

### 3 Nomenclature

#### 3.1 Outdoor unit

MDV	A	-	V	16	W	D2	E	R8	-	A	D	E	30
1	2		3	4	5	6	7	8		9	10	11	12

Legend		
No.	Code	Remarks
1	MDV	Brand: MDV brand
2	A	Type code: A: Split
3	V	Inverter
4	16	Capacity: 4: 4kW; 6: 6kW; 8: 8 kW; 10: 10 kW; 12: 12 kW; 14: 14 kW; 16: 16 kW;
5	W	Cooling type: Outdoor unit Air cooled
6	D2	Compressor and fan motor types: All DC
7	E	Power Supply of heat pump E: 1-phase, 220-240V, 50Hz B: 3-phase, 380-415V, 50Hz
8	R8	Refrigerant: R32
9	A	Version code: Arctic Series
10	D	Electric heating D: With electric heating function Omitted: Without electric heating function
11	E	Power Supply of Electric heating E: 1-phase, 220-240V, 50Hz B: 3-phase, 380-415V, 50Hz
12	90	Electric heating capacity 30: 3kW; 90: 9kW;

## 3.2 Hydronic box

MDV	HB	-	60	C	E	G	R8	-	A	D	E	30
1	2		3	4	5	6	7		8	9	10	11

Legend		
No.	Code	Remarks
1	MDV	Brand: MDV brand
2	HB	Product code HB: Hydronic box
3	60	Compatible maximum capacity of outdoor unit 60: 6kW; 100: 10 kW; 160: 16 kW
4	C	Heating type C: Water cycle with water pump
5	E	Power Supply of Hydronic box E: 1-phase, 220-240V, 50Hz
6	G	Function code G: With floor heating function
7	R8	Refrigerant: R32
8	A	Version code: Arctic Series
9	D	Electric heating D: With electric heating function Omitted: Without electric heating function
10	E	Power Supply of Electric heating E: 1-phase, 220-240V, 50Hz B: 3-phase, 380-415V, 50Hz
11	30	Electric heating capacity 30: 3kW; 90: 9kW;

## 4 System Design and Unit Selection

### 4.1 Selection procedure

#### Step 1: Total heat load calculation

Calculate conditioned surface area  
Select the heat emitters (type, quantity, water temperature and heat load)

#### Step 2: System configuration

Decide whether to include AHS and set AHS's switching temperature  
Decide whether backup electric heater is enabled or disabled

#### Step 3: Selection of outdoor units

Determine required total heat load on outdoor units  
Set capacity safety factor  
Select power supply

Provisionally select MDV thermal Split unit capacity based on nominal capacity

Correct capacity of the outdoor units for the following items:  
Outdoor air temperature / Outdoor humidity / Water outlet temperature<sup>1</sup> /  
Altitude / Anti-freeze fluid

Is corrected MDV thermal Split unit capacity  $\geq$  Required total heat load on outdoor units<sup>2</sup>

Yes

No

MDV thermal Split system selection is complete

Select a larger model or enable backup electric heater operation

#### Notes:

1. If the required water temperatures of the heat emitters are not all the same, the MDV thermal Split's outlet water temperature setting should be set at the highest of the heat emitter required water temperatures. If the water outlet design temperature falls between two temperatures listed in the outdoor unit's capacity table, calculate the corrected capacity by interpolation.
2. If the outdoor unit selection is to be based on total heating load and total cooling load, select Split units which satisfy both total heating and cooling load requirements.

## 4.2 MDV thermal Leaving Water Temperature (LWT) Selection

The recommended design LWT ranges for different types of heat emitter are:

- For floor heating: 30 to 35°C
- For fan coil units: 30 to 45°C
- For low temperature radiators: 40 to 50°C

## 4.3 Optimizing System Design

To get the most comfort with the lowest energy consumption with MDV thermal, it is important to take account of the following considerations:

- Choose heat emitters that allow the heat pump system to operate at as low a hot water temperature as possible whilst still providing sufficient heating.
- Make sure the correct weather dependency curve is selected to match the installation environment (building structure, climate) as well as ender user’s demands.
- Connecting room thermostats (field supplied) to the hydronic system helps prevent excessive space heating by stopping the outdoor unit and circulator pump when the room temperature is above the thermostat set point.

## 4.4 Tank back up heater notice

Heat pump will stop when T5(tank temperature) has reached the minimum of both T5S(tank setting temperature) and T5stop (highest tank temperature which can be reached under certain ambient temperature with heat pump only) and lasted for 5s. The value of T5stop is shown as below.

If T5S is higher than T5stop, then T5S can not be reached with heat pump only. In this case, tank back up heater is needed in order to reach T5S.

### T5stop value:

Ambient temperature(°C)	< -20	-20~15	-15~-10	-10~-5	-5~0	0~5	5~10
T5stop(°C)	35	40	45	48	52	55	56

Ambient temperature(°C)	10~15	15~20	20~25	25~30	35~40	40~65	40~65
T5stop(°C)	57	56	55	52	50	48	45

## 5 Typical Applications

### 5.1 Space Heating Only

The room thermostat is used as a switch. When there is a heating request from the room thermostat, the unit operates to achieve the target water temperature set on the user interface. When the room temperature reaches the thermostat's set temperature, the unit stops.

Figure 1-5.1: Space heating

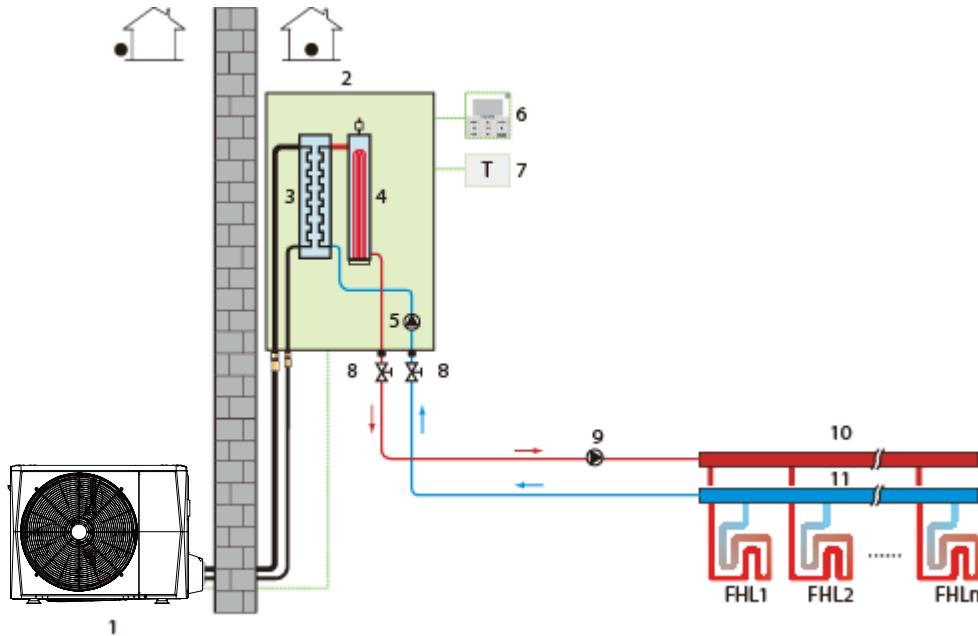

Legend			
1	Outdoor unit	7	Room thermostat (field supplied)
2	Hydronic box	8	Stop valve (field supplied)
3	Plate heat exchanger	9	External circulator pump (field supplied)
4	Backup electric heater (optional)	10	Distributor (field supplied)
5	Internal circulator pump	11	Collector (field supplied)
6	User interface	FHL 1...n	Floor heating loops (field supplied)



## 5.2 Space Heating and Domestic Hot Water

The room thermostats are not connected to the hydronic box but to a motorized valve. Each room's temperature is regulated by the motorized valve on its water circuit. Domestic hot water is supplied from the domestic hot water tank connected to the hydronic box. A bypass valve is required.

Figure 1-5.2: Space heating and domestic hot water

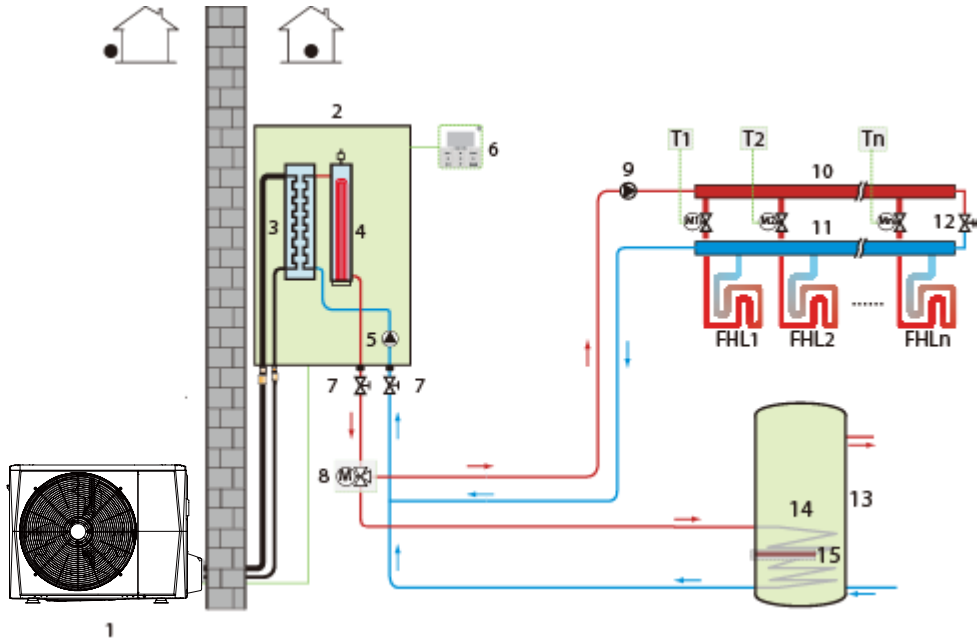

Legend			
1	Outdoor unit	10	Distributor (field supplied)
2	Hydronic box	11	Collector (field supplied)
3	Plate heat exchanger	12	Bypass valve (field supplied)
4	Backup electric heater(optional)	13	Domestic hot water tank (field supplied)
5	Internal circulator pump	14	Heat exchanger coil
6	User interface	15	Immersion heater
7	Stop valve (field supplied)	FHL 1...n	Floor heating loops (field supplied)
8	Motorized 3-way valve (field supplied)	M1...n	Motorized valves (field supplied)
9	External circulator pump (field supplied)	T1...n	Room thermostats (field supplied)

## 5.3 Space Heating, Space Cooling and Domestic Hot Water

Floor heating loops and fan coil units are used for space heating and fan coil units are used for space cooling. Domestic hot water is supplied from the domestic hot water tank connected to the hydronic box. The unit switches to heating or cooling mode according to the temperature detected by the room thermostat. In space cooling mode, the 2-way valve is closed to prevent cold water entering the floor heating loops.

Figure 1-5.3: Space heating, space cooling and domestic hot water

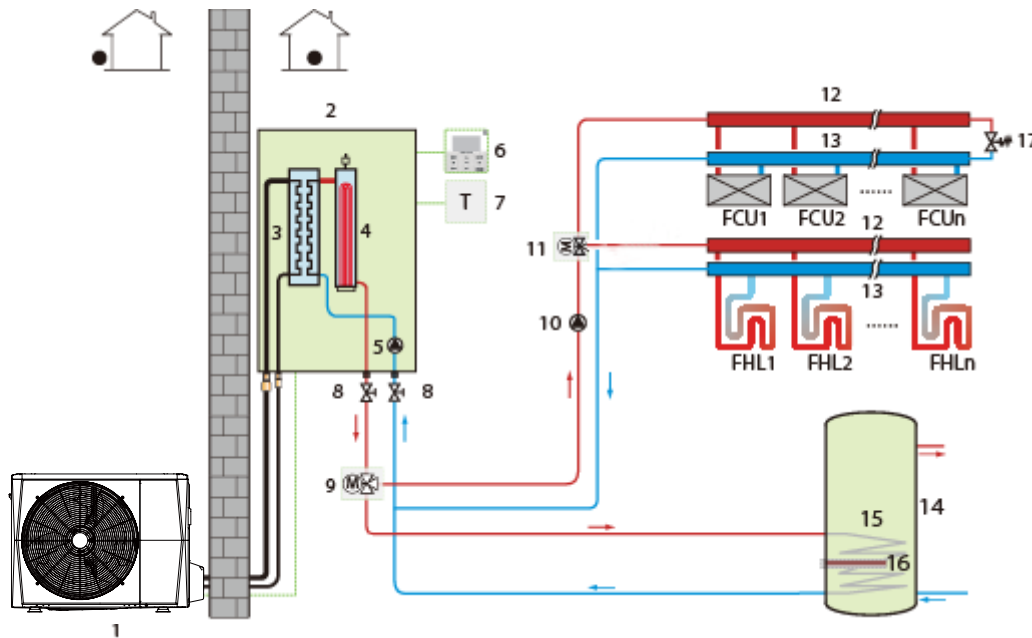

Legend			
1	Outdoor unit	11	3-way valve (field supplied)
2	Hydronic box	12	Distributor (field supplied)
3	Plate heat exchanger	13	Collector (field supplied)
4	Backup electric heater(optional)	14	Domestic hot water tank (field supplied)
5	Internal circulator pump	15	Heat exchanger coil
6	User interface	16	Immersion heater
7	Room thermostat (field supplied)	17	Bypass valve (field supplied)
8	Stop valve (field supplied)	FHL 1...n	Floor heating loops (field supplied)
9	Motorized 3-way valve (field supplied)	FCU 1...n	Fan coil units (field supplied)
10	External circulator pump (field supplied)		

# MDV thermal Arctic Split



## 5.4 Space Heating and Domestic Hot Water (Bivalent)

### 5.4.1 Auxiliary heat source provides space heating only

Figure 1-5.4: Space heating and domestic hot water with auxiliary heat source providing space heating only

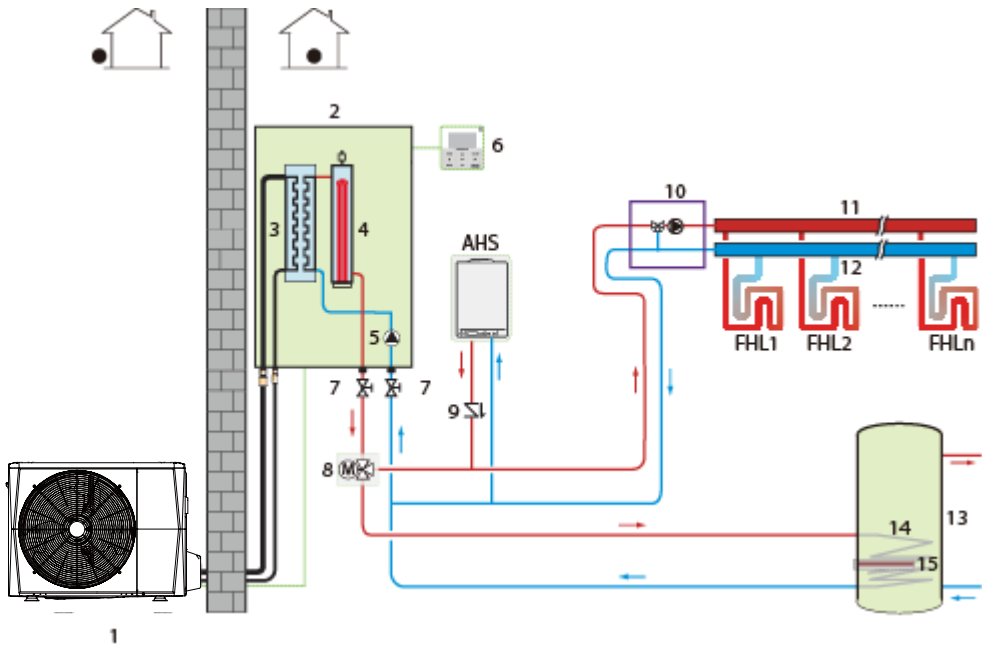

Legend			
1	Outdoor unit	10	Mixing station (field supplied)
2	Hydronic box	11	Distributor (field supplied)
3	Plate heat exchanger	12	Collector (field supplied)
4	Backup electric heater(optional)	13	Domestic hot water tank (field supplied)
5	Internal circulator pump	14	Heat exchanger coil
6	User interface	15	Immersion heater
7	Stop valve (field supplied)	FHL 1...n	Floor heating loops (field supplied)
8	Motorized 3-way valve (field supplied)	AHS	Auxiliary heating source (field supplied)
9	Non-return valve (field supplied)		

## 5.4.2 Auxiliary heat source provides space heating and domestic hot water

Figure 1-5.5: Space heating and domestic hot water with auxiliary heat source providing space heating and domestic hot water

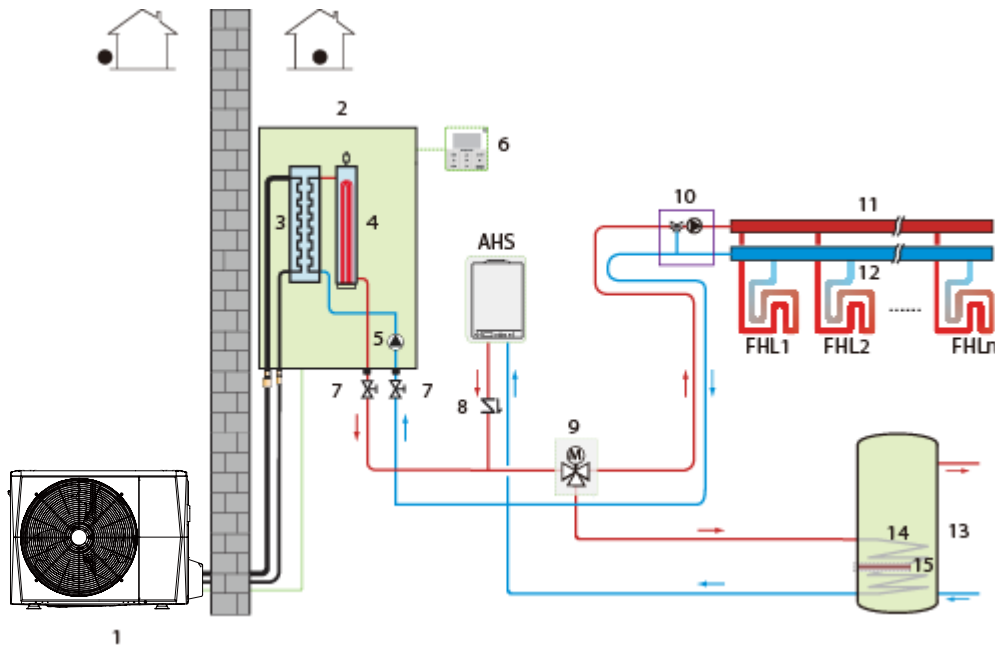

Legend			
1	Outdoor unit	10	Mixing station (field supplied)
2	Hydronic box	11	Distributor (field supplied)
3	Plate heat exchanger	12	Collector (field supplied)
4	Backup electric heater(optional)	13	Domestic hot water tank (field supplied)
5	Internal circulator pump	14	Heat exchanger coil
6	User interface	15	Immersion heater
7	Stop valve (field supplied)	FHL 1...n	Floor heating loops (field supplied)
8	Non-return valve (field supplied)	AHS	Auxiliary heating source (field supplied)
9	Motorized 3-way valve (field supplied)		

## 5.4.3 Auxiliary heat source provides additional heating

If the unit's outlet temperature is too low, the auxiliary heat source provides additional heating to raise the water temperature to the set temperature. An additional 3-way valve is required. When the unit's outlet temperature is too low, the 3-way valve is open and the water flows through the auxiliary heat source. When the unit's outlet temperature is high enough, the 3-way valve is closed.

Figure 1-5.6: Space heating and domestic hot water with auxiliary heat source providing additional heating

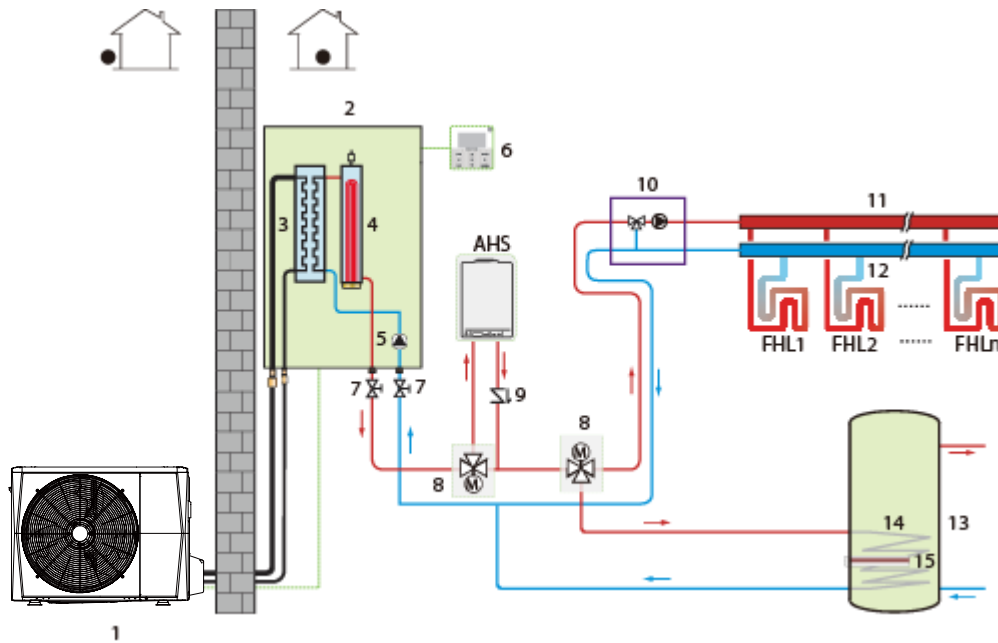

Legend			
1	Outdoor unit	10	Mixing station (field supplied)
2	Hydronic box	11	Distributor (field supplied)
3	Plate heat exchanger	12	Collector (field supplied)
4	Backup electric heater(optional)	13	Domestic hot water tank (field supplied)
5	Internal circulator pump	14	Heat exchanger coil
6	User interface	15	Immersion heater
7	Stop valve (field supplied)	FHL 1...n	Floor heating loops (field supplied)
8	Motorized 3-way valve (field supplied)	AHS	Auxiliary heating source (field supplied)
9	Non-return valve (field supplied)		

## 5.5 Space Heating Through Floor Heating Loops and Radiators

The floor heating loops and radiators require different operating water temperatures. To achieve these two set points, a mixing station is required. Room thermostats for each zone are optional. With the help of hydronic adapter board (optional), maximum 8 thermostats for 8 rooms are available to control heat pump, which greatly improves the operation convenience.

Figure 1-5.7: Space heating through floor heating loops and radiators

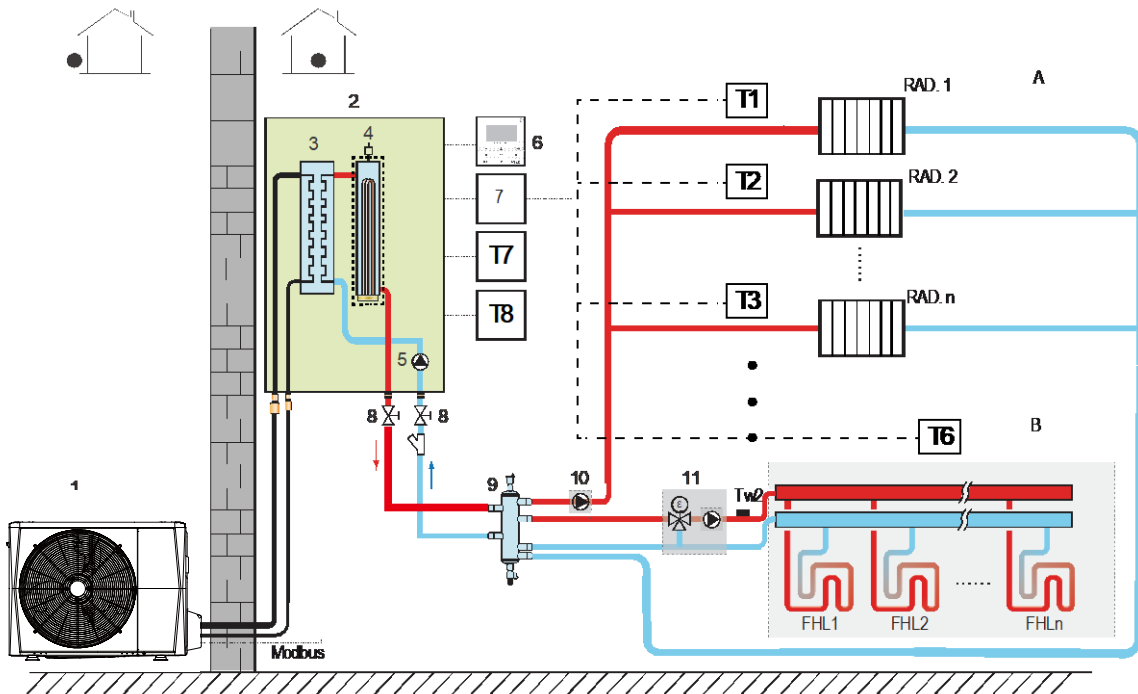

Legend			
1	Outdoor unit	10	External circulator pump (field supplied)
2	Hydronic box	11	Mixing station (field supplied)
3	Plate heat exchanger	12	Room thermostat (field supplied)
4	Backup electric heater (optional)	13	Bypass valve (field supplied)
5	Internal circulator pump	FHL 1...n	Floor heating loops (field supplied)
6	User interface (Integrated in hydronic box)	RAD 1...n	Radiators (field supplied)
7	Hydronic adapter board (Optional)	11	Mixing station (field supplied)
8	Stop valve (field supplied)	T1...8	Room thermostats (field supplied)
9	Balance tank (field supplied)		

5.6 Space Heating, Space Cooling and Domestic Hot Water Compatible with Solar Water Heater

Floor heating loops and fan coil units are used for space heating and fan coil units are used for space cooling. Domestic hot water is supplied from the domestic hot water tank connected to both the hydronic box and solar water heater. Solar water pump is controlled by Tsolar temperature sensor. Balance tank temperature sensor is used to control on/off of heat pump. Once the heat pump stops, internal pump stops to save energy and then balance tank provides hot water for space heating. In addition, balance tank temperature control can meet both space heating and domestic hot water needs at the same time.

Figure 1-5.8: Space heating, space cooling and domestic hot water compatible with solar water heater

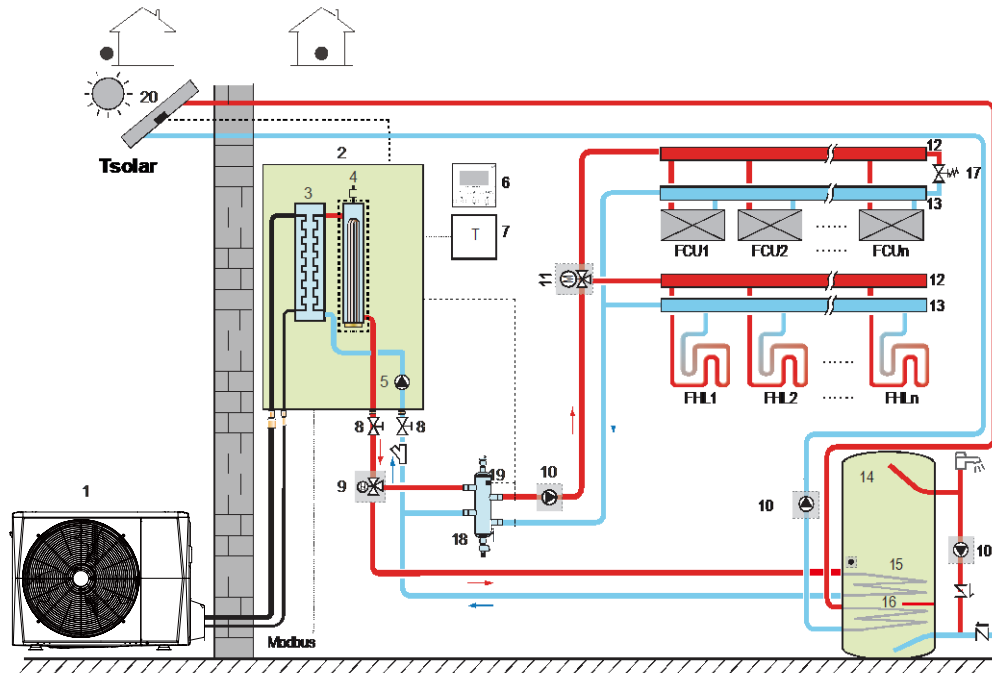

Legend			
1	Outdoor unit	12	Distributor (field supplied)
2	Hydronic box	13	Collector (field supplied)
3	Plate heat exchanger	14	Domestic hot water tank (field supplied)
4	Backup electric heater(optional)	15	Heat exchanger coil
5	Internal circulator pump	16	Immersion heater
6	User interface(Integrated in hydronic box)	17	Bypass valve (field supplied)
7	Room thermostat	18	Balance tank (field supplied)*
8	Stop valve (field supplied)	19	Balance tank temperature sensor (optional)
9	Motorized 3-way valve (field supplied)	FHL 1...n	Floor heating loops (field supplied)
10	External circulator pump (field supplied)	FCU 1...n	Fan coil units (field supplied)
11	Motorized 3-way valve (field supplied)		

Note:

- Balance tank volume requirement  
 For MDVHB-60CEGR8-A, balance tank volume  $\geq 25L$   
 For MDVHB-100CEGR8-A, balance tank volume  $\geq 25L$   
 For MDVHB-160CEGR8-A, balance tank volume  $\geq 40L$

# Part 2

## Engineering Data

<b>1 Specifications.....</b>	<b>20</b>
<b>2 Electrical Characteristics .....</b>	<b>25</b>
<b>3 Dimensions And Center Of Gravity.....</b>	<b>25</b>
<b>4 Piping Diagrams .....</b>	错误!未定义书签。
<b>5 Wiring Diagrams .....</b>	错误!未定义书签。
<b>6 Capacity Tables .....</b>	<b>27</b>
<b>7 Operating Limits .....</b>	<b>55</b>
<b>8 Hydronic Performance .....</b>	<b>56</b>
<b>9 Sound Levels.....</b>	<b>57</b>
<b>10 Accessories .....</b>	<b>62</b>



## 1 Specifications

### 1.1 Outdoor Unit

Table 2-1.1: MDVA-V4(6, 8, 10)WD2ER8-A specifications<sup>1</sup>

Model name MDVA-			V4WD2ER8-A	V6WD2ER8-A	V8WD2ER8-A	V10WD2ER8-A
Compatible hydronic box MDVHB-			60CEGR8-A		100CEGR8-A	
Power supply		V/Ph/Hz	220-240/1/50			
Heating(A7W35)	Capacity	kW	4.25	6.20	8.30	10.0
	Rated input	kW	0.82	1.24	1.60	2.00
	COP			5.20	5.00	5.20
Heating(A7W45)	Capacity	kW	4.35	6.35	8.20	10.0
	Rated input	kW	1.14	1.69	2.08	2.63
	COP			3.80	3.75	3.95
Heating(A7W55)	Capacity	kW	4.40	6.00	7.50	9.50
	Rated input	kW	1.49	2.00	2.36	3.06
	COP			2.95	3.00	3.18
Heating(A-7W35)	Capacity	kW	4.8	6.1	7.1	8.25
	Rated input	kW	1.52	2	2.18	2.62
	COP			3.15	3.05	3.25
Heating(A-7W55)	Capacity	kW	4	5.15	6.15	6.85
	Rated input	kW	2.05	2.58	3	3.43
	COP			1.95	2	2.05
Cooling(A35W18)	Capacity	kW	4.50	6.55	8.40	10.00
	Rated input	kW	0.81	1.34	1.66	2.08
	EER			5.55	4.90	5.05
Cooling(A35W7)	Capacity	kW	4.70	7.00	7.40	8.20
	Rated input	kW	1.36	2.33	2.19	2.48
	EER			3.45	3.00	3.38
Seasonal space heating energy efficiency class <sup>7</sup>	LWT at 35°C		A+++	A+++	A+++	A+++
	LWT at 55°C		A++	A++	A++	A++
SCOP <sup>7</sup>	Warmer climate	35°C	6.46	6.57	6.99	7.09
		55°C	4.15	4.21	4.51	4.62
	Average climate	35°C	A+++	A+++	A+++	A+++
			4.85	4.95	5.22	5.20
		55°C	A++	A++	A++	A++
	Colder climate	35°C	4.06	4.21	4.33	4.32
		55°C	2.63	2.85	2.88	2.99
	SEER	LWT at 7°C		4.99	5.34	5.83
LWT at 18°C		7.77	8.21	8.95	8.78	
Rated water flow		m <sup>3</sup> /h	0.73	1.07	1.43	1.72
Compressor	Type		Twin rotary DC inverter		Twin rotary DC inverter	
Outdoor fan	Motor type		Brushless DC motor		Brushless DC motor	
	Number of fans		1	1	1	1
Air side heat exchanger	Type		Finned tube		Finned tube	
Refrigerant(R32)	Factory charge	kg	1.50	1.50	1.65	1.65
Throttle type			Electronic expansion valve		Electronic expansion valve	
Piping connections	Type		Flare	Flare	Flare	Flare
	Liquid Dia.(OD)	mm	Φ6.35	Φ6.35	Φ9.52	Φ9.52
	Gas Dia.(OD)	mm	Φ15.9	Φ15.9	Φ15.9	Φ15.9
	Min. pipe length	m	2	2	2	2
	Max. pipe length	m	30	30	30	30

Installation height difference	Outdoor unit above	m	20	20	20	20
	Outdoor unit below	m	20	20	20	20
Sound power level <sup>8</sup>		dB	56	58	59	60
Sound pressure level <sup>9</sup>		dB	44	45	46	49
ODU Net dimensions (W×H×D)		mm	1008×712×426	1008×712×426	1118×865×523	1118×865×523
ODU Packed dimensions (W×H×D)		mm	1065×810×485	1065×810×485	1190×970×560	1190×970×560
ODU Net/Gross weight		kg	58/63.5	58/63.5	75/89	75/89
Operating temperature range	Cooling	°C	-5 to 43			
	Heating	°C	-25 to 35			
	DHW	°C	-25 to 43			

Note:

1. Relevant EU standards and legislation: EN14511; EN14825; EN50564; EN12102; (EU) No 811:2013; (EU) No 813:2013; OJ 2014/C 207/02:2014.
2. Test standard: EN12102-1
3. Sound pressure level is the maximum value tested under the two conditions of Heating: A7W35 and Cooling: A35W18.

Table 2-1.1: MDVA-V12(14, 16)WD2ER8-A specifications<sup>1</sup>

Model name MDVA-			V12WD2ER8-A	V14WD2ER8-A	V16WD2ER8-A
Compatible hydronic box MDVHB-			160CEGR8-A		
Power supply		V/Ph/Hz	220-240/1/50		
Heating(A7W35)	Capacity	kW	12.1	14.5	16.0
	Rated input	kW	2.44	3.09	3.56
	COP			4.95	4.70
Heating(A7W45)	Capacity	kW	12.3	14.2	16.0
	Rated input	kW	3.24	3.89	4.44
	COP			3.80	3.65
Heating(A7W55)	Capacity	kW	12.0	13.8	16.0
	Rated input	kW	3.87	4.60	5.52
	COP			3.10	3.00
Heating(A-7W35)	Capacity	kW	10	12	13.3
	Rated input	kW	3.33	4.29	4.93
	COP			3	2.8
Heating(A-7W55)	Capacity	kW	10	11	12.5
	Rated input	kW	4.88	5.37	6.19
	COP			2.05	2.05
Cooling(A35W18)	Capacity	kW	12.00	13.50	14.2
	Rated input	kW	3.00	3.74	3.94
	EER			4.00	3.61
Cooling(A35W7)	Capacity	kW	11.6	12.7	14.0
	Rated input	kW	4.22	4.98	5.71
	EER			2.75	2.55
Seasonal space heating energy efficiency class <sup>7</sup>	LWT at 35°C		A+++	A+++	A+++
	LWT at 55°C		A++	A++	A++
SCOP <sup>7</sup>	Warmer climate	35°C	6.48	6.58	6.29
		55°C	4.43	4.49	4.48
	Average climate	35°C	A+++	A+++	A+++
			4.81	4.72	4.62
	Colder climate	55°C	A++	A++	A++
			3.45	3.47	3.41
	35°C	4.08	4.07	4.02	
	55°C	3.02	3.05	3.12	

# MDV thermal Arctic Split



SEER	LWT at 7°C		4.89	4.86	4.69
	LWT at 18°C		7.1	6.9	6.75
Rated water flow		m <sup>3</sup> /h	2.08	2.49	2.75
Compressor	Type		Twin rotary DC inverter		
Outdoor fan	Motor type		Brushless DC motor		
	Number of fans		1	1	1
Air side heat exchanger	Type		Finned tube		
Refrigerant(R32)	Factory charge	kg	1.84	1.84	1.84
Throttle type			Electronic expansion valve		
Piping connections	Type		Flare	Flare	Flare
	Liquid Dia.(OD)	mm	Φ9.52	Φ9.52	Φ9.52
	Gas Dia.(OD)	mm	Φ15.9	Φ15.9	Φ15.9
	Min. / Max. pipe length	m	2/30	2/30	2/30
Installation height difference	Outdoor unit above	m	20	20	20
	Outdoor unit below	m	20	20	20
Sound power level <sup>8</sup>		dB	64	65	68
Sound pressure level <sup>9</sup>		dB	50	51	54
ODU Net dimensions (W×H×D)		mm	1118×865×523	1118×865×523	1118×865×523
ODU Packed dimensions (W×H×D)		mm	1190×970×560	1190×970×560	1190×970×560
ODU Net/Gross weight		kg	97/110.5	97/110.5	97/110.5
Operating temperature range	Cooling	°C	-5 to 43		
	Heating	°C	-25 to 35		
	DHW	°C	-25 to 43		

Note:

1. Relevant EU standards and legislation: EN14511; EN14825; EN50564; EN12102; (EU) No 811:2013; (EU) No 813:2013; OJ 2014/C 207/02:2014.
2. Test standard: EN12102-1
3. Sound pressure level is the maximum value tested under the two conditions of Heating: A7W35 and Cooling: A35W18.

Table 2-1.1: MDVA-V12(14, 16)WD2BR8-A specifications<sup>1</sup>

Model name MDVA-			V12WD2BR8-A	V14WD2BR8-A	V16WD2BR8-A
Compatible hydronic box MDVHB-			160CEGR8-A		
Power supply		V/Ph/H	380-415/3/50		
Heating(A7W35)	Capacity	kW	12.1	14.5	16.0
	Rated input	kW	2.44	3.09	3.56
	COP			4.95	4.70
Heating(A7W45)	Capacity	kW	12.3	14.2	16.0
	Rated input	kW	3.24	3.89	4.44
	COP			3.80	3.65
Heating(A7W55)	Capacity	kW	12.0	13.8	16.0
	Rated input	kW	3.87	4.60	5.52
	COP			3.10	3.00
Heating(A-7W35)	Capacity	kW	10	12	13.3
	Rated input	kW	3.33	4.29	4.93
	COP			3	2.8
Heating(A-7W55)	Capacity	kW	10	11	12.5
	Rated input	kW	4.88	5.37	6.19
	COP			2.05	2.05
Cooling(A35W18)	Capacity	kW	12.00	13.50	14.2
	Rated input	kW	3.00	3.74	3.94
	EER			4.00	3.61

Cooling(A35W7)	Capacity	kW	11.6	12.7	14.0
	Rated input	kW	4.22	4.98	5.71
	EER		2.75	2.55	2.45
Seasonal space heating energy efficiency class	LWT at 35°C		A+++	A+++	A+++
	LWT at 55°C		A++	A++	A++
SCOP	Warmer climate	35°C	6.47	6.57	6.28
		55°C	4.42	4.49	4.47
	Average climate	35°C	A+++	A+++	A+++
			4.81	4.72	4.62
	Colder climate	55°C	A++	A++	A++
			3.45	3.47	3.41
SEER	LWT at 7°C		4.86	4.83	4.67
	LWT at 18°C		7.04	6.85	6.71
Rated water flow		m <sup>3</sup> /h	2.08	2.49	2.75
Compressor	Type		Twin rotary DC inverter		
Outdoor fan	Motor type		Brushless DC motor		
	Number of fans		1	1	1
Air side heat exchanger	Type		Finned tube		
Refrigerant(R32)	Factory charge	kg	1.84	1.84	1.84
Throttle type			Electronic expansion valve		
Piping connections	Type		Flare	Flare	Flare
	Liquid/ Gas Dia.(OD)	mm	Φ9.52/15.9	Φ9.52/15.9	Φ9.52/15.9
	Min. /Max. pipe length	m	2/30	2/30	2/30
Installation height difference	Outdoor unit above/below	m	20	20	20
Sound power level <sup>2</sup>		dB	64	65	68
Sound pressure level(1m) <sup>3</sup>		dB	50	51	55
ODU Net dimensions (W×H×D)		mm	1118×865×523	1118×865×523	1118×865×523
ODU Packed dimensions (W×H×D)		mm	1190×970×560	1190×970×560	1190×970×560
ODU Net/Gross weight		kg	112/125.5	112/125.5	112/125.5
Operating temperature range	Cooling	°C	-5 to 43		
	Heating	°C	-25 to 35		
	DHW	°C	-25 to 43		

**Note:**

1. Relevant EU standards and legislation: EN14511; EN14825; EN50564; EN12102; (EU) No 811:2013; (EU) No 813:2013; OJ 2014/C 207/02:2014.
2. Test standard: EN12102-1
3. Sound pressure level is the maximum value tested under the two conditions of Heating: A7W35 and Cooling: A35W18.

## 1.2 Hydronic Box

Table 2-1.2: MDVHB-A60(100,160)CEGR8-A specifications

Model name MDVHB-			60CEGR8-A	100CEGR8-A	160CEGR8-A	
Compatible Outdoor unit model MDVA-			V4(6)WD2ER8-A	V8(10)WD2ER8-A	V12(14,16)W/D2(R)N8-B	
Function			Heating and cooling			
Setting water temperature range	Cooling	°C	5~25			
	Heating	°C	25~65			
	DHW <sup>3</sup>	°C	20~60			
Power supply		V/Ph/Hz	220-240/1/50	220-240/1/50	220-240/1/50	
Sound power level <sup>1</sup>		dB	38	42	43	
Sound pressure level(1m) <sup>2</sup>		dB	28	30	32	
Dimension (W×H×D)		mm	420×790×270	420×790×270	420×790×270	
Packing (W×H×D)		mm	525×1050×360	525×1050×360	525×1050×360	
Net/gross weight		kg	37/43	37/43	39/45	
Water circuit	Piping connections		inch	R1"	R1"	R1"
	Safety valve set pressure		MPa	0.3	0.3	0.3
	Drainage pipe connection		mm	Φ25	Φ25	Φ25
	Expansion tank	Volume	L	8.0	8.0	8.0
		Max. water pressure	MPa	0.3	0.3	0.3
		Pre-pressure	MPa	0.1	0.1	0.1
	Water side	Type		Plate type	Plate type	Plate type
	Water pump head		m	9	9	9
	Water flow range		m <sup>3</sup> /h	0.4~1.25	0.4~2.10	0.70~3.00
Internal water volume		L	2.2-5.0	2.2-5.0	2.5-7.3	
Refrigerant circuit	Liquid Dia. (OD)		mm	Φ6.35	Φ9.52	Φ9.52
	Gas Dia. (OD)		mm	Φ15.9	Φ15.9	Φ15.9

Note: 1. Test standard: EN12102-1

2. Sound pressure level is the maximum value tested under the two conditions of Heating: A7W35 and Cooling: A35W18 for different combination between outdoor unit and hydronic box.

3. Maximum domestic hot water temperature 60°C is only available with TBH support.

## 2 Electrical characteristics

System	Outdoor unit				Power current			Compressor		Fan	
	Voltage (V)	Hz	Min. (V)	Max. (V)	MCA (A)	TOCA (A)	MFA (A)	MSC (A)	RLA (A)	kW	FLA (A)
MDVA-V4WD2ER8-A	220~240	50	198	264	12	18	25	-	11.5	0.10	0.5
MDVA-V6WD2ER8-A	220~240	50	198	264	14	18	25	-	13.5	0.10	0.5
MDVA-V8WD2ER8-A	220~240	50	198	264	16	19	25	-	14.5	0.17	1.5
MDVA-V10WD2ER8-A	220~240	50	198	264	17	19	25	-	15.5	0.17	1.5
MDVA-V12WD2ER8-A	220~240	50	198	264	25	30	35	-	23.5	0.17	1.5
MDVA-V14WD2ER8-A	220~240	50	198	264	26	30	35	-	24.5	0.17	1.5
MDVA-V16WD2ER8-A	220~240	50	198	264	27	30	35	-	25.5	0.17	1.5
MDVA-V12WD2BR8-A	380~415	50	342	456	10	14	16	-	9.15	0.17	1.5
MDVA-V14WD2BR8-A	380~415	50	342	456	11	14	16	-	10.15	0.17	1.5
MDVA-V16WD2BR8-A	380~415	50	342	456	12	14	16	-	11.15	0.17	1.5

Note:

MCA: Min. Circuit Amps. (A)

TOCA: Total Over-current Amps. (A)

MFA: Max. Fuse Amps. (A)

MSC: Max. Starting Amps. (A)

RLA: Rated Load Amps. (A)

The input Amps of compressor where MAX. Hz can operate for nominal cooling or heating test condition

kW: Rated Motor Output

FLA: Full Load Amps. (A)

## 3 Dimensions and Center of Gravity

### 3.1 Outdoor Unit

#### MDVA-V4(6)WD2ER8-A

Figure 2-3.1: Dimensions and center of gravity (unit: mm)

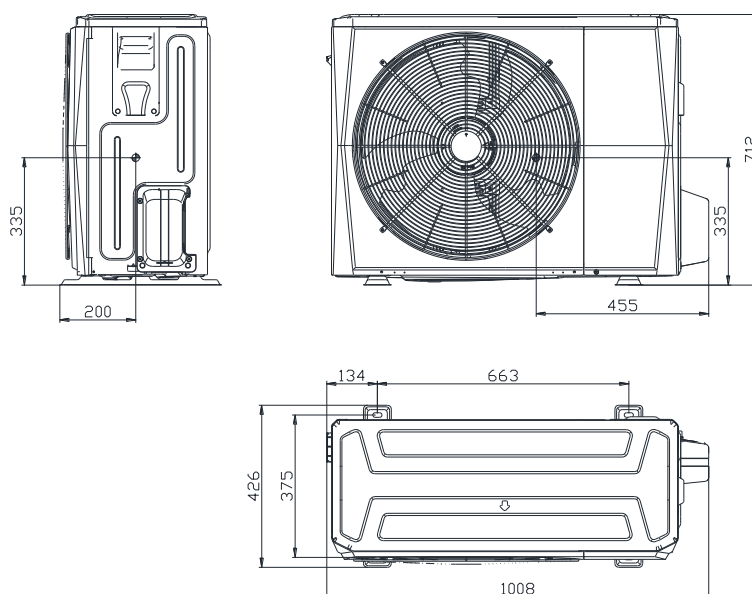

# MDV thermal Arctic Split



MDVA-V8(10,12,14,16)WD2ER8-A

MDVA-V12(14,16)WD2BR8-A

Figure 2-3.2: Dimensions and center of gravity (unit: mm)

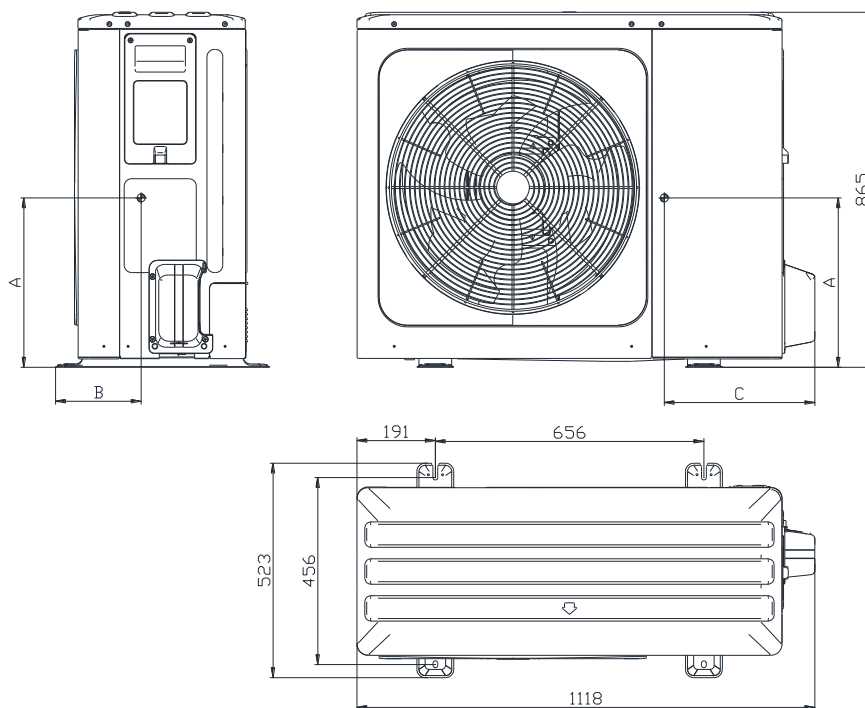

Model	A	B	C
MDVA-V8WD2ER8-A MDVA-V10WD2ER8-A	350	220	560
MDVA-V12WD2ER8-A MDVA-V14WD2ER8-A MDVA-V16WD2ER8-A	355	275	520
MDVA-V12WD2BR8-A MDVA-V14WD2BR8-A MDVA-V16WD2BR8-A	465	250	445

## 3.2 Hydronic Box

Figure 2-3.3: Dimensions and center of gravity (unit: mm)

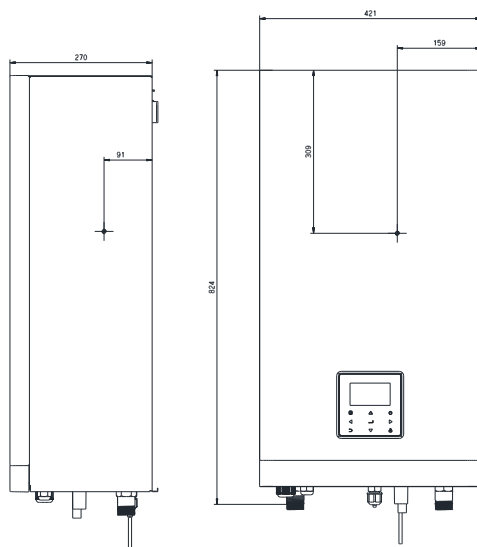

## 4 Capacity Tables

### 4.1 Heating Capacity Tables (Test standard: EN14511)

Table 2-4.1-1: Heating capacity for 4kW models

Maximum															
DB	LWT														
	25			30			35			40			45		
	HC	PI	COP	HC	PI	COP	HC	PI	COP	HC	PI	COP	HC	PI	COP
-25	2.05	1.18	1.74	1.80	1.22	1.48	1.71	1.32	1.29	1.53	1.30	1.18	1.37	1.25	1.10
-20	3.09	1.31	2.36	2.83	1.56	1.82	2.44	1.70	1.43	2.17	1.74	1.24	1.98	1.75	1.13
-15	3.60	1.19	3.03	3.41	1.22	2.78	3.25	1.36	2.39	2.93	1.49	1.97	2.50	1.60	1.56
-10	4.47	1.33	3.36	4.29	1.33	3.23	4.14	1.45	2.85	4.02	1.65	2.43	3.59	1.77	2.02
-7	5.11	1.39	3.67	5.03	1.43	3.51	4.99	1.65	3.01	4.67	1.73	2.70	4.54	1.98	2.29
-5	5.18	1.29	4.03	5.08	1.36	3.72	5.02	1.53	3.27	4.74	1.68	2.82	4.63	1.89	2.45
-2	5.14	1.18	4.36	5.01	1.25	3.99	4.91	1.41	3.47	4.70	1.58	2.97	4.77	1.80	2.65
0	5.41	1.07	5.06	5.27	1.21	4.34	5.10	1.36	3.74	4.92	1.55	3.18	5.04	1.74	2.89
2	5.63	1.07	5.28	5.44	1.21	4.51	5.28	1.36	3.87	5.18	1.55	3.35	5.25	1.77	2.97
5	5.99	1.07	5.58	5.75	1.18	4.85	5.68	1.31	4.33	5.59	1.48	3.77	5.60	1.71	3.27
7	6.38	1.03	6.17	6.22	1.15	5.40	6.26	1.26	4.96	6.26	1.42	4.41	5.96	1.63	3.67
10	6.37	0.99	6.43	6.03	1.07	5.66	6.07	1.16	5.22	5.91	1.28	4.63	6.05	1.55	3.90
12	6.22	0.95	6.59	5.90	1.01	5.83	5.93	1.10	5.42	5.98	1.23	4.85	6.15	1.51	4.06
14	6.12	0.92	6.66	5.80	0.98	5.92	5.84	1.06	5.51	5.99	1.21	4.95	6.17	1.49	4.14
15	6.03	0.90	6.71	5.72	0.96	5.98	5.75	1.03	5.59	6.00	1.19	5.04	6.20	1.47	4.21
19	5.90	0.83	7.14	5.74	0.87	6.60	5.77	0.99	5.83	6.06	1.12	5.39	6.14	1.34	4.57
20	5.86	0.81	7.24	5.74	0.85	6.75	5.77	0.98	5.88	6.08	1.11	5.48	6.12	1.31	4.66
25	5.70	0.72	7.91	5.77	0.80	7.21	5.81	0.94	6.15	5.91	0.98	6.06	6.05	1.15	5.25
30	5.78	0.69	8.41	5.84	0.78	7.48	5.78	0.86	6.71	5.89	0.92	6.39	6.02	1.07	5.62
35	5.85	0.65	8.96	5.90	0.76	7.77	5.97	0.82	7.27	5.86	0.87	6.77	5.99	0.99	6.05
40	6.30	0.58	10.84	6.38	0.67	9.51	6.36	0.74	8.57	6.33	0.80	7.88	6.38	0.93	6.86
43	6.57	0.54	12.20	6.67	0.62	10.80	6.59	0.69	9.50	6.62	0.77	8.63	6.61	0.89	7.39

DB	LWT														
	50			55			58			60			65		
	HC	PI	COP	HC	PI	COP	HC	PI	COP	HC	PI	COP	HC	PI	COP
-25	/	/	/	/	/	/	/	/	/	/	/	/	/	/	/
-20	1.85	1.75	1.06	1.56	1.59	0.98	1.38	1.49	0.93	/	/	/	/	/	/
-15	2.20	1.68	1.31	1.84	1.56	1.18	1.77	1.62	1.09	1.73	1.68	1.03	/	/	/
-10	3.28	1.81	1.81	2.63	1.68	1.56	2.74	1.76	1.56	2.81	1.80	1.56	/	/	/
-7	4.41	2.12	2.08	4.28	2.34	1.83	3.85	2.10	1.83	3.56	1.94	1.84	/	/	/
-5	4.56	2.02	2.26	4.41	2.26	1.95	4.06	2.10	1.93	3.83	2.00	1.92	/	/	/
-2	4.74	2.01	2.36	4.72	2.20	2.15	4.35	2.11	2.06	4.10	2.06	1.99	/	/	/
0	5.02	2.03	2.48	5.13	2.16	2.37	4.69	2.13	2.20	4.40	2.10	2.09	/	/	/
2	5.19	2.06	2.52	5.26	2.17	2.42	4.86	2.16	2.25	4.59	2.16	2.13	/	/	/
5	5.50	1.98	2.78	5.54	2.07	2.68	5.16	2.08	2.48	4.90	2.09	2.35	4.04	2.16	1.87
7	5.69	1.83	3.11	5.74	2.03	2.83	5.54	2.06	2.70	5.41	2.08	2.61	4.27	2.09	2.04
10	5.80	1.71	3.40	5.70	1.80	3.16	5.44	1.89	2.88	5.27	1.96	2.69	4.49	2.02	2.22
12	5.76	1.63	3.53	5.69	1.73	3.29	5.38	1.80	2.99	5.17	1.86	2.79	4.70	1.96	2.40
14	5.71	1.59	3.60	5.65	1.69	3.35	5.32	1.75	3.04	5.10	1.80	2.83	4.79	1.93	2.48
15	5.67	1.55	3.65	5.63	1.65	3.41	5.27	1.71	3.08	5.04	1.76	2.87	4.87	1.90	2.56
19	5.71	1.46	3.92	5.54	1.53	3.63	5.11	1.57	3.26	4.82	1.60	3.02	5.22	1.82	2.87
20	5.72	1.43	3.99	5.52	1.50	3.68	5.07	1.53	3.31	4.77	1.56	3.06	/	/	/
25	5.68	1.29	4.39	5.42	1.35	4.02	4.86	1.35	3.59	4.50	1.36	3.30	/	/	/
30	5.67	1.22	4.63	5.51	1.28	4.31	4.97	1.30	3.83	4.61	1.32	3.51	/	/	/
35	5.59	1.14	4.90	5.61	1.22	4.62	/	/	/	/	/	/	/	/	/
40	6.00	1.15	5.20	/	/	/	/	/	/	/	/	/	/	/	/
43	6.25	1.16	5.38	/	/	/	/	/	/	/	/	/	/	/	/

Abbreviations:

LWT: Leaving water temperature (°C)

DB: Dry-bulb temperature for Outdoor air temperature (°C)

HC: Total heating capacity (kW)

PI: Power input (kW)



Table 2-4.1-2: Heating capacity for 4kW models

Normal															
DB	LWT														
	25			30			35			40			45		
	HC	PI	COP	HC	PI	COP	HC	PI	COP	HC	PI	COP	HC	PI	COP
-25	1.90	1.07	1.78	1.65	1.08	1.52	1.56	1.19	1.31	1.42	1.20	1.19	1.28	1.18	1.09
-20	2.82	1.15	2.45	2.57	1.38	1.86	2.20	1.49	1.48	1.98	1.57	1.26	1.83	1.61	1.14
-15	3.26	1.03	3.17	3.07	1.06	2.88	2.90	1.17	2.48	2.66	1.31	2.02	2.22	1.40	1.59
-10	4.00	1.11	3.60	3.92	1.15	3.40	3.82	1.30	2.95	3.60	1.45	2.49	3.25	1.59	2.05
-7	4.68	1.21	3.85	4.61	1.26	3.65	4.70	1.52	3.10	4.26	1.52	2.81	4.30	1.83	2.35
-5	4.69	1.11	4.22	4.62	1.19	3.86	4.37	1.28	3.41	4.21	1.42	2.96	4.20	1.65	2.54
-2	4.70	1.04	4.52	4.56	1.11	4.12	4.26	1.19	3.59	4.26	1.39	3.06	4.27	1.56	2.74
0	4.99	0.96	5.19	4.80	1.08	4.46	4.40	1.15	3.85	4.53	1.40	3.23	4.46	1.49	3.00
2	5.18	0.95	5.45	4.94	1.05	4.70	4.40	1.10	4.00	4.77	1.39	3.44	5.10	1.70	3.00
5	5.48	0.95	5.79	5.19	1.03	5.03	5.08	1.13	4.49	5.11	1.32	3.86	4.82	1.41	3.42
7	4.60	0.71	6.48	4.36	0.77	5.65	4.20	0.82	5.10	4.38	0.95	4.64	4.30	1.13	3.80
10	5.73	0.83	6.88	5.28	0.89	5.91	5.36	1.00	5.37	5.24	1.09	4.83	5.48	1.35	4.05
12	5.62	0.79	7.11	5.19	0.85	6.13	5.26	0.94	5.61	5.28	1.03	5.11	5.60	1.33	4.22
14	5.54	0.76	7.25	5.11	0.82	6.26	5.19	0.90	5.76	5.27	1.00	5.27	5.62	1.30	4.31
15	5.48	0.75	7.32	5.06	0.80	6.33	5.14	0.88	5.84	5.28	0.98	5.38	5.67	1.30	4.37
19	5.38	0.69	7.83	5.10	0.72	7.04	5.10	0.83	6.13	5.53	0.96	5.79	5.64	1.18	4.77
20	5.36	0.67	7.96	5.11	0.71	7.22	5.09	0.82	6.21	5.59	0.95	5.89	5.63	1.16	4.88
25	5.08	0.58	8.75	5.24	0.67	7.85	5.12	0.78	6.57	5.47	0.83	6.55	5.67	1.02	5.53
30	5.18	0.55	9.37	5.33	0.65	8.20	5.32	0.74	7.21	5.48	0.79	6.97	5.67	0.95	5.97
35	5.29	0.53	10.05	5.44	0.63	8.57	5.54	0.70	7.89	5.50	0.74	7.43	5.70	0.88	6.47
40	5.78	0.47	12.23	5.77	0.55	10.57	5.73	0.61	9.37	5.78	0.66	8.70	5.89	0.80	7.38
43	6.08	0.44	13.87	6.09	0.50	12.08	6.00	0.57	10.46	6.09	0.63	9.60	6.15	0.77	8.01
DB	LWT														
	50			55			58			60			65		
	HC	PI	COP	HC	PI	COP	HC	PI	COP	HC	PI	COP	HC	PI	COP
-25	/	/	/	/	/	/	/	/	/	/	/	/	/	/	/
-20	1.73	1.61	1.07	1.50	1.52	0.99	1.37	1.46	0.93	/	/	/	/	/	/
-15	1.96	1.46	1.34	1.69	1.41	1.20	1.64	1.49	1.10	1.61	1.56	1.03	/	/	/
-10	2.99	1.62	1.84	2.40	1.52	1.58	2.51	1.61	1.56	2.59	1.67	1.55	/	/	/
-7	4.12	1.93	2.14	4.00	2.05	1.95	3.49	1.84	1.89	3.15	1.68	1.87	/	/	/
-5	4.14	1.78	2.32	4.04	2.02	2.00	3.67	1.86	1.97	3.42	1.75	1.95	/	/	/
-2	4.22	1.75	2.41	4.19	1.87	2.23	3.84	1.83	2.10	3.63	1.81	2.01	/	/	/
0	4.41	1.75	2.52	4.43	1.78	2.49	4.09	1.82	2.25	3.87	1.86	2.09	/	/	/
2	5.03	1.96	2.56	5.10	2.08	2.45	4.46	1.96	2.28	4.04	1.87	2.16	/	/	/
5	4.53	1.59	2.86	4.56	1.66	2.75	4.39	1.74	2.52	4.28	1.81	2.37	3.30	1.68	1.96
7	4.54	1.37	3.32	4.40	1.49	2.95	4.32	1.56	2.77	4.27	1.61	2.65	3.54	1.64	2.16
10	5.20	1.51	3.45	4.96	1.54	3.23	4.89	1.66	2.94	4.84	1.76	2.74	3.67	1.56	2.35
12	5.17	1.42	3.65	4.98	1.47	3.38	4.86	1.58	3.07	4.78	1.67	2.86	3.86	1.50	2.57
14	5.13	1.36	3.76	4.96	1.43	3.47	4.81	1.53	3.15	4.72	1.61	2.93	3.93	1.46	2.69
15	5.11	1.33	3.83	4.96	1.40	3.53	4.79	1.50	3.19	4.68	1.58	2.97	4.03	1.45	2.77
19	5.24	1.26	4.15	4.90	1.30	3.78	4.66	1.39	3.34	4.50	1.48	3.05	4.39	1.40	3.13
20	5.27	1.25	4.23	4.89	1.27	3.84	4.63	1.37	3.38	4.45	1.45	3.07	/	/	/
25	5.30	1.13	4.68	4.89	1.16	4.23	4.52	1.22	3.70	4.28	1.28	3.34	/	/	/
30	5.45	1.10	4.97	5.01	1.10	4.56	4.65	1.17	3.97	4.41	1.23	3.57	/	/	/
35	5.42	1.02	5.30	5.14	1.04	4.92	/	/	/	/	/	/	/	/	/
40	5.66	1.00	5.67	/	/	/	/	/	/	/	/	/	/	/	/
43	5.94	1.01	5.90	/	/	/	/	/	/	/	/	/	/	/	/

Abbreviations:

LWT: Leaving water temperature (°C)

DB: Dry-bulb temperature for Outdoor air temperature (°C)

HC: Total heating capacity (kW)

PI: Power input (kW)

Table 2-4.1-3: Heating capacity for 4kW models

Minimum															
DB	LWT														
	25			30			35			40			45		
	HC	PI	COP	HC	PI	COP	HC	PI	COP	HC	PI	COP	HC	PI	COP
-25	1.23	0.68	1.80	1.12	0.72	1.55	1.18	0.89	1.33	1.09	0.90	1.20	0.86	0.79	1.10
-20	1.73	0.69	2.50	1.53	0.80	1.90	1.42	0.94	1.51	1.39	1.08	1.29	1.23	1.07	1.15
-15	1.68	0.52	3.25	1.65	0.56	2.95	1.55	0.61	2.54	1.64	0.79	2.07	1.60	1.00	1.61
-10	1.65	0.45	3.70	1.75	0.50	3.50	1.71	0.56	3.04	2.09	0.82	2.56	2.17	1.04	2.09
-7	1.16	0.29	4.01	1.18	0.31	3.76	1.25	0.37	3.34	2.06	0.70	2.93	2.08	0.86	2.42
-5	1.36	0.31	4.38	1.36	0.34	3.98	1.42	0.40	3.51	2.06	0.67	3.07	2.16	0.83	2.60
-2	1.36	0.29	4.68	1.39	0.33	4.25	1.38	0.37	3.70	2.03	0.64	3.17	2.16	0.77	2.80
0	1.45	0.27	5.37	1.51	0.33	4.61	1.42	0.36	3.98	2.12	0.63	3.34	2.22	0.72	3.07
2	1.69	0.30	5.71	1.73	0.36	4.87	1.65	0.39	4.23	2.33	0.65	3.60	2.39	0.74	3.23
5	1.97	0.33	6.03	1.99	0.38	5.23	1.92	0.41	4.66	2.58	0.64	4.01	2.59	0.74	3.52
7	2.35	0.35	6.78	2.34	0.40	5.89	2.31	0.43	5.39	2.95	0.62	4.78	3.22	0.82	3.91
10	1.95	0.27	7.21	1.77	0.29	6.17	1.92	0.34	5.61	2.84	0.56	5.06	3.27	0.78	4.21
12	2.17	0.29	7.48	2.02	0.32	6.40	2.10	0.36	5.87	2.92	0.54	5.38	3.37	0.77	4.40
14	2.26	0.30	7.66	2.13	0.32	6.56	2.17	0.36	6.04	2.93	0.53	5.57	3.39	0.75	4.52
15	2.36	0.31	7.72	2.25	0.34	6.62	2.25	0.37	6.12	2.96	0.52	5.68	3.43	0.75	4.58
19	2.58	0.31	8.27	2.70	0.37	7.38	2.86	0.44	6.44	3.70	0.60	6.12	3.72	0.74	5.01
20	2.64	0.31	8.41	2.81	0.37	7.58	3.01	0.46	6.53	3.88	0.62	6.23	3.80	0.74	5.12
25	3.14	0.34	9.25	3.40	0.41	8.30	3.52	0.51	6.93	4.31	0.62	6.94	4.35	0.75	5.81
30	3.32	0.34	9.90	3.59	0.41	8.68	3.79	0.50	7.63	4.03	0.55	7.37	4.42	0.71	6.27
35	3.92	0.37	10.63	4.01	0.44	9.08	3.91	0.47	8.36	4.04	0.51	7.87	4.44	0.65	6.80
40	4.28	0.33	12.94	4.27	0.38	11.19	4.51	0.45	9.93	4.56	0.49	9.22	4.85	0.62	7.76
43	4.53	0.31	14.68	4.53	0.35	12.80	4.75	0.43	11.08	4.83	0.48	10.17	5.15	0.61	8.42
DB	LWT														
	50			55			58			60			65		
	HC	PI	COP	HC	PI	COP	HC	PI	COP	HC	PI	COP	HC	PI	COP
-25	/	/	/	/	/	/	/	/	/	/	/	/	/	/	/
-20	1.28	1.18	1.08	1.14	1.14	1.00	1.06	1.12	0.94	/	/	/	/	/	/
-15	1.52	1.12	1.36	1.25	1.00	1.25	1.24	1.10	1.13	1.23	1.17	1.05	/	/	/
-10	2.23	1.19	1.88	1.82	1.14	1.60	1.94	1.22	1.59	2.02	1.27	1.58	/	/	/
-7	2.05	0.94	2.18	1.88	0.93	2.02	2.09	1.09	1.91	2.22	1.16	1.91	/	/	/
-5	2.09	0.88	2.37	1.99	0.98	2.04	2.17	1.08	2.01	2.29	1.15	1.99	/	/	/
-2	2.14	0.85	2.51	2.08	0.92	2.26	2.30	1.07	2.14	2.44	1.19	2.05	/	/	/
0	2.24	0.84	2.68	2.21	0.88	2.51	2.45	1.07	2.29	2.61	1.22	2.14	/	/	/
2	2.39	0.87	2.75	2.48	0.95	2.61	2.68	1.12	2.39	2.81	1.25	2.24	/	/	/
5	2.58	0.88	2.94	2.79	0.99	2.81	2.95	1.14	2.59	3.05	1.25	2.44	2.33	1.14	2.04
7	3.22	0.95	3.40	3.65	1.16	3.15	3.59	1.24	2.91	3.56	1.30	2.75	2.71	1.19	2.26
10	3.19	0.90	3.54	3.60	1.07	3.35	3.56	1.16	3.05	3.53	1.24	2.85	2.87	1.17	2.44
12	3.30	0.87	3.78	3.85	1.09	3.53	3.71	1.17	3.17	3.62	1.24	2.93	2.99	1.12	2.68
14	3.33	0.85	3.93	3.94	1.08	3.64	3.76	1.16	3.25	3.64	1.22	2.99	3.02	1.07	2.81
15	3.37	0.84	4.01	4.05	1.10	3.70	3.83	1.17	3.28	3.68	1.23	3.00	3.07	1.06	2.90
19	3.59	0.83	4.35	3.77	0.95	3.97	3.48	1.00	3.50	3.29	1.03	3.18	3.27	1.00	3.27
20	3.65	0.82	4.44	3.70	0.92	4.04	3.40	0.96	3.55	3.19	0.99	3.23	/	/	/
25	4.31	0.88	4.92	3.89	0.87	4.44	3.52	0.91	3.89	3.28	0.93	3.52	/	/	/
30	4.39	0.84	5.22	4.10	0.85	4.79	3.73	0.89	4.17	3.48	0.93	3.76	/	/	/
35	4.47	0.80	5.57	4.38	0.85	5.18	/	/	/	/	/	/	/	/	/
40	4.86	0.82	5.96	/	/	/	/	/	/	/	/	/	/	/	/
43	5.19	0.84	6.20	/	/	/	/	/	/	/	/	/	/	/	/

Abbreviations:

LWT: Leaving water temperature (°C)

DB: Dry-bulb temperature for Outdoor air temperature (°C)

HC: Total heating capacity (kW)

PI: Power input (kW)

Table 2-4.2-1: Heating capacity for 6kW models

Maximum															
DB	LWT														
	25			30			35			40			45		
	HC	PI	COP	HC	PI	COP	HC	PI	COP	HC	PI	COP	HC	PI	COP
-25	2.57	1.49	1.72	2.25	1.53	1.46	2.14	1.67	1.28	1.91	1.64	1.17	1.71	1.57	1.09
-20	3.64	1.56	2.34	3.34	1.86	1.80	2.88	2.03	1.42	2.56	2.08	1.23	2.33	2.08	1.12
-15	4.43	1.49	2.97	4.19	1.53	2.73	4.00	1.71	2.34	3.61	1.87	1.93	3.08	2.01	1.53
-10	5.75	1.69	3.41	5.50	1.84	2.99	5.11	1.99	2.57	4.83	2.18	2.22	4.64	2.24	2.07
-7	6.55	1.77	3.71	6.30	1.92	3.28	6.21	2.17	2.86	5.79	2.32	2.50	5.57	2.38	2.35
-5	6.54	1.64	3.98	6.32	1.79	3.52	6.25	2.02	3.09	5.97	2.18	2.74	5.84	2.30	2.54
-2	6.32	1.49	4.24	6.14	1.58	3.88	6.11	1.80	3.40	6.07	2.04	2.97	6.01	2.26	2.65
0	6.49	1.34	4.85	6.37	1.48	4.31	6.35	1.68	3.79	6.50	1.99	3.26	6.35	2.25	2.82
2	6.68	1.35	4.96	6.48	1.48	4.38	6.53	1.69	3.86	6.65	1.89	3.52	6.58	2.23	2.95
5	7.04	1.31	5.37	6.81	1.51	4.51	6.88	1.62	4.25	6.96	1.89	3.69	6.99	2.12	3.29
7	7.58	1.29	5.87	7.46	1.55	4.81	7.41	1.56	4.76	7.13	1.79	3.99	7.13	2.00	3.58
10	7.43	1.21	6.12	7.27	1.39	5.24	7.35	1.46	5.02	7.37	1.75	4.21	7.32	1.93	3.78
12	7.33	1.17	6.25	7.26	1.31	5.54	7.34	1.42	5.16	7.51	1.70	4.42	7.40	1.86	3.98
14	7.25	1.15	6.31	7.22	1.27	5.69	7.30	1.39	5.23	7.54	1.67	4.52	7.41	1.82	4.08
15	7.17	1.13	6.35	7.20	1.24	5.82	7.26	1.38	5.28	7.58	1.64	4.61	7.43	1.78	4.16
19	6.98	1.00	6.99	7.01	1.13	6.19	7.04	1.22	5.78	7.28	1.56	4.68	7.42	1.70	4.37
20	6.93	0.97	7.15	6.97	1.11	6.28	6.98	1.18	5.91	7.21	1.54	4.70	7.42	1.68	4.42
25	6.69	0.80	8.32	6.74	0.94	7.16	6.70	1.06	6.31	6.65	1.30	5.11	7.21	1.52	4.74
30	6.74	0.71	9.53	6.83	0.85	8.02	6.83	0.94	7.27	6.56	1.09	6.01	7.05	1.40	5.05
35	6.79	0.66	10.34	6.93	0.73	9.43	6.96	0.85	8.17	6.47	0.94	6.87	6.89	1.27	5.42
40	7.26	0.64	11.42	7.37	0.73	10.15	7.28	0.81	9.02	7.12	0.97	7.34	7.34	1.20	6.12
43	7.54	0.63	12.01	7.64	0.70	10.94	7.48	0.76	9.87	7.51	0.91	8.27	7.61	1.08	7.02
DB	LWT														
	50			55			58			60			65		
	HC	PI	COP	HC	PI	COP	HC	PI	COP	HC	PI	COP	HC	PI	COP
-25	/	/	/	/	/	/	/	/	/	/	/	/	/	/	/
-20	2.19	2.04	1.07	1.84	1.86	0.99	1.63	1.74	0.94	/	/	/	/	/	/
-15	2.70	2.02	1.34	2.26	1.88	1.20	2.18	1.96	1.11	2.13	2.02	1.05	/	/	/
-10	4.13	2.41	1.72	3.80	2.24	1.69	3.51	2.28	1.54	3.32	2.30	1.44	/	/	/
-7	5.29	2.63	2.01	5.22	2.66	1.96	4.83	2.63	1.84	4.57	2.61	1.75	/	/	/
-5	5.44	2.44	2.23	5.31	2.64	2.01	4.96	2.61	1.90	4.73	2.59	1.83	/	/	/
-2	5.59	2.38	2.35	5.31	2.60	2.04	5.05	2.58	1.96	4.88	2.57	1.90	/	/	/
0	5.88	2.37	2.48	5.42	2.59	2.09	5.21	2.56	2.03	5.06	2.54	1.99	/	/	/
2	6.05	2.38	2.54	5.69	2.36	2.41	5.48	2.50	2.19	5.33	2.61	2.05	/	/	/
5	6.37	2.27	2.81	6.11	2.46	2.48	5.89	2.50	2.36	5.74	2.53	2.27	4.92	2.68	1.84
7	6.87	2.16	3.17	6.90	2.37	2.91	6.61	2.46	2.69	6.42	2.52	2.55	5.25	2.60	2.02
10	7.01	2.09	3.35	6.93	2.28	3.04	6.53	2.35	2.78	6.27	2.41	2.60	5.57	2.52	2.21
12	7.15	2.03	3.52	6.99	2.20	3.18	6.50	2.27	2.86	6.17	2.32	2.65	5.86	2.45	2.39
14	7.19	1.99	3.60	6.98	2.15	3.24	6.44	2.22	2.91	6.09	2.27	2.68	5.98	2.41	2.48
15	7.24	1.97	3.67	6.98	2.12	3.30	6.40	2.18	2.94	6.01	2.23	2.70	6.10	2.39	2.56
19	7.27	1.84	3.95	6.84	1.93	3.54	6.33	1.97	3.21	5.98	2.00	2.99	6.60	2.30	2.88
20	7.28	1.81	4.02	6.81	1.89	3.60	6.31	1.92	3.28	5.98	1.95	3.06	/	/	/
25	7.33	1.66	4.43	6.63	1.66	4.00	6.22	1.67	3.73	5.94	1.67	3.55	/	/	/
30	6.91	1.40	4.92	6.60	1.57	4.21	6.25	1.57	3.98	6.01	1.57	3.83	/	/	/
35	6.49	1.24	5.21	6.57	1.48	4.45	/	/	/	/	/	/	/	/	/
40	6.93	1.22	5.68	/	/	/	/	/	/	/	/	/	/	/	/
43	7.19	1.21	5.96	/	/	/	/	/	/	/	/	/	/	/	/

Abbreviations:

LWT: Leaving water temperature (°C)

DB: Dry-bulb temperature for Outdoor air temperature (°C)

HC: Total heating capacity (kW)

PI: Power input (kW)

Table 2-4.2-2: Heating capacity for 6kW models

Normal															
DB	LWT														
	25			30			35			40			45		
	HC	PI	COP	HC	PI	COP	HC	PI	COP	HC	PI	COP	HC	PI	COP
-25	2.37	1.35	1.76	2.07	1.37	1.51	1.95	1.50	1.30	1.77	1.51	1.17	1.61	1.49	1.08
-20	3.33	1.37	2.43	3.04	1.65	1.85	2.60	1.78	1.46	2.34	1.87	1.25	2.16	1.92	1.13
-15	4.01	1.29	3.11	3.77	1.33	2.83	3.57	1.47	2.43	3.27	1.65	1.98	2.73	1.76	1.56
-10	5.15	1.43	3.61	4.89	1.57	3.12	4.51	1.69	2.66	4.33	1.91	2.27	4.21	2.01	2.10
-7	6.24	1.62	3.86	6.05	1.80	3.36	6.00	2.00	3.00	5.61	2.21	2.54	5.40	2.25	2.40
-5	5.94	1.42	4.17	5.89	1.62	3.63	5.72	1.79	3.19	5.65	1.97	2.87	5.50	2.11	2.61
-2	5.78	1.32	4.39	5.69	1.43	3.97	5.55	1.58	3.51	5.64	1.82	3.10	5.51	2.00	2.75
0	5.99	1.20	4.98	5.86	1.33	4.40	5.74	1.47	3.89	5.94	1.75	3.40	5.68	1.93	2.94
2	6.15	1.20	5.11	5.87	1.31	4.50	5.50	1.41	3.90	5.95	1.65	3.61	5.80	1.93	3.00
5	6.43	1.16	5.56	6.06	1.31	4.64	6.16	1.39	4.42	6.36	1.68	3.78	6.13	1.78	3.45
7	6.75	1.09	6.18	6.27	1.20	5.21	6.35	1.28	4.95	6.44	1.55	4.14	6.30	1.70	3.70
10	6.68	1.02	6.52	6.32	1.15	5.49	6.49	1.26	5.17	6.59	1.50	4.39	6.62	1.73	3.83
12	6.62	0.98	6.74	6.37	1.08	5.88	6.51	1.21	5.38	6.83	1.46	4.66	6.83	1.67	4.09
14	6.56	0.95	6.87	6.36	1.04	6.09	6.48	1.18	5.50	6.91	1.44	4.82	6.89	1.63	4.23
15	6.52	0.94	6.93	6.37	1.02	6.24	6.48	1.16	5.57	7.03	1.43	4.92	6.98	1.61	4.32
19	6.37	0.83	7.67	6.24	0.93	6.68	6.31	1.03	6.14	6.65	1.32	5.02	6.85	1.50	4.56
20	6.34	0.81	7.85	6.20	0.91	6.79	6.27	1.00	6.28	6.55	1.30	5.05	6.82	1.48	4.62
25	5.97	0.65	9.21	6.12	0.78	7.79	6.13	0.91	6.75	6.15	1.11	5.53	6.76	1.35	4.99
30	6.04	0.57	10.62	6.24	0.71	8.79	6.29	0.80	7.84	6.10	0.93	6.55	6.64	1.24	5.35
35	6.14	0.53	11.60	6.38	0.61	10.41	6.46	0.73	8.87	6.07	0.81	7.54	6.55	1.13	5.79
40	6.66	0.52	12.89	6.67	0.59	11.28	6.57	0.67	9.86	6.49	0.80	8.11	6.78	1.03	6.59
43	6.97	0.51	13.65	6.98	0.57	12.24	6.80	0.63	10.86	6.91	0.75	9.20	7.09	0.93	7.61

DB	LWT														
	50			55			58			60			65		
	HC	PI	COP	HC	PI	COP	HC	PI	COP	HC	PI	COP	HC	PI	COP
-25	/	/	/	/	/	/	/	/	/	/	/	/	/	/	/
-20	2.04	1.88	1.08	1.77	1.78	1.00	1.61	1.71	0.94	/	/	/	/	/	/
-15	2.41	1.76	1.37	2.08	1.70	1.22	2.02	1.80	1.12	1.98	1.88	1.05	/	/	/
-10	3.76	2.15	1.75	3.46	2.03	1.71	3.22	2.08	1.55	3.06	2.13	1.44	/	/	/
-7	5.07	2.45	2.07	5.15	2.58	2.00	4.63	2.47	1.87	4.28	2.39	1.79	/	/	/
-5	5.11	2.25	2.27	5.08	2.47	2.06	4.64	2.40	1.93	4.35	2.35	1.85	/	/	/
-2	5.17	2.17	2.39	5.06	2.44	2.07	4.69	2.37	1.98	4.44	2.32	1.91	/	/	/
0	5.36	2.12	2.53	5.15	2.44	2.11	4.80	2.35	2.04	4.56	2.29	1.99	/	/	/
2	5.73	2.18	2.63	5.65	2.31	2.45	5.25	2.36	2.23	4.99	2.40	2.08	/	/	/
5	5.91	2.04	2.89	5.80	2.28	2.54	5.45	2.28	2.39	5.22	2.28	2.29	4.23	2.21	1.91
7	6.13	1.86	3.29	6.00	2.03	2.95	5.79	2.10	2.76	5.64	2.17	2.60	4.40	2.06	2.14
10	6.47	1.88	3.44	6.04	1.94	3.11	5.87	2.07	2.83	5.76	2.17	2.65	4.54	1.94	2.34
12	6.64	1.82	3.66	6.12	1.87	3.27	5.86	1.99	2.94	5.70	2.09	2.73	4.81	1.88	2.56
14	6.69	1.77	3.78	6.12	1.82	3.36	5.83	1.94	3.01	5.63	2.03	2.77	4.91	1.83	2.68
15	6.76	1.75	3.86	6.15	1.80	3.42	5.81	1.91	3.04	5.59	2.00	2.79	5.04	1.82	2.77
19	6.82	1.63	4.18	6.06	1.64	3.69	5.77	1.76	3.29	5.58	1.85	3.02	5.55	1.77	3.14
20	6.84	1.61	4.25	6.03	1.60	3.76	5.76	1.72	3.35	5.58	1.82	3.07	/	/	/
25	7.01	1.49	4.72	5.99	1.43	4.20	5.79	1.51	3.83	5.65	1.57	3.59	/	/	/
30	6.64	1.26	5.28	6.00	1.35	4.46	5.85	1.42	4.13	5.75	1.47	3.91	/	/	/
35	6.29	1.12	5.63	6.02	1.27	4.75	/	/	/	/	/	/	/	/	/
40	6.53	1.06	6.19	/	/	/	/	/	/	/	/	/	/	/	/
43	6.84	1.05	6.54	/	/	/	/	/	/	/	/	/	/	/	/

Abbreviations:

LWT: Leaving water temperature (°C)

DB: Dry-bulb temperature for Outdoor air temperature (°C)

HC: Total heating capacity (kW)

PI: Power input (kW)

Table 2-4.2-3: Heating capacity for 6kW models

Minimum															
DB	LWT														
	25			30			35			40			45		
	HC	PI	COP	HC	PI	COP	HC	PI	COP	HC	PI	COP	HC	PI	COP
-25	1.54	0.86	1.78	1.39	0.91	1.53	1.48	1.12	1.32	1.36	1.14	1.19	1.08	0.99	1.09
-20	2.04	0.82	2.47	1.80	0.96	1.88	1.67	1.12	1.49	1.64	1.28	1.28	1.45	1.27	1.14
-15	2.07	0.65	3.18	2.03	0.70	2.90	1.90	0.76	2.49	2.02	0.99	2.03	1.97	1.25	1.58
-10	2.28	0.62	3.71	2.14	0.67	3.21	2.02	0.74	2.74	2.51	1.07	2.34	2.81	1.32	2.14
-7	1.57	0.39	4.03	1.45	0.41	3.50	1.48	0.48	3.06	2.49	0.92	2.72	2.67	1.08	2.48
-5	1.78	0.41	4.32	1.66	0.44	3.76	1.70	0.52	3.30	2.59	0.87	2.98	2.82	1.08	2.61
-2	1.71	0.38	4.55	1.68	0.41	4.13	1.69	0.46	3.63	2.69	0.84	3.19	2.88	1.04	2.78
0	1.74	0.34	5.15	1.82	0.40	4.58	1.77	0.44	4.02	2.93	0.84	3.47	3.02	1.00	3.01
2	2.01	0.38	5.35	2.06	0.44	4.69	2.04	0.48	4.22	3.04	0.81	3.78	3.13	0.94	3.32
5	2.31	0.40	5.78	2.32	0.48	4.82	2.33	0.51	4.59	3.21	0.82	3.93	3.29	0.93	3.54
7	2.71	0.42	6.44	2.65	0.49	5.37	2.73	0.51	5.32	3.36	0.78	4.32	3.85	0.99	3.88
10	2.27	0.33	6.83	2.08	0.36	5.75	2.32	0.43	5.42	3.32	0.72	4.60	3.96	0.99	3.99
12	2.56	0.36	7.08	2.47	0.40	6.19	2.60	0.46	5.67	3.48	0.71	4.91	4.12	0.96	4.27
14	2.68	0.37	7.25	2.64	0.41	6.43	2.71	0.47	5.82	3.53	0.69	5.09	4.16	0.94	4.43
15	2.81	0.38	7.31	2.83	0.43	6.59	2.84	0.48	5.89	3.60	0.69	5.20	4.22	0.93	4.53
19	3.06	0.38	8.10	3.30	0.47	7.06	3.53	0.54	6.50	4.35	0.82	5.31	4.52	0.94	4.79
20	3.12	0.38	8.30	3.41	0.48	7.18	3.70	0.56	6.65	4.54	0.85	5.34	4.60	0.95	4.86
25	3.68	0.38	9.73	3.97	0.48	8.24	4.22	0.59	7.15	4.85	0.83	5.85	5.19	0.99	5.24
30	3.88	0.35	11.23	4.20	0.45	9.30	4.47	0.54	8.30	4.49	0.65	6.94	5.18	0.92	5.63
35	4.55	0.37	12.27	4.71	0.43	11.02	4.57	0.49	9.40	4.46	0.56	7.99	5.10	0.84	6.09
40	4.93	0.36	13.64	4.94	0.41	11.94	5.17	0.49	10.45	5.12	0.60	8.59	5.58	0.81	6.92
43	5.20	0.36	14.44	5.20	0.40	12.96	5.39	0.47	11.51	5.48	0.56	9.75	5.93	0.74	8.00
DB	LWT														
	50			55			58			60			65		
	HC	PI	COP	HC	PI	COP	HC	PI	COP	HC	PI	COP	HC	PI	COP
-25	/	/	/	/	/	/	/	/	/	/	/	/	/	/	/
-20	1.51	1.38	1.09	1.34	1.34	1.01	1.25	1.31	0.95	/	/	/	/	/	/
-15	1.86	1.35	1.39	1.53	1.24	1.24	1.52	1.34	1.14	1.51	1.41	1.07	/	/	/
-10	2.80	1.57	1.78	2.63	1.51	1.74	2.48	1.57	1.58	2.38	1.63	1.47	/	/	/
-7	2.57	1.22	2.11	2.64	1.27	2.08	2.66	1.40	1.90	2.68	1.47	1.82	/	/	/
-5	2.59	1.10	2.35	2.81	1.33	2.11	2.75	1.39	1.98	2.72	1.43	1.90	/	/	/
-2	2.75	1.12	2.46	2.80	1.31	2.13	2.83	1.40	2.03	2.85	1.45	1.96	/	/	/
0	2.99	1.15	2.59	2.85	1.31	2.17	2.94	1.41	2.09	3.00	1.47	2.04	/	/	/
2	3.18	1.17	2.73	3.13	1.24	2.52	3.21	1.39	2.30	3.26	1.51	2.16	/	/	/
5	3.43	1.15	2.98	3.46	1.32	2.62	3.53	1.43	2.46	3.58	1.52	2.36	2.85	1.42	2.01
7	4.26	1.25	3.41	4.38	1.41	3.10	4.29	1.50	2.85	4.23	1.57	2.69	3.33	1.49	2.24
10	4.22	1.18	3.57	4.37	1.35	3.23	4.27	1.45	2.94	4.20	1.53	2.75	3.55	1.46	2.43
12	4.37	1.15	3.82	4.73	1.39	3.41	4.48	1.47	3.04	4.32	1.55	2.79	3.72	1.39	2.67
14	4.40	1.11	3.96	4.86	1.38	3.52	4.55	1.47	3.10	4.34	1.54	2.82	3.77	1.34	2.80
15	4.46	1.10	4.05	5.03	1.40	3.58	4.65	1.49	3.13	4.39	1.56	2.82	3.84	1.33	2.90
19	4.68	1.07	4.38	4.65	1.20	3.88	4.31	1.25	3.44	4.08	1.30	3.15	4.14	1.26	3.28
20	4.73	1.06	4.46	4.56	1.15	3.95	4.23	1.20	3.52	4.00	1.24	3.23	/	/	/
25	5.50	1.11	4.96	4.76	1.08	4.41	4.51	1.12	4.03	4.34	1.15	3.78	/	/	/
30	5.35	0.96	5.55	4.91	1.05	4.69	4.69	1.08	4.34	4.54	1.10	4.11	/	/	/
35	5.19	0.88	5.92	5.13	1.03	4.99	/	/	/	/	/	/	/	/	/
40	5.61	0.86	6.50	/	/	/	/	/	/	/	/	/	/	/	/
43	5.97	0.87	6.87	/	/	/	/	/	/	/	/	/	/	/	/

Abbreviations:

LWT: Leaving water temperature (°C)

DB: Dry-bulb temperature for Outdoor air temperature (°C)

HC: Total heating capacity (kW)

PI: Power input (kW)

Table 2-4.3-1: Heating capacity for 8kW models

Maximum															
DB	LWT														
	25			30			35			40			45		
	HC	PI	COP	HC	PI	COP	HC	PI	COP	HC	PI	COP	HC	PI	COP
-25	4.45	1.98	2.25	4.00	2.04	1.96	3.59	2.19	1.64	3.34	2.15	1.55	2.81	2.17	1.30
-20	5.68	2.03	2.80	5.09	2.15	2.37	4.74	2.24	2.11	4.32	2.44	1.77	3.70	2.29	1.61
-15	6.90	2.07	3.34	6.44	2.24	2.87	6.11	2.51	2.43	5.57	2.47	2.26	5.29	2.65	2.00
-10	7.45	2.02	3.68	7.28	2.18	3.33	7.08	2.25	3.15	6.87	2.63	2.62	6.77	2.74	2.47
-7	7.64	2.03	3.76	7.47	2.20	3.40	7.27	2.29	3.17	7.05	2.64	2.67	6.94	2.76	2.52
-5	8.05	2.00	4.02	7.97	2.16	3.69	7.69	2.39	3.22	7.45	2.57	2.90	7.44	2.77	2.69
-2	5.03	1.18	4.25	4.94	1.27	3.89	4.96	1.39	3.57	5.61	1.82	3.08	5.67	2.04	2.78
0	8.55	1.79	4.77	8.49	2.01	4.23	8.42	2.23	3.77	8.40	2.53	3.32	8.09	2.75	2.94
2	8.66	1.67	5.20	8.65	1.92	4.50	8.48	2.14	3.95	8.50	2.50	3.40	8.31	2.74	3.04
5	9.03	1.52	5.95	8.95	1.81	4.94	8.86	1.94	4.56	8.78	2.29	3.84	8.69	2.57	3.38
7	9.51	1.45	6.54	9.20	1.73	5.32	9.11	1.80	5.07	8.85	2.12	4.18	8.98	2.35	3.82
10	10.06	1.35	7.44	9.28	1.59	5.84	8.94	1.65	5.42	8.70	2.02	4.30	8.74	2.24	3.90
12	10.00	1.23	8.13	9.37	1.45	6.48	9.05	1.58	5.74	8.92	1.89	4.72	8.86	2.14	4.15
14	9.92	1.16	8.53	9.38	1.37	6.83	9.06	1.53	5.93	8.99	1.81	4.96	8.88	2.07	4.30
15	9.86	1.12	8.79	9.39	1.33	7.09	9.09	1.51	6.04	9.07	1.77	5.12	8.91	2.03	4.38
19	9.69	0.98	9.87	9.48	1.17	8.08	9.28	1.35	6.88	9.69	0.98	9.87	9.05	1.85	4.89
20	9.65	0.95	10.14	9.51	1.14	8.33	9.33	1.32	7.09	9.45	1.59	5.93	9.08	1.81	5.02
25	9.42	0.90	10.44	9.00	1.03	8.75	8.75	1.15	7.64	9.15	1.44	6.34	9.01	1.55	5.80
30	9.18	0.83	11.03	8.49	0.93	9.16	8.17	1.05	7.78	8.85	1.29	6.84	8.93	1.43	6.23
35	9.55	0.84	11.31	8.83	0.93	9.45	8.50	1.06	8.05	9.20	1.31	7.05	9.29	1.46	6.34
40	10.03	0.87	11.57	9.27	0.93	10.02	8.92	1.05	8.49	9.66	1.32	7.31	9.75	1.51	6.46
43	10.33	0.84	12.25	9.55	0.85	11.27	9.19	1.01	9.11	9.95	1.27	7.86	10.04	1.47	6.83
DB	LWT														
	50			55			58			60			65		
	HC	PI	COP	HC	PI	COP	HC	PI	COP	HC	PI	COP	HC	PI	COP
-25	/	/	/	/	/	/	/	/	/	/	/	/	/	/	/
-20	3.17	2.26	1.41	2.62	2.10	1.25	2.28	1.98	1.15	/	/	/	/	/	/
-15	4.67	2.70	1.73	4.94	2.92	1.69	4.37	2.87	1.52	3.99	2.84	1.41	/	/	/
-10	6.32	2.88	2.20	6.07	3.05	1.99	5.54	2.94	1.88	5.19	2.86	1.81	/	/	/
-7	6.48	2.89	2.24	6.22	3.07	2.03	5.68	2.96	1.92	5.32	2.88	1.85	/	/	/
-5	7.35	2.99	2.46	6.45	2.94	2.19	6.20	2.97	2.09	6.04	3.00	2.02	/	/	/
-2	5.68	2.24	2.54	5.28	2.35	2.24	5.18	2.44	2.12	5.11	2.51	2.04	/	/	/
0	8.11	2.95	2.75	7.10	2.99	2.38	6.95	3.09	2.25	6.85	3.16	2.17	/	/	/
2	8.18	2.90	2.82	7.26	2.83	2.56	7.05	3.01	2.34	6.91	3.14	2.20	/	/	/
5	8.30	2.76	3.00	7.56	2.74	2.76	7.29	2.82	2.58	7.11	2.89	2.46	3.89	3.27	1.19
7	8.43	2.66	3.17	7.80	2.50	3.12	7.47	2.59	2.88	7.24	2.66	2.72	4.08	3.00	1.36
10	8.28	2.42	3.42	8.20	2.48	3.31	7.78	2.61	2.98	7.50	2.72	2.76	5.59	2.65	2.11
12	8.38	2.33	3.60	8.29	2.41	3.44	7.89	2.52	3.13	7.62	2.60	2.93	5.67	2.52	2.25
14	8.39	2.26	3.72	8.30	2.36	3.52	7.91	2.45	3.23	7.64	2.52	3.03	5.69	2.43	2.34
15	8.41	2.23	3.77	8.32	2.34	3.55	7.93	2.43	3.27	7.68	2.49	3.09	5.71	2.39	2.39
19	8.51	2.06	4.13	8.41	2.16	3.89	8.06	2.25	3.59	7.82	2.31	3.39	5.79	2.25	2.58
20	8.53	2.02	4.22	8.43	2.12	3.97	8.09	2.21	3.66	7.86	2.27	3.46	/	/	/
25	8.61	1.87	4.61	8.09	1.90	4.25	7.71	1.96	3.93	7.46	2.01	3.72	/	/	/
30	8.68	1.74	4.99	7.84	1.73	4.53	7.38	1.76	4.20	7.07	1.78	3.98	/	/	/
35	9.03	1.73	5.21	8.16	1.80	4.72	/	/	/	/	/	/	/	/	/
40	9.48	1.74	5.46	/	/	/	/	/	/	/	/	/	/	/	/
43	9.77	1.61	6.08	/	/	/	/	/	/	/	/	/	/	/	/

Abbreviations:

LWT: Leaving water temperature (°C)

DB: Dry-bulb temperature for Outdoor air temperature (°C)

HC: Total heating capacity (kW)

PI: Power input (kW)

Table 2-4.3-2: Heating capacity for 8kW models

Normal															
DB	LWT														
	25			30			35			40			45		
	HC	PI	COP	HC	PI	COP	HC	PI	COP	HC	PI	COP	HC	PI	COP
-25	4.11	1.79	2.29	3.68	1.82	2.03	3.27	1.96	1.67	3.10	1.99	1.56	2.64	2.05	1.29
-20	5.20	1.79	2.90	4.63	1.90	2.43	4.27	1.97	2.17	3.96	2.20	1.80	3.43	2.11	1.62
-15	6.24	1.79	3.49	5.80	1.95	2.98	5.45	2.15	2.53	5.04	2.18	2.32	4.69	2.31	2.03
-10	6.66	1.71	3.89	6.48	1.86	3.49	6.25	1.92	3.26	6.16	2.30	2.68	6.14	2.46	2.50
-7	7.27	1.83	3.97	7.11	2.01	3.53	7.00	2.19	3.20	6.71	2.40	2.79	6.60	2.59	2.55
-5	7.25	1.71	4.25	7.21	1.89	3.81	6.99	2.12	3.30	6.86	2.28	3.01	6.79	2.47	2.75
-2	7.59	1.77	4.28	7.62	1.92	3.97	7.45	2.12	3.51	7.40	2.39	3.10	7.20	2.54	2.84
0	7.60	1.55	4.89	7.78	1.79	4.34	7.67	1.98	3.88	7.74	2.30	3.37	7.16	2.35	3.05
2	7.77	1.45	5.36	7.85	1.69	4.64	7.10	1.73	4.10	7.80	2.21	3.54	7.40	2.28	3.25
5	8.09	1.31	6.17	8.08	1.58	5.13	8.08	1.71	4.73	8.03	2.04	3.93	7.62	2.15	3.54
7	8.60	1.26	6.84	8.21	1.47	5.57	8.40	1.63	5.15	8.00	1.84	4.34	8.10	2.10	3.85
10	9.05	1.14	7.93	8.12	1.33	6.12	7.89	1.41	5.58	7.77	1.74	4.48	7.91	2.00	3.95
12	9.03	1.03	8.78	8.25	1.20	6.87	8.03	1.34	5.99	8.02	1.61	4.98	8.06	1.89	4.26
14	8.98	0.97	9.26	8.26	1.13	7.30	8.05	1.29	6.23	8.09	1.54	5.26	8.09	1.82	4.44
15	8.96	0.93	9.59	8.32	1.09	7.60	8.11	1.27	6.37	8.20	1.50	5.46	8.15	1.79	4.55
19	8.85	0.82	10.83	8.43	0.97	8.72	8.32	1.14	7.30	8.85	0.82	10.83	8.32	1.63	5.11
20	8.82	0.79	11.14	8.46	0.94	9.00	8.37	1.11	7.53	8.58	1.35	6.37	8.36	1.59	5.25
25	8.39	0.73	11.55	8.17	0.86	9.52	8.01	0.98	8.18	8.47	1.23	6.86	8.44	1.38	6.11
30	8.23	0.67	12.29	7.75	0.77	10.04	7.52	0.90	8.39	8.24	1.11	7.46	8.42	1.27	6.61
35	8.63	0.68	12.68	8.13	0.78	10.43	7.89	0.90	8.74	8.64	1.12	7.74	8.83	1.30	6.77
40	9.20	0.70	13.06	8.39	0.75	11.13	8.04	0.87	9.28	8.81	1.09	8.08	9.01	1.30	6.95
43	9.56	0.69	13.92	8.72	0.69	12.61	8.36	0.83	10.03	9.16	1.05	8.74	9.36	1.26	7.40
DB	LWT														
	50			55			58			60			65		
	HC	PI	COP	HC	PI	COP	HC	PI	COP	HC	PI	COP	HC	PI	COP
-25	/	/	/	/	/	/	/	/	/	/	/	/	/	/	/
-20	2.96	2.08	1.42	2.52	2.00	1.25	2.25	1.95	1.15	/	/	/	/	/	/
-15	4.16	2.36	1.76	4.55	2.65	1.72	4.05	2.64	1.53	3.72	2.64	1.41	/	/	/
-10	5.75	2.58	2.23	5.53	2.75	2.01	5.08	2.69	1.89	4.78	2.65	1.81	/	/	/
-7	6.17	2.67	2.31	6.15	3.00	2.05	5.50	2.82	1.95	5.07	2.69	1.89	/	/	/
-5	6.59	2.61	2.52	6.06	2.72	2.23	5.71	2.70	2.12	5.48	2.69	2.04	/	/	/
-2	7.28	2.78	2.61	6.32	2.77	2.29	6.14	2.84	2.16	6.01	2.89	2.08	/	/	/
0	7.39	2.64	2.79	6.33	2.63	2.41	6.15	2.72	2.26	6.03	2.78	2.17	/	/	/
2	7.37	2.53	2.91	7.10	2.73	2.60	6.54	2.73	2.39	6.16	2.74	2.25	/	/	/
5	7.50	2.43	3.09	6.68	2.37	2.82	6.40	2.44	2.62	6.21	2.50	2.49	3.32	2.72	1.22
7	7.53	2.29	3.29	7.50	2.36	3.18	6.75	2.30	2.94	6.25	2.25	2.77	3.44	2.46	1.40
10	7.65	2.18	3.51	7.14	2.11	3.38	6.99	2.30	3.04	6.89	2.45	2.81	4.92	2.27	2.16
12	7.78	2.08	3.74	7.26	2.05	3.54	7.13	2.21	3.22	7.04	2.34	3.01	5.08	2.19	2.32
14	7.80	2.01	3.88	7.28	2.00	3.64	7.15	2.15	3.33	7.07	2.26	3.12	5.12	2.13	2.41
15	7.85	1.98	3.96	7.33	1.99	3.68	7.21	2.13	3.39	7.13	2.24	3.19	5.19	2.11	2.46
19	7.98	1.83	4.37	7.44	1.84	4.05	7.36	2.00	3.67	7.30	2.14	3.42	5.48	2.05	2.67
20	8.01	1.79	4.47	7.47	1.80	4.14	7.39	1.98	3.74	7.34	2.11	3.47	/	/	/
25	8.23	1.68	4.91	7.31	1.64	4.47	7.19	1.78	4.05	7.10	1.89	3.76	/	/	/
30	8.35	1.56	5.36	7.13	1.49	4.80	6.91	1.59	4.35	6.77	1.67	4.06	/	/	/
35	8.75	1.55	5.63	7.48	1.49	5.03	/	/	/	/	/	/	/	/	/
40	8.94	1.50	5.95	/	/	/	/	/	/	/	/	/	/	/	/
43	9.28	1.39	6.67	/	/	/	/	/	/	/	/	/	/	/	/

Abbreviations:

LWT: Leaving water temperature (°C)

DB: Dry-bulb temperature for Outdoor air temperature (°C)

HC: Total heating capacity (kW)

PI: Power input (kW)

Table 2-4.3-3: Heating capacity for 8kW models

Minimum															
DB	LWT														
	25			30			35			40			45		
	HC	PI	COP	HC	PI	COP	HC	PI	COP	HC	PI	COP	HC	PI	COP
-25	2.67	1.15	2.33	2.48	1.21	2.06	2.48	1.46	1.69	2.37	1.50	1.58	1.77	1.37	1.29
-20	3.18	1.08	2.96	2.75	1.11	2.48	2.75	1.24	2.22	2.76	1.51	1.83	2.29	1.40	1.64
-15	3.22	0.90	3.58	3.12	1.03	3.05	2.91	1.12	2.59	3.12	1.31	2.37	3.38	1.64	2.06
-10	2.96	0.74	4.01	2.84	0.79	3.59	2.80	0.84	3.35	3.57	1.30	2.76	4.10	1.61	2.55
-7	1.83	0.45	4.09	1.72	0.47	3.63	1.82	0.53	3.44	3.12	1.07	2.90	3.41	1.28	2.67
-5	2.19	0.50	4.37	2.09	0.53	3.94	2.17	0.63	3.44	3.23	1.03	3.15	3.60	1.27	2.84
-2	5.26	1.15	4.59	5.20	1.24	4.18	5.16	1.41	3.66	5.72	1.76	3.24	5.87	2.02	2.91
0	2.21	0.44	5.06	2.44	0.54	4.49	2.37	0.59	4.01	3.62	1.04	3.48	3.57	1.14	3.12
2	2.54	0.45	5.62	2.75	0.57	4.86	2.69	0.62	4.37	3.80	1.05	3.63	3.80	1.15	3.31
5	2.90	0.45	6.41	3.10	0.58	5.32	3.06	0.62	4.91	4.05	0.99	4.08	4.09	1.12	3.64
7	3.40	0.48	7.14	3.46	0.60	5.81	3.36	0.61	5.54	4.17	0.92	4.53	4.85	1.17	4.15
10	3.08	0.37	8.30	2.72	0.42	6.41	2.83	0.48	5.85	3.92	0.83	4.70	4.73	1.15	4.11
12	3.49	0.38	9.23	3.22	0.45	7.23	3.21	0.51	6.30	4.08	0.78	5.24	4.86	1.09	4.44
14	3.67	0.38	9.75	3.45	0.45	7.69	3.37	0.51	6.57	4.13	0.74	5.55	4.88	1.05	4.64
15	3.86	0.38	10.12	3.69	0.46	8.03	3.55	0.53	6.73	4.20	0.73	5.76	4.94	1.04	4.77
19	4.25	0.37	11.44	4.46	0.48	9.22	4.67	0.60	7.73	4.25	0.37	11.44	5.49	1.02	5.36
20	4.34	0.37	11.77	4.66	0.49	9.52	4.94	0.62	7.98	5.95	0.88	6.74	5.63	1.02	5.51
25	5.18	0.42	12.21	5.31	0.53	10.07	5.51	0.64	8.66	6.68	0.92	7.26	6.48	1.01	6.42
30	5.28	0.41	12.99	5.22	0.49	10.63	5.35	0.60	8.88	6.06	0.77	7.89	6.56	0.94	6.95
35	6.40	0.48	13.42	6.00	0.54	11.04	5.58	0.60	9.26	6.35	0.77	8.20	6.87	0.96	7.12
40	6.82	0.49	13.82	6.21	0.53	11.79	6.34	0.64	9.84	6.96	0.81	8.56	7.41	1.01	7.31
43	7.13	0.48	14.73	6.49	0.49	13.35	6.62	0.62	10.63	7.27	0.78	9.26	7.83	1.01	7.78
DB	LWT														
	50			55			58			60			65		
	HC	PI	COP	HC	PI	COP	HC	PI	COP	HC	PI	COP	HC	PI	COP
-25	/	/	/	/	/	/	/	/	/	/	/	/	/	/	/
-20	2.19	1.52	1.44	1.91	1.51	1.27	1.74	1.49	1.17	/	/	/	/	/	/
-15	3.22	1.80	1.79	3.36	1.92	1.75	3.04	1.96	1.56	2.84	1.99	1.43	/	/	/
-10	4.29	1.88	2.28	4.20	2.05	2.05	3.91	2.03	1.93	3.72	2.02	1.84	/	/	/
-7	3.38	1.44	2.35	3.57	1.67	2.13	3.48	1.73	2.01	3.42	1.78	1.92	/	/	/
-5	3.78	1.46	2.59	3.65	1.59	2.30	3.68	1.69	2.18	3.71	1.77	2.09	/	/	/
-2	5.90	2.20	2.69	5.40	2.23	2.42	5.33	2.37	2.25	5.29	2.47	2.14	/	/	/
0	4.12	1.44	2.86	3.80	1.54	2.47	3.96	1.71	2.32	4.06	1.83	2.22	/	/	/
2	4.26	1.41	3.02	4.01	1.51	2.66	4.13	1.67	2.47	4.21	1.80	2.34	/	/	/
5	4.47	1.41	3.18	4.28	1.47	2.91	4.37	1.62	2.70	4.43	1.73	2.56	2.47	1.99	1.24
7	5.23	1.54	3.40	4.95	1.49	3.33	4.84	1.59	3.05	4.76	1.66	2.87	2.69	1.89	1.42
10	4.99	1.37	3.65	5.17	1.47	3.51	5.08	1.61	3.16	5.02	1.72	2.92	3.80	1.72	2.22
12	5.12	1.31	3.91	5.61	1.52	3.69	5.45	1.64	3.33	5.35	1.74	3.08	3.84	1.62	2.37
14	5.14	1.27	4.06	5.78	1.52	3.80	5.59	1.63	3.43	5.46	1.72	3.18	3.82	1.55	2.47
15	5.19	1.25	4.15	5.99	1.55	3.86	5.76	1.66	3.48	5.60	1.74	3.23	3.82	1.52	2.52
19	5.47	1.19	4.58	5.72	1.34	4.25	5.49	1.43	3.84	5.33	1.49	3.57	3.85	1.40	2.74
20	5.55	1.18	4.69	5.65	1.30	4.35	5.42	1.38	3.93	5.26	1.44	3.65	/	/	/
25	6.46	1.25	5.16	5.81	1.24	4.69	5.59	1.31	4.25	5.45	1.38	3.96	/	/	/
30	6.73	1.20	5.63	5.83	1.16	5.04	5.53	1.21	4.58	5.34	1.25	4.27	/	/	/
35	7.22	1.22	5.92	6.36	1.20	5.29	/	/	/	/	/	/	/	/	/
40	7.68	1.23	6.25	/	/	/	/	/	/	/	/	/	/	/	/
43	8.11	1.16	7.01	/	/	/	/	/	/	/	/	/	/	/	/

Abbreviations:

LWT: Leaving water temperature (°C)

DB: Dry-bulb temperature for Outdoor air temperature (°C)

HC: Total heating capacity (kW)

PI: Power input (kW)



Table 2-4.4-1: Heating capacity for 10kW models

Maximum															
DB	LWT														
	25			30			35			40			45		
	HC	PI	COP	HC	PI	COP	HC	PI	COP	HC	PI	COP	HC	PI	COP
-25	4.68	2.06	2.27	4.21	2.12	1.98	3.78	2.28	1.66	3.52	2.24	1.57	2.96	2.26	1.31
-20	5.98	2.12	2.82	5.35	2.24	2.39	4.98	2.34	2.13	4.55	2.55	1.79	3.89	2.39	1.63
-15	7.26	2.15	3.37	6.78	2.34	2.90	6.43	2.62	2.46	5.86	2.57	2.28	5.57	2.76	2.02
-10	8.37	2.33	3.60	8.14	2.53	3.22	7.89	2.65	2.98	7.64	2.86	2.67	7.38	3.10	2.38
-7	8.72	2.29	3.81	8.48	2.49	3.41	8.31	0.00	3.00	7.96	2.81	2.83	7.68	3.05	2.52
-5	9.00	2.19	4.10	8.86	2.47	3.60	8.80	2.64	3.33	8.46	2.94	2.88	8.18	3.09	2.65
-2	5.59	1.29	4.34	5.47	1.44	3.81	5.59	1.58	3.53	6.22	2.01	3.09	6.24	2.28	2.74
0	9.43	1.93	4.90	9.36	2.31	4.05	9.46	2.52	3.76	9.25	2.93	3.16	8.89	3.10	2.87
2	9.72	1.88	5.18	9.57	2.21	4.34	9.72	0.00	3.93	9.58	2.86	3.35	9.24	3.07	3.01
5	10.24	1.79	5.72	10.07	2.10	4.80	10.13	2.25	4.51	10.10	2.64	3.83	9.79	2.88	3.40
7	10.49	1.77	5.94	10.28	1.97	5.21	10.32	2.09	4.93	10.45	2.50	4.18	10.28	0.00	3.72
10	11.20	1.59	7.04	10.41	1.85	5.64	10.03	1.96	5.13	9.94	2.38	4.17	9.87	2.69	3.67
12	11.36	1.50	7.58	10.56	1.74	6.08	10.17	1.84	5.53	10.08	2.24	4.49	10.01	2.53	3.95
14	11.38	1.44	7.90	10.59	1.67	6.33	10.20	1.77	5.76	10.10	2.16	4.68	10.04	2.44	4.12
15	11.42	1.41	8.10	10.62	1.64	6.49	10.23	1.73	5.90	10.13	2.11	4.80	10.07	2.39	4.22
19	10.93	1.23	8.86	10.73	1.40	7.67	10.58	1.61	6.56	10.57	1.93	5.49	10.24	2.16	4.73
20	10.81	1.19	9.05	10.76	1.35	7.96	10.67	1.59	6.72	10.68	1.89	5.66	10.28	2.12	4.86
25	9.94	1.04	9.59	9.90	1.17	8.44	9.82	1.38	7.12	9.82	1.64	6.00	9.46	1.84	5.15
30	9.77	0.96	10.15	9.07	1.03	8.79	8.90	1.12	7.95	8.85	1.32	6.72	9.92	1.61	6.15
35	10.16	0.95	10.73	9.44	1.03	9.15	9.25	1.11	8.30	9.21	1.32	6.97	10.32	1.61	6.40
40	10.67	0.93	11.52	9.91	1.01	9.81	9.71	1.15	8.47	9.67	1.32	7.34	10.84	1.60	6.79
43	10.99	0.91	12.03	10.20	0.96	10.61	10.00	1.08	9.25	9.96	1.23	8.07	11.16	1.47	7.58
DB	LWT														
	50			55			58			60			65		
	HC	PI	COP	HC	PI	COP	HC	PI	COP	HC	PI	COP	HC	PI	COP
-25	/	/	/	/	/	/	/	/	/	/	/	/	/	/	/
-20	3.34	2.35	1.42	2.75	2.18	1.26	2.40	2.06	1.16	/	/	/	/	/	/
-15	5.22	2.99	1.74	5.20	3.04	1.71	4.60	3.00	1.54	4.20	2.96	1.42	/	/	/
-10	7.03	3.31	2.13	6.67	3.58	1.86	5.90	3.33	1.77	5.38	3.15	1.71	/	/	/
-7	7.33	3.26	2.25	7.05	3.53	1.97	6.18	3.30	1.87	5.61	3.10	1.81	/	/	/
-5	8.04	3.27	2.46	7.53	3.32	2.27	6.69	3.19	2.09	6.13	3.10	1.98	/	/	/
-2	6.24	2.48	2.52	6.02	2.67	2.26	5.57	2.66	2.10	5.27	2.65	1.99	/	/	/
0	8.82	3.27	2.70	8.18	3.31	2.47	7.46	3.31	2.26	6.99	3.30	2.12	/	/	/
2	9.02	3.22	2.80	8.51	3.38	2.52	7.80	3.36	2.32	7.32	3.34	2.19	/	/	/
5	9.45	3.14	3.01	9.08	3.27	2.78	8.34	3.23	2.58	7.85	3.20	2.45	4.52	3.30	1.37
7	9.83	3.05	3.22	9.72	3.20	3.04	8.82	3.06	2.88	8.23	2.96	2.78	4.85	3.11	1.56
10	9.59	2.91	3.30	9.57	3.11	3.08	8.79	3.07	2.86	8.27	3.04	2.72	6.44	3.05	2.11
12	9.72	2.74	3.55	9.71	2.93	3.32	8.92	2.89	3.08	8.39	2.86	2.93	6.53	2.87	2.27
14	9.75	2.63	3.70	9.73	2.81	3.46	8.94	2.78	3.21	8.40	2.75	3.05	6.54	2.76	2.37
15	9.78	2.58	3.80	9.76	2.76	3.54	8.97	2.72	3.29	8.43	2.70	3.13	6.56	2.71	2.43
19	9.97	2.42	4.13	9.83	2.58	3.81	9.22	2.58	3.57	8.80	2.58	3.41	6.65	2.50	2.66
20	10.02	2.38	4.21	9.85	2.54	3.88	9.28	2.55	3.64	8.90	2.56	3.48	/	/	/
25	9.22	2.07	4.46	9.06	2.20	4.11	8.54	2.21	3.86	8.18	2.22	3.69	/	/	/
30	9.31	1.88	4.96	9.04	1.88	4.80	8.11	1.92	4.22	7.49	1.96	3.83	/	/	/
35	9.69	1.87	5.17	9.42	1.90	4.96	/	/	/	/	/	/	/	/	/
40	10.17	1.84	5.53	/	/	/	/	/	/	/	/	/	/	/	/
43	10.48	1.68	6.25	/	/	/	/	/	/	/	/	/	/	/	/

Abbreviations:

LWT: Leaving water temperature (°C)

DB: Dry-bulb temperature for Outdoor air temperature (°C)

HC: Total heating capacity (kW)

PI: Power input (kW)

Table 2-4.4-2: Heating capacity for 10kW models

Normal															
DB	LWT														
	25			30			35			40			45		
	HC	PI	COP	HC	PI	COP	HC	PI	COP	HC	PI	COP	HC	PI	COP
-25	4.33	1.87	2.32	3.87	1.89	2.05	3.45	2.05	1.68	3.26	2.07	1.57	2.78	2.14	1.30
-20	5.47	1.87	2.93	4.87	1.98	2.46	4.50	2.05	2.20	4.17	2.29	1.82	3.61	2.20	1.64
-15	6.57	1.86	3.53	6.10	2.03	3.01	5.73	2.24	2.56	5.31	2.27	2.34	4.94	2.41	2.05
-10	7.49	1.97	3.81	7.25	2.15	3.37	6.95	2.26	3.08	6.84	2.50	2.74	6.69	2.78	2.41
-7	8.28	2.11	3.92	8.18	2.33	3.51	8.00	0.00	3.05	7.43	2.54	2.93	7.35	2.88	2.55
-5	8.13	1.89	4.29	8.21	2.22	3.70	8.16	2.39	3.41	7.56	2.55	2.96	7.43	2.73	2.72
-2	8.40	1.91	4.40	8.28	2.16	3.84	8.31	2.33	3.56	8.13	2.70	3.01	7.91	2.85	2.78
0	8.33	1.64	5.06	8.25	1.99	4.15	8.33	2.16	3.86	8.23	2.57	3.20	7.87	2.65	2.97
2	8.62	1.61	5.34	8.68	1.92	4.52	8.20	0.00	4.00	8.79	2.54	3.46	7.85	2.45	3.20
5	9.09	1.53	5.95	9.00	1.81	4.99	9.07	1.94	4.68	9.23	2.35	3.92	8.58	2.41	3.55
7	10.22	1.69	6.05	9.98	1.85	5.40	10.00	0.00	4.95	10.14	2.36	4.29	10.00	0.00	3.75
10	10.06	1.34	7.50	9.12	1.54	5.91	8.85	1.68	5.28	8.88	2.04	4.35	8.94	2.40	3.72
12	10.26	1.25	8.19	9.29	1.44	6.45	9.03	1.57	5.77	9.05	1.91	4.74	9.11	2.25	4.06
14	10.30	1.20	8.58	9.33	1.38	6.76	9.06	1.50	6.04	9.08	1.83	4.97	9.14	2.15	4.25
15	10.38	1.18	8.83	9.40	1.35	6.96	9.13	1.47	6.22	9.16	1.79	5.12	9.22	2.10	4.38
19	9.98	1.03	9.72	9.54	1.15	8.27	9.49	1.36	6.96	9.59	1.63	5.89	9.41	1.90	4.94
20	9.88	0.99	9.94	9.58	1.11	8.60	9.58	1.34	7.14	9.70	1.60	6.08	9.46	1.86	5.08
25	8.86	0.83	10.61	8.98	0.98	9.18	8.99	1.18	7.63	9.10	1.40	6.49	8.87	1.63	5.43
30	8.76	0.77	11.31	8.28	0.86	9.63	8.19	0.96	8.57	8.24	1.13	7.32	9.35	1.43	6.53
35	9.19	0.76	12.03	8.69	0.86	10.10	8.59	0.95	9.01	8.65	1.13	7.65	9.81	1.43	6.84
40	9.79	0.75	13.01	8.97	0.82	10.90	8.75	0.95	9.26	8.82	1.09	8.11	10.01	1.37	7.31
43	10.17	0.74	13.67	9.32	0.79	11.87	9.10	0.89	10.18	9.16	1.02	8.98	10.40	1.27	8.21

DB	LWT														
	50			55			58			60			65		
	HC	PI	COP	HC	PI	COP	HC	PI	COP	HC	PI	COP	HC	PI	COP
-25	/	/	/	/	/	/	/	/	/	/	/	/	/	/	/
-20	3.11	2.17	1.44	2.65	2.09	1.27	2.37	2.03	1.17	/	/	/	/	/	/
-15	4.78	2.68	1.78	4.69	2.70	1.74	4.23	2.73	1.55	3.91	2.75	1.42	/	/	/
-10	6.41	2.96	2.16	6.08	3.23	1.88	5.41	3.05	1.78	4.96	2.91	1.70	/	/	/
-7	7.00	3.04	2.30	6.85	3.43	2.00	5.82	3.06	1.91	5.14	2.79	1.84	/	/	/
-5	7.08	2.81	2.52	6.89	2.98	2.31	6.03	2.83	2.13	5.46	2.71	2.02	/	/	/
-2	7.94	3.07	2.59	7.34	3.07	2.39	6.61	3.03	2.18	6.12	3.01	2.04	/	/	/
0	8.03	2.92	2.75	7.30	2.87	2.54	6.61	2.89	2.28	6.16	2.91	2.11	/	/	/
2	8.20	2.84	2.89	8.10	3.16	2.56	7.40	3.14	2.36	6.94	3.12	2.23	/	/	/
5	8.53	2.76	3.09	8.02	2.82	2.84	7.32	2.79	2.62	6.86	2.77	2.48	3.86	2.75	1.40
7	9.58	2.92	3.28	9.50	0.00	3.10	8.42	2.86	2.94	7.70	2.72	2.83	4.29	2.66	1.61
10	8.86	2.62	3.39	8.34	2.65	3.14	7.89	2.70	2.92	7.60	2.74	2.77	5.66	2.62	2.16
12	9.03	2.44	3.69	8.50	2.49	3.41	8.05	2.54	3.17	7.75	2.57	3.01	5.84	2.50	2.34
14	9.06	2.34	3.87	8.53	2.39	3.57	8.08	2.44	3.32	7.77	2.47	3.15	5.89	2.42	2.44
15	9.14	2.29	3.99	8.60	2.34	3.67	8.14	2.39	3.41	7.84	2.42	3.23	5.97	2.39	2.50
19	9.36	2.14	4.36	8.70	2.19	3.97	8.41	2.30	3.65	8.21	2.39	3.44	6.29	2.28	2.76
20	9.41	2.11	4.46	8.73	2.16	4.05	8.48	2.28	3.71	8.31	2.38	3.49	/	/	/
25	8.82	1.85	4.76	8.19	1.89	4.32	7.95	2.00	3.97	7.79	2.09	3.73	/	/	/
30	8.96	1.68	5.33	8.21	1.61	5.08	7.58	1.73	4.37	7.17	1.84	3.90	/	/	/
35	9.39	1.68	5.59	8.63	1.63	5.29	/	/	/	/	/	/	/	/	/
40	9.59	1.59	6.02	/	/	/	/	/	/	/	/	/	/	/	/
43	9.96	1.45	6.85	/	/	/	/	/	/	/	/	/	/	/	/

Abbreviations:

LWT: Leaving water temperature (°C)

DB: Dry-bulb temperature for Outdoor air temperature (°C)

HC: Total heating capacity (kW)

PI: Power input (kW)

Table 2-4.4-3: Heating capacity for 10kW models

Minimum															
DB	LWT														
	25			30			35			40			45		
	HC	PI	COP	HC	PI	COP	HC	PI	COP	HC	PI	COP	HC	PI	COP
-25	2.81	1.19	2.35	2.61	1.26	2.08	2.61	1.53	1.71	2.50	1.56	1.60	1.87	1.43	1.31
-20	3.35	1.12	2.99	2.89	1.15	2.50	2.89	1.29	2.24	2.91	1.57	1.85	2.41	1.46	1.66
-15	3.39	0.94	3.61	3.29	1.07	3.08	3.06	1.17	2.62	3.28	1.37	2.40	3.56	1.71	2.08
-10	3.32	0.85	3.91	3.18	0.92	3.47	3.11	0.98	3.17	3.97	1.41	2.82	4.47	1.82	2.46
-7	2.09	0.51	4.14	1.95	0.54	3.64	2.05	0.61	3.37	3.52	1.14	3.08	3.77	1.41	2.67
-5	2.39	0.53	4.48	2.32	0.60	3.84	2.48	0.70	3.57	3.67	1.17	3.13	3.95	1.41	2.80
-2	5.87	1.27	4.64	5.75	1.42	4.05	5.92	1.59	3.73	6.45	2.01	3.21	6.51	2.26	2.87
0	2.42	0.46	5.24	2.68	0.62	4.30	2.67	0.67	3.99	3.99	1.20	3.31	3.92	1.29	3.04
2	2.82	0.50	5.60	3.04	0.65	4.69	3.03	0.70	4.34	4.29	1.18	3.62	4.23	1.29	3.28
5	3.26	0.53	6.18	3.45	0.67	5.18	3.43	0.71	4.86	4.65	1.14	4.07	4.61	1.26	3.66
7	3.76	0.58	6.48	3.86	0.68	5.69	3.81	0.71	5.39	4.92	1.09	4.53	5.55	1.36	4.09
10	3.43	0.44	7.86	3.05	0.49	6.19	3.17	0.57	5.54	4.47	0.98	4.55	5.34	1.38	3.86
12	3.98	0.46	8.60	3.63	0.54	6.78	3.61	0.59	6.07	4.61	0.92	4.99	5.49	1.30	4.24
14	4.21	0.47	9.03	3.89	0.55	7.12	3.79	0.59	6.38	4.64	0.89	5.24	5.52	1.24	4.45
15	4.48	0.48	9.32	4.17	0.57	7.35	4.00	0.61	6.58	4.69	0.87	5.40	5.58	1.21	4.59
19	4.79	0.47	10.27	5.05	0.58	8.75	5.33	0.72	7.36	6.32	1.01	6.23	6.22	1.20	5.19
20	4.86	0.46	10.51	5.27	0.58	9.10	5.66	0.75	7.56	6.73	1.05	6.44	6.38	1.19	5.34
25	5.47	0.49	11.22	5.84	0.60	9.72	6.19	0.77	8.07	7.17	1.04	6.87	6.81	1.19	5.70
30	5.62	0.47	11.96	5.58	0.55	10.20	5.83	0.64	9.08	6.06	0.78	7.75	7.29	1.06	6.86
35	6.81	0.53	12.73	6.42	0.60	10.69	6.07	0.64	9.55	6.35	0.78	8.10	7.64	1.06	7.19
40	7.26	0.53	13.76	6.64	0.58	11.54	6.90	0.70	9.81	6.96	0.81	8.59	8.24	1.07	7.68
43	7.59	0.52	14.47	6.94	0.55	12.57	7.20	0.67	10.79	7.27	0.76	9.51	8.71	1.01	8.64
DB	LWT														
	50			55			58			60			65		
	HC	PI	COP	HC	PI	COP	HC	PI	COP	HC	PI	COP	HC	PI	COP
-25	/	/	/	/	/	/	/	/	/	/	/	/	/	/	/
-20	2.31	1.59	1.45	2.01	1.57	1.28	1.83	1.56	1.18	/	/	/	/	/	/
-15	3.39	1.88	1.81	3.53	2.00	1.76	3.20	2.04	1.57	2.98	2.07	1.44	/	/	/
-10	4.78	2.17	2.20	4.62	2.40	1.92	4.17	2.30	1.81	3.87	2.22	1.74	/	/	/
-7	3.82	1.62	2.36	3.99	1.93	2.07	3.76	1.92	1.96	3.60	1.91	1.88	/	/	/
-5	4.13	1.60	2.58	4.26	1.79	2.38	3.96	1.81	2.19	3.76	1.83	2.06	/	/	/
-2	6.49	2.43	2.68	6.32	2.59	2.44	5.84	2.60	2.24	5.52	2.61	2.11	/	/	/
0	4.48	1.59	2.82	4.38	1.68	2.61	4.24	1.81	2.34	4.14	1.91	2.17	/	/	/
2	4.74	1.58	3.00	4.72	1.74	2.71	4.58	1.85	2.47	4.48	1.94	2.31	/	/	/
5	5.08	1.60	3.18	5.14	1.76	2.92	4.99	1.85	2.70	4.89	1.92	2.55	2.87	2.02	1.42
7	6.10	1.76	3.46	6.17	1.90	3.25	5.72	1.87	3.06	5.41	1.85	2.93	3.19	1.96	1.63
10	5.78	1.64	3.52	6.04	1.85	3.27	5.74	1.89	3.04	5.54	1.92	2.88	4.38	1.98	2.22
12	5.94	1.54	3.86	6.57	1.84	3.56	6.16	1.88	3.28	5.88	1.91	3.08	4.41	1.84	2.39
14	5.97	1.47	4.05	6.78	1.82	3.74	6.31	1.85	3.42	6.00	1.87	3.20	4.39	1.76	2.50
15	6.03	1.44	4.18	7.03	1.83	3.85	6.51	1.86	3.50	6.16	1.88	3.27	4.40	1.71	2.56
19	6.42	1.40	4.58	6.69	1.60	4.17	6.27	1.64	3.83	6.00	1.67	3.59	4.42	1.56	2.83
20	6.51	1.39	4.68	6.60	1.55	4.25	6.22	1.59	3.91	5.96	1.62	3.67	/	/	/
25	6.92	1.38	5.00	6.51	1.43	4.54	6.19	1.48	4.17	5.97	1.52	3.93	/	/	/
30	7.22	1.29	5.59	6.71	1.26	5.34	6.08	1.32	4.60	5.65	1.38	4.11	/	/	/
35	7.75	1.32	5.88	7.34	1.32	5.56	/	/	/	/	/	/	/	/	/
40	8.24	1.30	6.33	/	/	/	/	/	/	/	/	/	/	/	/
43	8.70	1.21	7.20	/	/	/	/	/	/	/	/	/	/	/	/

Abbreviations:

LWT: Leaving water temperature (°C)

DB: Dry-bulb temperature for Outdoor air temperature (°C)

HC: Total heating capacity (kW)

PI: Power input (kW)

Table 2-4.5-1: Heating capacity for 12kW models

Maximum															
DB	LWT														
	25			30			35			40			45		
	HC	PI	COP	HC	PI	COP	HC	PI	COP	HC	PI	COP	HC	PI	COP
-25	6.33	2.92	2.17	5.96	2.77	2.15	5.03	2.96	1.70	4.53	3.12	1.45	4.23	3.29	1.28
-20	7.75	3.04	2.55	7.49	3.00	2.50	7.21	3.34	2.16	6.38	3.41	1.87	6.05	3.52	1.72
-15	8.95	3.13	2.85	8.66	3.27	2.65	8.36	3.41	2.45	7.93	3.62	2.19	7.39	3.95	1.87
-10	10.98	3.47	3.17	10.38	3.79	2.74	10.02	3.95	2.54	9.69	4.34	2.23	9.32	4.54	2.05
-7	12.30	3.52	3.49	10.94	3.62	3.02	11.02	3.89	2.83	10.42	4.27	2.44	10.40	4.50	2.31
-5	12.35	3.33	3.71	11.21	3.55	3.15	11.30	3.87	2.92	10.94	4.26	2.57	10.94	4.61	2.37
-2	12.04	3.11	3.87	11.28	3.28	3.44	11.30	3.56	3.17	11.29	4.07	2.77	11.46	4.46	2.57
0	12.48	2.87	4.35	12.09	3.18	3.80	11.99	3.44	3.48	12.25	4.04	3.04	12.29	4.37	2.81
2	13.36	2.80	4.78	12.73	3.11	4.09	12.64	3.45	3.66	12.87	3.93	3.28	12.83	4.40	2.92
5	14.60	2.66	5.49	13.71	3.02	4.55	13.62	3.28	4.15	13.78	3.70	3.73	13.62	4.18	3.26
7	15.45	2.57	6.00	14.67	2.93	5.01	14.57	3.11	4.69	14.80	3.57	4.14	14.51	4.00	3.63
10	14.95	2.40	6.22	14.36	2.62	5.49	14.30	2.83	5.06	14.61	3.34	4.37	14.32	3.89	3.69
12	15.10	2.17	6.96	14.59	2.40	6.08	14.39	2.74	5.25	14.84	3.26	4.55	14.52	3.71	3.92
14	15.06	2.07	7.27	14.60	2.31	6.33	14.34	2.70	5.31	14.85	3.22	4.61	14.52	3.63	4.00
15	15.12	1.97	7.67	14.70	2.21	6.65	14.36	2.65	5.43	14.96	3.17	4.72	14.61	3.53	4.14
19	14.67	1.72	8.54	14.39	1.94	7.41	14.25	2.28	6.26	14.86	2.83	5.25	14.72	3.22	4.58
20	14.56	1.66	8.76	14.32	1.88	7.60	14.22	2.20	6.47	14.84	2.75	5.39	14.75	3.15	4.69
25	14.41	1.55	9.31	14.28	1.73	8.23	14.18	1.93	7.35	14.72	2.35	6.26	14.70	2.73	5.39
30	14.64	1.45	10.12	14.20	1.62	8.75	14.35	1.85	7.76	14.69	2.22	6.63	14.73	2.63	5.59
35	15.17	1.39	10.87	14.86	1.60	9.29	14.71	1.80	8.16	15.09	2.17	6.95	14.57	2.50	5.83
40	15.69	1.41	11.10	15.59	1.59	9.82	15.48	1.79	8.65	15.96	2.17	7.36	15.34	2.44	6.29
43	16.15	1.35	11.96	15.95	1.50	10.61	15.89	1.73	9.18	16.48	2.11	7.82	15.99	2.35	6.81
DB	LWT														
	50			55			58			60			65		
	HC	PI	COP	HC	PI	COP	HC	PI	COP	HC	PI	COP	HC	PI	COP
-25	/	/	/	/	/	/	/	/	/	/	/	/	/	/	/
-20	5.36	3.55	1.51	5.08	3.63	1.40	4.90	3.68	1.33	/	/	/	/	/	/
-15	6.71	3.97	1.69	6.33	4.31	1.47	6.05	4.52	1.34	5.87	4.69	1.25	/	/	/
-10	8.96	4.62	1.94	8.60	4.79	1.79	7.46	4.97	1.50	6.70	5.13	1.30	/	/	/
-7	10.61	4.74	2.24	10.59	5.25	2.02	9.06	5.15	1.76	8.05	5.06	1.59	/	/	/
-5	10.77	4.75	2.27	10.55	5.14	2.05	9.15	5.14	1.78	8.21	5.14	1.60	/	/	/
-2	10.82	4.65	2.33	10.56	4.91	2.15	9.22	5.00	1.84	8.33	5.09	1.64	/	/	/
0	11.12	4.61	2.41	10.77	4.74	2.27	9.42	4.89	1.93	8.52	5.03	1.69	/	/	/
2	11.85	4.52	2.62	11.64	4.62	2.52	10.61	4.92	2.15	9.92	5.19	1.91	/	/	/
5	12.81	4.46	2.88	12.82	4.70	2.73	12.07	4.90	2.46	11.57	5.06	2.29	9.92	5.16	1.92
7	13.91	4.43	3.14	13.85	4.66	2.97	13.31	4.89	2.72	12.95	5.07	2.56	11.54	5.17	2.23
10	13.54	4.11	3.30	13.12	4.38	2.99	12.87	4.61	2.79	12.70	4.79	2.65	11.69	4.89	2.39
12	13.54	3.92	3.45	12.64	4.19	3.02	12.58	4.40	2.86	12.55	4.56	2.75	11.76	4.65	2.53
14	13.44	3.84	3.50	12.31	4.09	3.01	12.35	4.30	2.87	12.38	4.45	2.78	11.71	4.55	2.58
15	13.42	3.73	3.60	12.05	3.97	3.03	12.19	4.18	2.92	12.29	4.32	2.85	11.73	4.42	2.65
19	13.61	3.43	3.97	12.03	3.63	3.32	11.45	3.74	3.06	11.07	3.83	2.89	11.82	3.98	2.97
20	13.66	3.37	4.06	12.02	3.55	3.39	11.27	3.64	3.10	10.76	3.71	2.90	/	/	/
25	13.90	3.00	4.63	12.00	3.12	3.84	10.82	3.25	3.33	10.03	3.36	2.99	/	/	/
30	13.95	2.82	4.95	12.64	2.94	4.30	11.26	3.18	3.55	10.34	3.40	3.04	/	/	/
35	14.23	2.72	5.24	12.89	2.79	4.62	/	/	/	/	/	/	/	/	/
40	14.51	2.69	5.40	/	/	/	/	/	/	/	/	/	/	/	/
43	14.78	2.57	5.75	/	/	/	/	/	/	/	/	/	/	/	/

Abbreviations:

LWT: Leaving water temperature (°C)

DB: Dry-bulb temperature for Outdoor air temperature (°C)

HC: Total heating capacity (kW)

PI: Power input (kW)

Table 2-4.5-2: Heating capacity for 12kW models

Normal															
DB	LWT														
	25			30			35			40			45		
	HC	PI	COP	HC	PI	COP	HC	PI	COP	HC	PI	COP	HC	PI	COP
-25	5.36	2.32	2.30	5.12	2.23	2.29	4.24	2.37	1.79	3.88	2.57	1.51	3.66	2.82	1.30
-20	6.73	2.45	2.75	6.60	2.44	2.70	6.25	2.72	2.30	5.62	2.85	1.97	5.31	3.01	1.77
-15	7.43	2.41	3.09	7.35	2.55	2.88	7.28	2.78	2.62	6.63	2.86	2.32	6.04	3.13	1.93
-10	9.06	2.69	3.37	8.26	2.83	2.92	8.14	3.06	2.66	8.00	3.45	2.32	7.80	3.70	2.11
-7	11.09	3.11	3.57	10.29	3.26	3.15	10.00	3.33	3.00	10.14	4.06	2.50	10.20	4.25	2.40
-5	10.26	2.55	4.03	10.22	3.19	3.20	9.95	3.28	3.03	10.07	3.76	2.68	10.18	4.15	2.45
-2	9.94	2.39	4.16	9.81	2.75	3.57	9.57	2.86	3.35	9.83	3.35	2.94	10.06	3.76	2.68
0	10.23	2.21	4.63	10.05	2.51	4.01	9.79	2.62	3.74	10.11	3.11	3.25	10.23	3.46	2.96
2	10.74	2.05	5.23	9.96	2.23	4.47	9.20	0.00	3.90	10.07	2.81	3.58	10.60	0.00	3.00
5	11.77	1.95	6.05	10.77	2.18	4.94	10.57	2.35	4.50	10.83	2.65	4.08	11.08	3.16	3.51
7	12.90	1.96	6.57	12.11	2.23	5.42	12.10	2.44	4.95	12.35	2.75	4.50	12.30	0.00	3.70
10	11.82	1.72	6.88	11.23	1.87	5.99	10.88	1.97	5.51	11.26	2.34	4.81	10.91	2.74	3.99
12	11.97	1.55	7.73	11.44	1.71	6.67	10.98	1.91	5.75	11.47	2.28	5.04	11.10	2.61	4.26
14	11.97	1.48	8.10	11.47	1.65	6.96	10.96	1.88	5.83	11.51	2.25	5.11	11.12	2.55	4.36
15	12.03	1.41	8.56	11.57	1.58	7.32	11.00	1.84	5.97	11.61	2.21	5.24	11.20	2.48	4.52
19	11.58	1.21	9.60	11.23	1.37	8.22	10.82	1.56	6.93	11.43	1.94	5.88	11.19	2.22	5.03
20	11.47	1.16	9.86	11.15	1.32	8.45	10.77	1.50	7.18	11.39	1.89	6.04	11.19	2.17	5.16
25	11.42	1.09	10.47	11.19	1.22	9.15	10.81	1.33	8.15	11.37	1.46	7.79	11.22	1.89	5.93
30	11.71	1.04	11.31	11.23	1.16	9.66	11.05	1.29	8.55	11.46	1.41	8.15	11.36	1.93	5.88
35	12.36	1.02	12.09	11.97	1.17	10.21	11.55	1.32	8.78	11.99	1.60	7.49	11.45	1.86	6.17
40	13.10	1.06	12.42	12.88	1.19	10.86	12.46	1.33	9.37	13.00	1.63	7.99	12.36	1.84	6.71
43	13.73	1.02	13.47	13.41	1.14	11.81	13.03	1.30	10.01	13.68	1.60	8.54	13.12	1.80	7.31
DB	LWT														
	50			55			58			60			65		
	HC	PI	COP	HC	PI	COP	HC	PI	COP	HC	PI	COP	HC	PI	COP
-25	/	/	/	/	/	/	/	/	/	/	/	/	/	/	/
-20	4.72	3.03	1.56	4.63	3.30	1.40	4.57	3.50	1.31	/	/	/	/	/	/
-15	5.51	3.14	1.75	5.30	3.58	1.48	5.10	3.82	1.33	4.96	4.01	1.24	/	/	/
-10	7.54	3.77	2.00	7.24	3.91	1.85	6.32	4.11	1.54	5.70	4.30	1.33	/	/	/
-7	10.28	4.48	2.29	9.80	0.00	2.05	8.34	4.63	1.80	7.23	4.42	1.64	/	/	/
-5	10.15	4.37	2.32	9.96	4.72	2.11	8.33	4.57	1.82	7.24	4.44	1.63	/	/	/
-2	10.02	4.21	2.38	9.85	4.45	2.22	8.29	4.39	1.89	7.26	4.34	1.67	/	/	/
0	10.13	4.12	2.46	9.94	4.24	2.34	8.37	4.24	1.98	7.33	4.23	1.73	/	/	/
2	10.13	3.82	2.65	11.30	0.00	2.50	9.46	4.26	2.22	8.17	4.08	2.01	/	/	/
5	11.75	4.01	2.93	11.60	4.13	2.81	10.17	3.98	2.55	9.21	3.86	2.38	8.19	4.05	2.02
7	12.17	3.75	3.25	11.90	0.00	3.05	11.29	3.98	2.84	10.81	4.06	2.66	9.64	4.10	2.35
10	10.10	2.93	3.44	9.86	3.16	3.13	9.90	3.42	2.89	9.92	3.62	2.74	9.48	3.80	2.49
12	10.13	2.79	3.62	9.53	3.01	3.17	9.71	3.25	2.98	9.83	3.44	2.86	9.56	3.59	2.66
14	10.07	2.73	3.69	9.30	2.94	3.16	9.55	3.18	3.00	9.71	3.36	2.89	9.54	3.50	2.72
15	10.08	2.66	3.79	9.12	2.85	3.20	9.44	3.09	3.06	9.66	3.26	2.97	9.57	3.39	2.82
19	10.13	2.40	4.21	9.02	2.56	3.52	8.79	2.72	3.23	8.63	2.84	3.04	9.72	3.03	3.20
20	10.14	2.35	4.32	9.00	2.50	3.61	8.62	2.63	3.28	8.37	2.74	3.06	/	/	/
25	10.39	2.11	4.93	9.04	2.21	4.09	8.33	2.36	3.52	7.85	2.50	3.14	/	/	/
30	10.53	2.01	5.24	9.62	2.14	4.49	8.75	2.37	3.70	8.17	2.58	3.17	/	/	/
35	10.95	1.96	5.58	10.00	2.06	4.86	/	/	/	/	/	/	/	/	/
40	11.46	1.98	5.80	/	/	/	/	/	/	/	/	/	/	/	/
43	11.90	1.91	6.22	/	/	/	/	/	/	/	/	/	/	/	/

Abbreviations:

LWT: Leaving water temperature (°C)

DB: Dry-bulb temperature for Outdoor air temperature (°C)

HC: Total heating capacity (kW)

PI: Power input (kW)

Table 2-4.5-3: Heating capacity for 12kW models

Minimum															
DB	LWT														
	25			30			35			40			45		
	HC	PI	COP	HC	PI	COP	HC	PI	COP	HC	PI	COP	HC	PI	COP
-25	3.64	1.54	2.36	3.52	1.50	2.35	3.27	1.81	1.81	3.08	2.01	1.53	2.83	2.17	1.30
-20	4.44	1.60	2.78	4.22	1.54	2.74	4.08	1.75	2.33	3.72	1.86	2.00	3.93	2.25	1.75
-15	4.85	1.54	3.16	5.00	1.70	2.94	4.92	1.83	2.68	4.55	1.92	2.37	4.73	2.45	1.93
-10	4.67	1.34	3.49	4.48	1.48	3.03	4.36	1.59	2.74	4.39	1.84	2.38	4.85	2.25	2.15
-7	4.61	1.17	3.94	3.85	1.15	3.36	3.97	1.26	3.14	4.20	1.53	2.74	5.41	2.14	2.52
-5	4.75	1.13	4.19	4.06	1.15	3.53	4.18	1.28	3.26	4.52	1.56	2.90	5.80	2.23	2.61
-2	4.73	1.08	4.40	4.21	1.09	3.86	4.27	1.20	3.55	4.75	1.51	3.14	6.16	2.18	2.83
0	4.99	1.01	4.96	4.64	1.08	4.28	4.62	1.18	3.92	5.24	1.52	3.45	6.70	2.15	3.11
2	5.41	0.98	5.54	4.95	1.06	4.69	4.92	1.16	4.23	5.56	1.45	3.83	7.04	2.12	3.32
5	5.91	0.93	6.35	5.34	1.03	5.19	5.31	1.12	4.73	5.97	1.39	4.29	7.49	2.05	3.66
7	6.15	0.88	6.98	5.53	0.96	5.79	5.58	1.04	5.38	6.30	1.31	4.80	7.88	1.92	4.10
10	6.10	0.84	7.24	5.72	0.91	6.31	5.62	0.97	5.81	6.37	1.26	5.07	7.92	1.90	4.16
12	6.05	0.75	8.12	5.78	0.82	7.01	5.65	0.94	6.04	6.69	1.26	5.29	8.05	1.81	4.44
14	5.97	0.70	8.49	5.76	0.79	7.30	5.62	0.92	6.11	6.78	1.27	5.36	8.05	1.77	4.54
15	5.93	0.66	8.96	5.78	0.75	7.68	5.62	0.90	6.26	6.92	1.26	5.49	8.09	1.72	4.69
19	5.83	0.58	10.05	5.74	0.67	8.61	5.65	0.78	7.27	6.96	1.13	6.16	8.24	1.58	5.23
20	5.81	0.56	10.32	5.73	0.65	8.85	5.66	0.75	7.52	6.97	1.10	6.32	8.27	1.54	5.36
25	5.89	0.54	10.97	5.85	0.61	9.58	5.79	0.68	8.54	7.06	0.96	7.36	8.39	1.36	6.16
30	6.83	0.58	11.82	6.96	0.69	10.11	7.82	0.89	8.78	8.23	1.09	7.52	8.52	1.38	6.18
35	7.23	0.56	12.79	7.43	0.69	10.81	8.17	0.88	9.31	8.60	1.08	7.94	8.58	1.32	6.49
40	7.63	0.58	13.14	7.95	0.69	11.50	8.75	0.88	9.93	9.09	1.07	8.47	9.05	1.28	7.05
43	8.10	0.57	14.26	8.37	0.67	12.51	9.22	0.87	10.62	9.64	1.06	9.06	9.75	1.27	7.69
DB	LWT														
	50			55			58			60			65		
	HC	PI	COP	HC	PI	COP	HC	PI	COP	HC	PI	COP	HC	PI	COP
-25	/	/	/	/	/	/	/	/	/	/	/	/	/	/	/
-20	3.75	2.43	1.54	3.60	2.58	1.39	3.51	2.69	1.30	/	/	/	/	/	/
-15	4.63	2.64	1.75	4.43	2.98	1.49	4.31	3.21	1.34	4.22	3.39	1.25	/	/	/
-10	5.11	2.50	2.04	5.33	2.83	1.89	4.82	3.08	1.57	4.49	3.32	1.35	/	/	/
-7	5.73	2.41	2.37	6.03	2.79	2.16	5.55	2.96	1.87	5.23	3.11	1.68	/	/	/
-5	5.93	2.44	2.43	6.12	2.79	2.20	5.70	3.01	1.89	5.42	3.20	1.69	/	/	/
-2	5.95	2.35	2.53	6.12	2.66	2.30	5.78	2.95	1.96	5.56	3.20	1.74	/	/	/
0	6.12	2.31	2.65	6.23	2.58	2.42	5.94	2.90	2.05	5.75	3.18	1.81	/	/	/
2	6.66	2.32	2.87	7.10	2.68	2.65	6.89	2.97	2.32	6.76	3.22	2.10	/	/	/
5	7.30	2.32	3.15	8.08	2.71	2.98	7.95	2.97	2.68	7.87	3.18	2.48	6.99	3.33	2.10
7	7.83	2.26	3.46	8.63	2.64	3.27	8.68	2.91	2.98	8.71	3.13	2.79	8.06	3.28	2.46
10	7.76	2.13	3.63	8.30	2.54	3.27	8.53	2.82	3.03	8.68	3.03	2.87	8.28	3.17	2.61
12	8.07	2.11	3.82	8.12	2.46	3.30	8.50	2.73	3.11	8.75	2.93	2.98	8.50	3.07	2.77
14	8.15	2.10	3.88	7.95	2.41	3.30	8.41	2.69	3.13	8.71	2.89	3.02	8.54	3.02	2.83
15	8.28	2.08	3.98	7.83	2.35	3.33	8.37	2.63	3.18	8.73	2.83	3.09	8.62	2.95	2.92
19	8.48	1.92	4.42	7.89	2.15	3.67	7.91	2.35	3.36	7.92	2.50	3.16	8.97	2.73	3.29
20	8.52	1.88	4.53	7.90	2.11	3.75	7.79	2.28	3.41	7.72	2.43	3.18	/	/	/
25	8.81	1.70	5.18	8.00	1.88	4.25	7.58	2.07	3.66	7.29	2.23	3.27	/	/	/
30	8.95	1.62	5.51	8.60	1.82	4.73	7.84	2.02	3.89	7.34	2.20	3.33	/	/	/
35	9.27	1.58	5.87	8.90	1.74	5.11	/	/	/	/	/	/	/	/	/
40	9.60	1.57	6.10	/	/	/	/	/	/	/	/	/	/	/	/
43	10.00	1.53	6.54	/	/	/	/	/	/	/	/	/	/	/	/

Abbreviations:

LWT: Leaving water temperature (°C)

DB: Dry-bulb temperature for Outdoor air temperature (°C)

HC: Total heating capacity (kW)

PI: Power input (kW)

Table 2-4.6-1: Heating capacity for 14kW models

Maximum															
DB	LWT														
	25			30			35			40			45		
	HC	PI	COP	HC	PI	COP	HC	PI	COP	HC	PI	COP	HC	PI	COP
-25	7.00	3.27	2.14	6.76	3.20	2.11	5.43	3.18	1.71	4.89	3.35	1.46	4.47	3.47	1.29
-20	8.36	3.25	2.57	8.01	3.18	2.52	7.79	3.58	2.18	6.89	3.65	1.89	6.25	3.61	1.73
-15	9.61	3.40	2.82	9.47	3.61	2.62	9.22	3.80	2.43	8.57	3.95	2.17	7.63	4.12	1.85
-10	11.88	3.81	3.12	11.42	4.18	2.73	10.95	4.44	2.47	10.60	4.70	2.26	9.64	4.73	2.04
-7	13.71	4.02	3.41	12.91	4.28	3.02	12.70	4.55	2.79	12.32	4.94	2.49	11.94	5.17	2.31
-5	13.90	3.78	3.68	13.19	3.87	3.41	12.76	4.27	2.99	12.56	4.61	2.73	12.07	4.99	2.42
-2	13.69	3.61	3.79	13.01	3.61	3.60	12.51	4.04	3.09	12.45	4.38	2.84	12.21	4.90	2.49
0	14.32	3.40	4.21	13.68	3.54	3.87	13.03	4.00	3.26	13.01	4.32	3.01	12.69	4.85	2.62
2	14.69	3.20	4.59	14.14	3.44	4.11	13.61	3.94	3.46	13.46	4.23	3.18	13.32	4.84	2.75
5	15.38	2.93	5.25	14.91	3.30	4.51	14.32	3.63	3.94	14.28	3.95	3.61	14.29	4.59	3.11
7	16.27	2.81	5.80	15.55	3.15	4.94	15.46	0.00	4.49	15.60	3.86	4.04	15.65	0.00	3.46
10	15.54	2.28	6.81	15.52	2.89	5.36	14.86	3.10	4.79	15.27	3.60	4.24	14.97	4.08	3.67
12	15.49	2.14	7.23	15.41	2.76	5.58	15.08	3.02	4.99	15.61	3.59	4.35	15.30	4.04	3.79
14	15.36	2.08	7.38	15.25	2.70	5.65	15.08	2.99	5.04	15.68	3.58	4.37	15.36	4.02	3.82
15	15.32	2.01	7.62	15.18	2.62	5.79	15.17	2.94	5.16	15.83	3.56	4.45	15.50	3.98	3.89
19	14.99	1.83	8.21	14.89	2.27	6.55	14.75	2.66	5.55	15.35	3.14	4.90	15.20	3.52	4.32
20	14.90	1.78	8.35	14.81	2.20	6.74	14.64	2.59	5.65	15.23	3.04	5.01	15.12	3.42	4.42
25	14.89	1.64	9.08	14.75	1.92	7.69	14.62	2.38	6.15	14.93	2.68	5.57	14.74	2.98	4.95
30	15.25	1.55	9.82	14.81	1.80	8.21	14.86	2.10	7.09	15.06	2.42	6.22	15.00	2.80	5.36
35	16.01	1.45	11.05	15.37	1.70	9.04	14.99	1.87	8.02	15.49	2.26	6.86	15.25	2.65	5.77
40	16.22	1.40	11.62	16.41	1.59	10.29	16.21	1.89	8.57	15.96	2.20	7.26	15.75	2.59	6.08
43	16.55	1.36	12.20	16.73	1.54	10.83	16.54	1.88	8.81	16.28	2.12	7.69	16.07	2.56	6.27
DB	LWT														
	50			55			58			60			65		
	HC	PI	COP	HC	PI	COP	HC	PI	COP	HC	PI	COP	HC	PI	COP
-25	/	/	/	/	/	/	/	/	/	/	/	/	/	/	/
-20	5.42	3.61	1.50	5.14	3.87	1.33	4.97	4.06	1.23	/	/	/	/	/	/
-15	7.01	4.32	1.62	6.46	4.58	1.41	6.19	4.84	1.28	6.01	5.05	1.19	/	/	/
-10	9.07	5.01	1.81	8.72	5.21	1.67	7.53	5.26	1.43	6.73	5.30	1.27	/	/	/
-7	11.04	5.33	2.07	11.27	5.61	2.01	9.32	5.45	1.71	8.02	5.31	1.51	/	/	/
-5	11.17	5.24	2.13	11.14	5.32	2.09	9.41	5.18	1.82	8.25	5.06	1.63	/	/	/
-2	11.39	5.07	2.25	11.36	5.23	2.17	9.80	5.26	1.86	8.76	5.28	1.66	/	/	/
0	11.89	4.99	2.38	11.80	5.19	2.27	10.32	5.34	1.93	9.34	5.48	1.70	/	/	/
2	12.68	5.13	2.47	12.62	5.27	2.39	11.28	5.44	2.07	10.38	5.58	1.86	/	/	/
5	13.80	4.98	2.77	13.78	5.18	2.66	12.53	5.29	2.37	11.70	5.38	2.17	9.76	5.33	1.83
7	14.97	4.81	3.11	14.53	0.01	2.83	13.73	5.08	2.70	13.20	5.20	2.54	10.38	4.95	2.10
10	15.31	4.62	3.31	14.15	4.60	3.08	13.58	4.77	2.84	13.20	4.91	2.69	11.23	4.98	2.26
12	15.39	4.50	3.42	13.63	4.31	3.16	13.27	4.53	2.93	13.02	4.70	2.77	11.60	4.96	2.34
14	15.32	4.45	3.44	13.27	4.17	3.18	13.01	4.42	2.95	12.84	4.60	2.79	11.69	4.96	2.36
15	15.34	4.37	3.51	12.99	4.02	3.24	12.84	4.28	3.00	12.74	4.48	2.84	11.86	4.97	2.41
19	15.06	3.94	3.83	12.78	3.69	3.46	11.91	3.81	3.12	11.34	3.91	2.90	12.53	4.80	2.61
20	14.99	3.84	3.90	12.73	3.62	3.52	11.68	3.70	3.16	10.99	3.77	2.92	/	/	/
25	14.72	3.43	4.30	12.47	3.28	3.80	11.08	3.35	3.31	10.16	3.40	2.99	/	/	/
30	14.61	3.14	4.65	12.80	2.93	4.37	11.32	3.17	3.57	10.34	3.40	3.04	/	/	/
35	14.78	2.95	5.00	13.01	2.77	4.69	/	/	/	/	/	/	/	/	/
40	14.95	2.78	5.38	/	/	/	/	/	/	/	/	/	/	/	/
43	15.15	2.73	5.54	/	/	/	/	/	/	/	/	/	/	/	/

Abbreviations:

LWT: Leaving water temperature (°C)

DB: Dry-bulb temperature for Outdoor air temperature (°C)

HC: Total heating capacity (kW)

PI: Power input (kW)

Table 2-4.6-2: Heating capacity for 14kW models

Normal															
DB	LWT														
	25			30			35			40			45		
	HC	PI	COP	HC	PI	COP	HC	PI	COP	HC	PI	COP	HC	PI	COP
-25	5.85	2.57	2.27	5.71	2.54	2.25	4.57	2.55	1.79	4.19	2.76	1.51	3.88	2.97	1.30
-20	7.27	2.63	2.77	7.27	2.67	2.72	6.75	2.92	2.32	6.07	3.06	1.99	5.48	3.08	1.78
-15	8.03	2.63	3.06	7.94	2.79	2.85	7.86	3.03	2.60	7.16	3.12	2.29	6.24	3.26	1.91
-10	9.80	2.96	3.31	9.36	3.22	2.91	8.89	3.43	2.59	8.76	3.74	2.34	8.07	3.85	2.09
-7	12.45	3.50	3.56	12.19	3.94	3.09	12.00	0.00	2.85	11.87	4.46	2.66	11.70	0.00	2.35
-5	12.05	3.05	3.95	11.84	3.29	3.60	11.87	3.88	3.06	11.70	4.08	2.87	11.68	4.73	2.47
-2	11.76	2.89	4.07	11.44	3.01	3.80	11.44	3.55	3.22	11.44	3.79	3.02	11.54	4.52	2.55
0	12.20	2.70	4.52	11.79	2.89	4.08	11.72	3.40	3.45	11.79	3.65	3.23	11.74	4.36	2.69
2	11.98	2.41	4.97	11.80	2.65	4.46	11.00	0.00	3.60	11.55	3.40	3.40	11.50	0.00	2.85
5	13.40	2.39	5.61	13.08	2.71	4.82	13.01	3.17	4.10	12.62	3.26	3.87	12.70	3.85	3.30
7	15.21	2.43	6.26	14.54	2.77	5.24	14.50	0.00	4.60	14.58	3.52	4.15	14.10	0.00	3.60
10	12.29	1.63	7.53	12.14	2.07	5.85	11.31	2.17	5.22	11.77	2.52	4.67	11.41	2.87	3.97
12	12.29	1.53	8.03	12.08	1.97	6.12	11.50	2.11	5.46	12.07	2.51	4.82	11.69	2.84	4.12
14	12.20	1.49	8.22	11.98	1.93	6.21	11.53	2.08	5.53	12.14	2.50	4.85	11.76	2.83	4.16
15	12.19	1.43	8.50	11.95	1.87	6.37	11.62	2.05	5.67	12.29	2.49	4.94	11.89	2.80	4.25
19	11.83	1.28	9.22	11.62	1.60	7.27	11.20	1.82	6.15	11.81	2.15	5.48	11.55	2.43	4.75
20	11.74	1.25	9.40	11.53	1.54	7.49	11.09	1.77	6.27	11.69	2.08	5.62	11.47	2.35	4.87
25	11.80	1.15	10.22	11.56	1.35	8.55	11.15	1.63	6.82	11.53	1.66	6.93	11.25	2.06	5.46
30	12.20	1.11	10.98	11.71	1.29	9.07	11.44	1.46	7.81	11.75	1.54	7.64	11.56	2.05	5.63
35	13.05	1.06	12.28	12.39	1.25	9.93	11.77	1.36	8.63	12.31	1.67	7.39	11.99	1.96	6.10
40	13.55	1.04	13.01	13.55	1.19	11.38	13.05	1.41	9.28	13.01	1.65	7.88	12.70	1.96	6.48
43	14.06	1.02	13.75	14.07	1.17	12.06	13.56	1.41	9.61	13.51	1.61	8.40	13.19	1.96	6.73

DB	LWT														
	50			55			58			60			65		
	HC	PI	COP	HC	PI	COP	HC	PI	COP	HC	PI	COP	HC	PI	COP
-25	/	/	/	/	/	/	/	/	/	/	/	/	/	/	/
-20	4.77	3.08	1.55	4.69	3.52	1.33	4.64	3.87	1.20	/	/	/	/	/	/
-15	5.76	3.42	1.68	5.41	3.81	1.42	5.22	4.09	1.28	5.09	4.31	1.18	/	/	/
-10	7.63	4.08	1.87	7.34	4.26	1.72	6.37	4.35	1.46	5.73	4.44	1.29	/	/	/
-7	10.86	5.15	2.11	11.00	5.37	2.05	8.84	5.05	1.75	7.41	4.77	1.55	/	/	/
-5	10.78	4.99	2.16	10.83	5.13	2.11	8.87	4.82	1.84	7.57	4.56	1.66	/	/	/
-2	10.80	4.73	2.28	10.87	4.95	2.19	9.05	4.78	1.89	7.85	4.64	1.69	/	/	/
0	11.08	4.57	2.42	11.13	4.84	2.30	9.36	4.77	1.96	8.18	4.70	1.74	/	/	/
2	12.14	4.86	2.50	12.40	0.01	2.45	10.10	4.77	2.12	8.56	4.46	1.92	/	/	/
5	12.50	4.40	2.84	12.57	4.57	2.75	10.61	4.31	2.46	9.31	4.11	2.27	8.06	4.19	1.93
7	14.00	4.40	3.18	13.80	0.00	2.95	12.93	4.67	2.77	12.34	4.73	2.61	9.71	4.50	2.16
10	11.42	3.30	3.46	10.64	3.31	3.21	10.44	3.54	2.95	10.31	3.71	2.78	9.11	3.88	2.35
12	11.51	3.21	3.59	10.28	3.10	3.32	10.23	3.35	3.05	10.20	3.54	2.88	9.43	3.83	2.46
14	11.48	3.17	3.62	10.03	3.00	3.35	10.05	3.26	3.08	10.07	3.47	2.90	9.53	3.82	2.50
15	11.52	3.11	3.70	9.84	2.88	3.41	9.94	3.16	3.14	10.01	3.38	2.96	9.68	3.78	2.56
19	11.21	2.76	4.07	9.59	2.61	3.68	9.14	2.77	3.30	8.83	2.90	3.05	10.29	3.65	2.82
20	11.13	2.68	4.16	9.53	2.55	3.74	8.94	2.68	3.34	8.54	2.78	3.07	/	/	/
25	11.00	2.41	4.58	9.40	2.32	4.04	8.53	2.43	3.50	7.95	2.53	3.14	/	/	/
30	11.03	2.24	4.92	9.74	2.13	4.56	8.80	2.36	3.73	8.17	2.58	3.17	/	/	/
35	11.38	2.13	5.33	10.09	2.05	4.93	/	/	/	/	/	/	/	/	/
40	11.81	2.04	5.78	/	/	/	/	/	/	/	/	/	/	/	/
43	12.20	2.04	5.99	/	/	/	/	/	/	/	/	/	/	/	/

Abbreviations:

LWT: Leaving water temperature (°C)

DB: Dry-bulb temperature for Outdoor air temperature (°C)

HC: Total heating capacity (kW)

PI: Power input (kW)



Table 2-4.6-3: Heating capacity for 14kW models

Minimum															
DB	LWT														
	25			30			35			40			45		
	HC	PI	COP	HC	PI	COP	HC	PI	COP	HC	PI	COP	HC	PI	COP
-25	3.76	1.62	2.33	4.02	1.74	2.30	3.54	1.94	1.82	3.33	2.17	1.54	3.00	2.29	1.31
-20	4.58	1.63	2.80	4.77	1.73	2.76	4.40	1.87	2.35	4.02	1.99	2.02	4.06	2.31	1.76
-15	5.24	1.68	3.13	5.40	1.85	2.91	5.31	2.00	2.66	4.91	2.09	2.35	4.88	2.56	1.91
-10	5.05	1.47	3.44	5.08	1.68	3.02	4.76	1.79	2.66	4.80	1.99	2.41	5.01	2.35	2.13
-7	5.14	1.34	3.84	4.55	1.35	3.36	4.57	1.48	3.10	4.96	1.77	2.80	6.21	2.46	2.52
-5	5.35	1.28	4.17	4.78	1.25	3.81	4.61	1.38	3.34	5.19	1.69	3.07	6.40	2.41	2.65
-2	5.37	1.25	4.30	4.89	1.21	4.04	4.56	1.32	3.47	5.24	1.63	3.22	6.56	2.39	2.75
0	5.73	1.19	4.80	5.34	1.22	4.36	4.79	1.31	3.66	5.57	1.63	3.42	6.92	2.39	2.90
2	5.93	1.11	5.33	5.57	1.18	4.71	5.14	1.29	4.00	5.83	1.60	3.64	7.33	2.34	3.13
5	6.23	1.03	6.07	5.89	1.14	5.15	5.58	1.24	4.49	6.18	1.49	4.16	7.86	2.25	3.49
7	6.48	0.96	6.75	6.03	1.06	5.68	5.92	1.12	5.27	6.64	1.42	4.68	8.50	2.09	4.07
10	6.34	0.80	7.93	6.18	1.00	6.16	5.84	1.06	5.50	6.66	1.35	4.92	8.28	2.00	4.15
12	6.21	0.74	8.43	6.11	0.95	6.43	5.92	1.03	5.73	7.04	1.39	5.06	8.49	1.98	4.29
14	6.09	0.71	8.62	6.02	0.92	6.52	5.91	1.02	5.80	7.16	1.41	5.09	8.51	1.97	4.33
15	6.01	0.67	8.90	5.97	0.89	6.68	5.93	1.00	5.94	7.33	1.42	5.18	8.59	1.94	4.42
19	5.96	0.62	9.65	5.93	0.78	7.61	5.85	0.91	6.45	7.19	1.25	5.74	8.50	1.72	4.93
20	5.95	0.60	9.84	5.93	0.76	7.85	5.83	0.89	6.57	7.16	1.22	5.88	8.48	1.68	5.06
25	6.09	0.57	10.70	6.05	0.68	8.95	5.96	0.83	7.15	7.17	1.10	6.54	8.42	1.48	5.67
30	7.11	0.62	11.47	7.26	0.76	9.49	8.10	1.01	8.02	8.43	1.20	7.05	8.68	1.46	5.92
35	7.63	0.59	13.00	7.69	0.73	10.52	8.32	0.91	9.15	8.83	1.13	7.84	8.98	1.40	6.42
40	7.89	0.57	13.77	8.37	0.69	12.06	9.16	0.93	9.84	9.10	1.09	8.35	9.29	1.36	6.82
43	8.30	0.57	14.55	8.79	0.69	12.78	9.59	0.94	10.19	9.53	1.07	8.90	9.24	1.31	7.08
DB	LWT														
	50			55			58			60			65		
	HC	PI	COP	HC	PI	COP	HC	PI	COP	HC	PI	COP	HC	PI	COP
-25	/	/	/	/	/	/	/	/	/	/	/	/	/	/	/
-20	3.79	2.47	1.54	3.65	2.76	1.32	3.56	2.98	1.20	/	/	/	/	/	/
-15	4.84	2.87	1.68	4.52	3.17	1.43	4.41	3.44	1.28	4.33	3.65	1.19	/	/	/
-10	5.17	2.71	1.90	5.40	3.08	1.76	4.87	3.26	1.49	4.51	3.43	1.32	/	/	/
-7	5.96	2.71	2.20	6.25	2.90	2.15	5.63	3.09	1.82	5.22	3.26	1.60	/	/	/
-5	6.15	2.69	2.28	6.46	2.88	2.24	5.85	3.03	1.93	5.44	3.15	1.73	/	/	/
-2	6.30	2.61	2.41	6.62	2.83	2.34	6.12	3.07	1.99	5.78	3.28	1.76	/	/	/
0	6.61	2.58	2.57	6.90	2.81	2.46	6.46	3.12	2.07	6.17	3.39	1.82	/	/	/
2	7.18	2.62	2.74	7.73	2.94	2.63	7.29	3.20	2.28	7.00	3.43	2.04	/	/	/
5	7.86	2.59	3.03	8.68	2.98	2.91	8.24	3.20	2.58	7.95	3.38	2.35	6.88	3.44	2.00
7	8.43	2.46	3.43	9.05	2.78	3.25	8.95	3.02	2.96	8.88	3.21	2.77	7.25	3.14	2.31
10	8.77	2.40	3.65	8.96	2.67	3.36	8.99	2.91	3.09	9.02	3.10	2.91	7.95	3.23	2.46
12	9.17	2.43	3.78	8.75	2.53	3.46	8.95	2.81	3.19	9.08	3.03	3.00	8.39	3.27	2.56
14	9.29	2.44	3.81	8.57	2.46	3.49	8.85	2.76	3.21	9.04	2.99	3.03	8.53	3.29	2.59
15	9.47	2.43	3.89	8.45	2.38	3.55	8.80	2.69	3.27	9.04	2.93	3.09	8.72	3.29	2.65
19	9.38	2.20	4.27	8.38	2.19	3.83	8.22	2.39	3.43	8.11	2.56	3.17	9.49	3.27	2.90
20	9.35	2.14	4.36	8.36	2.15	3.89	8.07	2.32	3.47	7.88	2.47	3.19	/	/	/
25	9.33	1.94	4.80	8.32	1.98	4.21	7.76	2.13	3.65	7.38	2.26	3.27	/	/	/
30	9.37	1.81	5.17	8.70	1.81	4.80	7.89	2.01	3.92	7.34	2.20	3.33	/	/	/
35	9.63	1.72	5.61	8.97	1.73	5.19	/	/	/	/	/	/	/	/	/
40	9.89	1.63	6.08	/	/	/	/	/	/	/	/	/	/	/	/
43	10.25	1.63	6.30	/	/	/	/	/	/	/	/	/	/	/	/

Abbreviations:

LWT: Leaving water temperature (°C)

DB: Dry-bulb temperature for Outdoor air temperature (°C)

HC: Total heating capacity (kW)

PI: Power input (kW)

Table 2-4.7-1: Heating capacity for 16kW models

Maximum															
DB	LWT														
	25			30			35			40			45		
	HC	PI	COP	HC	PI	COP	HC	PI	COP	HC	PI	COP	HC	PI	COP
-25	7.69	4.03	1.91	7986.00	4132.04	1.93	6.61	4.01	1.65	5.89	4.43	1.33	4.96	4.21	1.18
-20	9.57	4.02	2.38	9.71	4.43	2.19	8.16	4.77	1.71	7.48	4.76	1.57	6.55	4.85	1.35
-15	11.84	4.37	2.71	11.27	4.60	2.45	10.71	4.93	2.17	10.07	5.24	1.92	9.03	5.38	1.68
-10	13.40	4.51	2.97	13.03	4.79	2.72	12.68	5.10	2.49	12.42	5.45	2.28	11.05	5.64	1.96
-7	14.34	4.59	3.13	14.09	4.89	2.88	13.87	5.19	2.67	13.84	5.55	2.50	13.13	6.02	2.18
-5	14.55	4.19	3.47	14.25	4.55	3.13	13.98	4.88	2.86	13.84	5.31	2.61	13.38	5.88	2.28
-2	14.38	3.84	3.74	13.90	4.08	3.41	13.70	4.46	3.07	13.48	4.96	2.72	13.53	5.56	2.43
0	15.09	3.49	4.33	14.46	3.85	3.75	14.27	4.27	3.34	13.85	4.80	2.88	14.06	5.33	2.64
2	15.73	3.36	4.68	15.10	3.86	3.91	14.72	0.00	3.36	14.48	4.75	3.05	14.73	5.42	2.72
5	16.79	3.24	5.19	16.53	4.07	4.06	16.07	3.98	4.04	15.64	4.56	3.43	15.88	4.96	3.20
7	17.48	3.16	5.53	16.91	3.68	4.60	16.79	3.79	4.43	16.35	4.25	3.85	16.62	0.00	3.46
10	18.01	2.99	6.02	17.76	3.58	4.96	17.58	3.71	4.74	17.07	4.31	3.96	17.33	4.72	3.67
12	18.52	2.88	6.44	18.22	3.30	5.52	18.07	3.55	5.08	17.74	4.19	4.23	18.00	4.63	3.89
14	18.65	2.83	6.60	18.31	3.19	5.75	18.18	3.49	5.22	17.94	4.14	4.33	18.21	4.60	3.96
15	18.89	2.76	6.84	18.52	3.06	6.05	18.41	3.40	5.41	18.26	4.08	4.48	18.53	4.53	4.09
19	17.55	2.25	7.79	17.15	2.49	6.89	17.04	2.82	6.05	16.77	3.36	4.99	16.59	3.92	4.24
20	17.22	2.14	8.03	16.81	2.37	7.10	16.70	2.69	6.21	16.39	3.20	5.12	16.11	3.77	4.28
25	16.48	1.86	8.86	16.19	2.23	7.26	16.24	2.34	6.94	16.15	2.78	5.81	15.73	3.23	4.87
30	15.63	1.55	10.09	15.46	1.88	8.21	15.37	2.00	7.68	15.41	2.37	6.49	15.05	2.76	5.46
35	16.57	1.53	10.82	16.35	1.81	9.01	16.31	1.94	8.42	16.23	2.36	6.87	15.88	2.79	5.68
40	16.90	1.47	11.46	17.64	1.75	10.06	17.25	1.88	9.15	17.35	2.40	7.24	16.41	2.78	5.91
43	17.24	1.46	11.84	17.99	1.71	10.51	17.59	1.88	9.37	17.70	2.39	7.41	16.74	2.70	6.20
DB	LWT														
	50			55			58			60			65		
	HC	PI	COP	HC	PI	COP	HC	PI	COP	HC	PI	COP	HC	PI	COP
-25	/	/	/	/	/	/	/	/	/	/	/	/	/	/	/
-20	5.85	4.54	1.29	5.37	4.75	1.13	5.07	4.90	1.04	/	/	/	/	/	/
-15	7.53	5.32	1.42	6.82	5.29	1.29	6.58	5.46	1.21	6.42	5.59	1.15	/	/	/
-10	9.49	5.58	1.70	8.92	5.92	1.51	7.79	5.74	1.36	7.04	5.59	1.26	/	/	/
-7	12.86	6.22	2.07	12.50	0.01	2.00	9.94	6.17	1.61	8.25	6.18	1.33	/	/	/
-5	12.95	5.82	2.22	12.60	5.92	2.13	10.21	5.94	1.72	8.62	5.97	1.45	/	/	/
-2	13.02	5.53	2.35	12.59	5.75	2.19	10.47	5.75	1.82	9.06	5.74	1.58	/	/	/
0	13.42	5.35	2.51	12.84	5.66	2.27	10.87	5.60	1.94	9.56	5.54	1.72	/	/	/
2	14.08	5.40	2.61	13.65	5.74	2.38	12.08	5.78	2.09	11.03	5.82	1.89	/	/	/
5	15.26	5.05	3.02	14.47	5.21	2.77	13.42	5.29	2.53	12.71	5.36	2.37	10.71	5.24	2.04
7	16.20	5.11	3.17	16.20	0.01	2.84	14.91	5.45	2.74	14.06	5.34	2.63	11.28	5.13	2.20
10	16.69	5.12	3.26	16.05	5.16	3.11	15.01	5.14	2.92	14.32	5.13	2.79	12.23	4.97	2.46
12	17.33	4.96	3.50	16.82	5.14	3.27	15.48	5.05	3.07	14.59	4.98	2.93	12.40	4.89	2.54
14	17.52	4.89	3.59	17.09	5.14	3.33	15.61	5.01	3.12	14.62	4.92	2.97	12.40	4.86	2.55
15	17.83	4.79	3.72	17.46	5.11	3.42	15.83	4.95	3.20	14.75	4.83	3.06	12.47	4.80	2.60
19	15.26	4.21	3.63	15.45	4.48	3.45	14.26	4.48	3.19	13.46	4.47	3.01	12.76	4.58	2.79
20	14.62	4.06	3.60	14.95	4.32	3.46	13.86	4.36	3.18	13.14	4.39	3.00	/	/	/
25	14.52	3.46	4.20	14.06	3.68	3.82	13.26	3.93	3.37	12.73	4.15	3.07	/	/	/
30	14.31	2.99	4.79	13.56	3.24	4.18	12.83	3.63	3.53	12.34	3.98	3.10	/	/	/
35	15.00	3.00	5.01	13.37	3.07	4.35	/	/	/	/	/	/	/	/	/
40	15.58	2.98	5.22	/	/	/	/	/	/	/	/	/	/	/	/
43	15.89	2.94	5.41	/	/	/	/	/	/	/	/	/	/	/	/

Abbreviations:

LWT: Leaving water temperature (°C)

DB: Dry-bulb temperature for Outdoor air temperature (°C)

HC: Total heating capacity (kW)

PI: Power input (kW)

Table 2-4.7-2: Heating capacity for 16kW models

Normal															
DB	LWT														
	25			30			35			40			45		
	HC	PI	COP	HC	PI	COP	HC	PI	COP	HC	PI	COP	HC	PI	COP
-25	6.57	3.24	2.03	6.79	3.29	2.06	5.57	3.21	1.73	5.04	3.65	1.38	4.30	3.60	1.19
-20	8.42	3.29	2.56	8.50	3.59	2.37	7.07	3.88	1.82	6.59	3.99	1.65	5.74	4.14	1.39
-15	9.89	3.37	2.93	9.35	3.52	2.66	8.80	3.79	2.32	8.41	4.14	2.03	7.38	4.26	1.73
-10	11.06	3.51	3.15	10.69	3.68	2.90	10.30	3.95	2.61	10.26	4.34	2.37	9.25	4.59	2.01
-7	13.87	4.27	3.25	13.54	4.44	3.05	13.10	0.00	2.70	13.09	4.98	2.63	12.80	0.01	2.25
-5	13.71	3.85	3.56	13.62	4.13	3.30	13.20	4.47	2.95	13.12	4.86	2.70	12.73	5.49	2.32
-2	13.00	3.35	3.88	12.90	3.57	3.62	12.67	4.03	3.14	12.60	4.44	2.84	12.58	5.05	2.49
0	13.10	2.90	4.52	13.04	3.25	4.01	12.93	3.80	3.40	12.74	4.21	3.03	12.78	4.72	2.71
2	13.25	2.61	5.07	13.10	3.18	4.12	13.00	0.00	3.45	12.72	3.97	3.20	12.70	0.00	2.85
5	14.14	2.52	5.61	13.66	3.19	4.28	13.46	3.09	4.35	13.09	3.58	3.66	13.14	3.88	3.39
7	16.96	2.87	5.91	16.14	3.16	5.11	15.90	0.00	4.50	15.74	3.99	3.94	16.00	0.00	3.50
10	14.24	2.14	6.66	13.89	2.57	5.42	13.48	2.61	5.16	13.16	3.01	4.36	13.21	3.33	3.97
12	14.54	2.03	7.16	14.28	2.32	6.17	14.03	2.52	5.58	13.72	2.93	4.68	13.76	3.26	4.22
14	14.59	1.99	7.35	14.38	2.22	6.49	14.21	2.48	5.74	13.90	2.90	4.80	13.94	3.23	4.32
15	14.73	1.93	7.63	14.57	2.11	6.89	14.48	2.43	5.97	14.18	2.85	4.98	14.21	3.19	4.46
19	13.56	1.55	8.76	13.44	1.75	7.69	13.26	1.98	6.70	12.95	2.32	5.59	12.62	2.71	4.66
20	13.27	1.47	9.04	13.16	1.67	7.89	12.95	1.88	6.88	12.65	2.20	5.75	12.22	2.59	4.71
25	12.82	1.29	9.97	12.68	1.57	8.06	12.73	1.65	7.71	12.67	1.75	7.22	12.01	2.24	5.36
30	12.51	1.11	11.29	12.23	1.35	9.06	11.83	1.40	8.47	12.41	1.55	7.98	11.83	2.06	5.74
35	13.36	1.11	12.03	13.24	1.34	9.90	12.80	1.41	9.06	13.22	1.79	7.40	12.48	2.07	6.02
40	14.11	1.10	12.83	14.57	1.31	11.13	13.88	1.40	9.91	14.14	1.80	7.86	13.22	2.10	6.30
43	14.65	1.10	13.33	15.13	1.29	11.71	14.43	1.41	10.21	14.69	1.81	8.10	13.74	2.06	6.66
DB	LWT														
	50			55			58			60			65		
	HC	PI	COP	HC	PI	COP	HC	PI	COP	HC	PI	COP	HC	PI	COP
-25	/	/	/	/	/	/	/	/	/	/	/	/	/	/	/
-20	5.15	3.88	1.33	4.89	4.33	1.13	4.74	4.68	1.01	/	/	/	/	/	/
-15	6.18	4.21	1.47	5.71	4.40	1.30	5.54	4.61	1.20	5.43	4.77	1.14	/	/	/
-10	7.98	4.55	1.75	7.51	4.83	1.55	6.60	4.75	1.39	5.99	4.69	1.28	/	/	/
-7	12.38	5.83	2.12	12.50	0.01	2.00	9.61	5.89	1.63	7.69	5.60	1.37	/	/	/
-5	12.41	5.51	2.25	9.98	4.50	2.22	8.72	4.91	1.77	7.88	5.32	1.48	/	/	/
-2	12.49	5.19	2.41	9.78	4.26	2.29	8.73	4.63	1.88	8.04	4.99	1.61	/	/	/
0	12.88	4.97	2.59	9.77	4.09	2.39	8.86	4.40	2.01	8.26	4.69	1.76	/	/	/
2	13.02	4.88	2.67	13.30	0.01	2.40	10.71	4.95	2.17	8.92	4.44	2.01	/	/	/
5	13.22	4.25	3.11	13.50	4.74	2.85	11.47	4.37	2.62	10.12	4.09	2.47	8.84	4.24	2.08
7	15.97	4.92	3.24	16.00	0.01	2.85	14.31	5.13	2.79	13.19	4.86	2.72	10.24	4.60	2.23
10	12.45	3.66	3.41	12.07	3.71	3.25	11.53	3.81	3.03	11.18	3.88	2.88	9.92	3.93	2.52
12	12.96	3.53	3.67	12.69	3.69	3.44	11.93	3.73	3.20	11.43	3.76	3.04	10.08	3.88	2.60
14	13.14	3.48	3.77	12.91	3.69	3.50	12.05	3.70	3.26	11.47	3.71	3.09	10.10	3.85	2.62
15	13.39	3.41	3.92	13.22	3.67	3.61	12.24	3.65	3.35	11.59	3.64	3.19	10.18	3.81	2.67
19	11.36	2.95	3.85	11.60	3.16	3.67	10.93	3.25	3.36	10.49	3.32	3.16	10.49	3.65	2.87
20	10.85	2.83	3.84	11.19	3.04	3.68	10.61	3.15	3.36	10.22	3.24	3.15	/	/	/
25	10.85	2.43	4.47	10.59	2.60	4.07	10.07	2.83	3.57	9.73	3.01	3.23	/	/	/
30	10.88	2.15	5.07	10.02	2.29	4.37	10.05	2.73	3.68	10.06	3.12	3.23	/	/	/
35	11.55	2.16	5.34	10.38	2.27	4.57	/	/	/	/	/	/	/	/	/
40	12.31	2.19	5.61	/	/	/	/	/	/	/	/	/	/	/	/
43	12.79	2.19	5.85	/	/	/	/	/	/	/	/	/	/	/	/

Abbreviations:

LWT: Leaving water temperature (°C)

DB: Dry-bulb temperature for Outdoor air temperature (°C)

HC: Total heating capacity (kW)

PI: Power input (kW)

Table 2-4.7-3: Heating capacity for 16kW models

Minimum															
DB	LWT														
	25			30			35			40			45		
	HC	PI	COP	HC	PI	COP	HC	PI	COP	HC	PI	COP	HC	PI	COP
-25	4.38	2.11	2.08	4.74	2.25	2.11	4.30	2.45	1.76	4.01	2.86	1.40	3.33	2.77	1.20
-20	5.31	2.04	2.60	5.58	2.33	2.40	4.61	2.50	1.85	4.36	2.60	1.68	4.25	3.10	1.37
-15	6.45	2.15	3.00	6.37	2.34	2.72	5.94	2.50	2.38	5.77	2.77	2.08	5.78	3.33	1.73
-10	5.70	1.74	3.27	5.80	1.93	3.01	5.52	2.06	2.68	5.63	2.31	2.43	5.75	2.80	2.05
-7	5.38	1.53	3.52	4.96	1.55	3.21	4.99	1.68	2.97	5.58	1.99	2.80	6.83	2.86	2.38
-5	5.60	1.43	3.93	5.16	1.47	3.50	5.17	1.62	3.20	5.72	1.94	2.94	7.09	2.84	2.50
-2	5.64	1.33	4.26	5.22	1.36	3.83	5.17	1.50	3.44	5.67	1.84	3.08	7.27	2.71	2.68
0	6.04	1.22	4.94	5.62	1.33	4.23	5.49	1.46	3.76	5.93	1.81	3.28	7.66	2.62	2.92
2	6.35	1.18	5.39	5.69	1.31	4.34	5.82	1.42	4.10	6.28	1.77	3.56	8.12	2.55	3.19
5	6.80	1.13	5.99	5.78	1.25	4.64	6.27	1.36	4.60	6.77	1.71	3.95	8.74	2.43	3.59
7	6.96	1.08	6.43	5.67	1.05	5.38	6.43	1.27	5.08	6.97	1.56	4.46	9.02	2.26	3.99
10	6.51	0.93	7.01	6.78	1.19	5.70	6.93	1.27	5.44	7.44	1.62	4.59	9.58	2.31	4.15
12	6.65	0.89	7.51	6.84	1.06	6.48	7.15	1.22	5.86	7.99	1.63	4.92	9.98	2.27	4.40
14	6.66	0.86	7.71	6.81	1.00	6.81	7.20	1.20	6.02	8.20	1.63	5.04	10.09	2.25	4.49
15	6.71	0.84	7.99	6.82	0.94	7.22	7.29	1.17	6.26	8.45	1.62	5.22	10.26	2.21	4.64
19	6.76	0.74	9.17	6.86	0.85	8.06	7.10	1.01	7.02	8.23	1.41	5.86	9.28	1.92	4.84
20	6.77	0.72	9.46	6.86	0.83	8.27	7.05	0.98	7.21	8.17	1.36	6.02	9.04	1.85	4.89
25	6.92	0.66	10.44	7.00	0.83	8.45	7.34	0.91	8.07	7.99	1.17	6.82	8.98	1.61	5.57
30	7.29	0.62	11.79	7.58	0.80	9.48	8.38	0.96	8.70	8.91	1.21	7.36	8.88	1.47	6.03
35	7.75	0.61	12.73	8.28	0.79	10.48	9.05	0.94	9.60	9.48	1.21	7.85	9.34	1.48	6.33
40	8.22	0.61	13.58	9.00	0.76	11.79	9.75	0.93	10.51	9.89	1.19	8.34	9.68	1.46	6.62
43	8.64	0.61	14.11	9.45	0.76	12.40	10.20	0.94	10.83	10.35	1.21	8.59	10.21	1.46	7.00
DB	LWT														
	50			55			58			60			65		
	HC	PI	COP	HC	PI	COP	HC	PI	COP	HC	PI	COP	HC	PI	COP
-25	/	/	/	/	/	/	/	/	/	/	/	/	/	/	/
-20	4.10	3.11	1.32	3.81	3.38	1.13	3.64	3.60	1.01	/	/	/	/	/	/
-15	5.20	3.54	1.47	4.78	3.66	1.30	4.69	3.88	1.21	4.62	4.04	1.15	/	/	/
-10	5.41	3.03	1.79	5.53	3.49	1.58	5.04	3.56	1.42	4.71	3.62	1.30	/	/	/
-7	6.94	3.17	2.19	7.11	3.27	2.17	6.06	3.53	1.72	5.36	3.80	1.41	/	/	/
-5	7.12	3.00	2.37	7.31	3.20	2.28	6.34	3.46	1.83	5.69	3.72	1.53	/	/	/
-2	7.26	2.85	2.55	7.34	3.11	2.36	6.52	3.35	1.95	5.98	3.57	1.68	/	/	/
0	7.58	2.76	2.75	7.52	3.06	2.46	6.80	3.26	2.09	6.32	3.43	1.84	/	/	/
2	8.06	2.79	2.89	8.23	3.09	2.67	7.74	3.27	2.36	7.41	3.43	2.16	/	/	/
5	8.70	2.69	3.24	9.11	3.00	3.04	8.83	3.20	2.76	8.65	3.36	2.57	7.55	3.51	2.15
7	9.01	2.58	3.49	9.96	3.13	3.19	9.66	3.22	3.00	9.46	3.29	2.87	7.87	3.41	2.31
10	9.56	2.66	3.59	10.16	2.99	3.40	9.93	3.13	3.17	9.78	3.24	3.02	8.66	3.38	2.56
12	10.34	2.68	3.86	10.82	3.02	3.58	10.44	3.13	3.34	10.18	3.21	3.17	8.97	3.39	2.65
14	10.64	2.68	3.97	11.05	3.03	3.65	10.60	3.12	3.39	10.30	3.19	3.23	9.04	3.39	2.67
15	11.00	2.67	4.12	11.35	3.02	3.75	10.82	3.10	3.49	10.47	3.16	3.32	9.17	3.37	2.72
19	9.50	2.35	4.05	10.13	2.66	3.81	9.83	2.81	3.50	9.63	2.93	3.29	9.68	3.30	2.93
20	9.12	2.26	4.03	9.82	2.57	3.83	9.58	2.74	3.50	9.42	2.87	3.28	/	/	/
25	9.20	1.96	4.69	9.38	2.22	4.23	9.17	2.47	3.71	9.04	2.69	3.36	/	/	/
30	9.25	1.74	5.33	8.95	1.95	4.59	9.01	2.32	3.88	9.05	2.66	3.40	/	/	/
35	9.77	1.74	5.61	9.23	1.92	4.81	/	/	/	/	/	/	/	/	/
40	10.30	1.75	5.90	/	/	/	/	/	/	/	/	/	/	/	/
43	10.75	1.75	6.15	/	/	/	/	/	/	/	/	/	/	/	/

Abbreviations:

LWT: Leaving water temperature (°C)

DB: Dry-bulb temperature for Outdoor air temperature (°C)

HC: Total heating capacity (kW)

PI: Power input (kW)

## 4.2 Cooling Capacity Tables (Test standard: EN14511)

Table 2-4.8: MDVA-V4WD2ER8-A cooling capacity

Maximum																								
DB	LWT																							
	5			7			10			11			15			18			20			25		
	CC	PI	EER	CC	PI	EER	CC	PI	EER	CC	PI	EER	CC	PI	EER	CC	PI	EER	CC	PI	EER	CC	PI	EER
-5	/	/	/	/	/	/	/	/	/	/	/	/	4.76	0.46	10.30	5.19	0.50	10.32	5.47	0.55	10.01	6.09	0.48	12.66
0	/	/	/	/	/	/	/	/	/	/	/	/	4.54	0.57	8.03	4.96	0.61	8.19	5.25	0.65	8.08	5.87	0.55	10.70
5	/	/	/	/	/	/	/	/	/	/	/	/	4.04	0.67	6.07	4.45	0.71	6.30	4.75	0.75	6.34	5.37	0.65	8.28
10	/	/	/	/	/	/	/	/	/	4.88	0.84	5.78	6.06	1.06	5.71	6.34	1.03	6.15	6.44	1.01	6.40	7.11	0.85	8.37
15	/	/	/	/	/	/	5.05	0.93	5.42	5.66	1.04	5.45	8.09	1.46	5.55	8.13	1.33	6.10	8.14	1.26	6.44	8.85	1.05	8.43
19	4.48	0.99	4.53	5.06	1.07	4.75	5.82	1.14	5.11	6.28	1.21	5.18	8.14	1.49	5.48	8.25	1.36	6.06	8.29	1.29	6.42	8.96	1.09	8.21
20	4.72	1.04	4.53	5.27	1.11	4.73	6.01	1.20	5.03	6.44	1.26	5.12	8.16	1.49	5.47	8.28	1.37	6.05	8.33	1.30	6.42	8.98	1.10	8.15
25	5.87	1.30	4.51	6.30	1.36	4.65	6.97	1.43	4.88	7.22	1.45	4.98	8.23	1.53	5.39	8.41	1.40	6.00	8.52	1.33	6.40	9.12	1.15	7.90
30	5.84	1.55	3.78	6.21	1.56	3.99	6.80	1.59	4.28	7.00	1.60	4.36	7.77	1.65	4.72	8.09	1.54	5.27	8.19	1.46	5.63	8.77	1.30	6.75
35	5.80	1.79	3.24	6.11	1.84	3.32	6.64	1.79	3.70	6.77	1.78	3.82	7.31	1.71	4.28	7.65	1.62	4.73	7.87	1.55	5.06	8.43	1.44	5.84
40	3.80	1.51	2.52	4.36	1.65	2.64	5.08	1.81	2.81	5.25	1.79	2.93	5.91	1.73	3.41	6.36	1.70	3.75	6.63	1.68	3.95	7.88	1.64	4.80
43	2.58	1.15	2.24	3.13	1.33	2.35	3.80	1.52	2.51	4.06	1.53	2.66	5.08	1.56	3.26	5.56	1.56	3.56	5.88	1.57	3.74	7.55	1.59	4.73
Normal																								
DB	LWT																							
	5			7			10			11			15			18			20			25		
	CC	PI	EER	CC	PI	EER	CC	PI	EER	CC	PI	EER	CC	PI	EER	CC	PI	EER	CC	PI	EER	CC	PI	EER
-5	/	/	/	/	/	/	/	/	/	/	/	/	3.83	0.33	11.74	4.18	0.35	11.97	4.45	0.37	11.92	4.95	0.35	14.10
0	/	/	/	/	/	/	/	/	/	/	/	/	3.66	0.39	9.35	4.01	0.41	9.70	4.28	0.44	9.81	4.78	0.36	13.31
5	/	/	/	/	/	/	/	/	/	/	/	/	3.23	0.48	6.68	3.56	0.50	7.07	3.81	0.52	7.29	4.36	0.45	9.77
10	/	/	/	/	/	/	/	/	/	3.53	0.58	6.04	4.87	0.77	6.29	5.08	0.73	6.91	5.19	0.70	7.37	5.79	0.59	9.89
15	/	/	/	/	/	/	3.79	0.66	5.71	4.39	0.76	5.75	6.79	1.15	5.89	6.91	1.05	6.56	7.00	0.99	7.06	7.44	0.80	9.29
19	3.48	0.73	4.76	3.92	0.79	4.97	4.64	0.86	5.42	5.08	0.92	5.51	6.80	1.16	5.88	6.99	1.07	6.51	7.14	1.03	6.96	7.74	0.86	9.04
20	3.68	0.77	4.76	4.10	0.83	4.95	4.86	0.91	5.34	5.25	0.96	5.45	6.80	1.16	5.88	7.01	1.08	6.50	7.17	1.03	6.94	7.82	0.87	8.98
25	4.65	0.97	4.78	4.98	1.02	4.88	5.72	1.10	5.18	5.97	1.13	5.29	6.96	1.21	5.74	7.27	1.13	6.45	7.44	1.07	6.98	8.05	0.91	8.85
30	4.69	1.17	4.02	4.97	1.18	4.20	5.67	1.24	4.56	5.87	1.26	4.66	6.67	1.32	5.06	7.03	1.25	5.63	7.25	1.20	6.05	7.85	1.06	7.44
35	4.51	1.36	3.32	4.70	1.36	3.45	4.81	1.20	4.01	4.80	1.16	4.15	4.77	1.01	4.70	4.50	0.82	5.50	4.87	0.85	5.71	5.69	0.89	6.42
40	3.10	1.15	2.70	3.55	1.26	2.81	4.30	1.42	3.03	4.47	1.41	3.16	5.15	1.40	3.68	5.60	1.38	4.07	5.95	1.37	4.34	7.15	1.32	5.41
43	2.12	0.91	2.33	2.45	1.02	2.41	2.99	1.15	2.59	3.20	1.16	2.76	4.04	1.18	3.43	4.58	1.21	3.79	5.04	1.25	4.04	5.97	1.15	5.18
Minimum																								
DB	LWT																							
	5			7			10			11			15			18			20			25		
	CC	PI	EER	CC	PI	EER	CC	PI	EER	CC	PI	EER	CC	PI	EER	CC	PI	EER	CC	PI	EER	CC	PI	EER
-5	/	/	/	/	/	/	/	/	/	/	/	/	2.48	0.20	12.60	2.69	0.21	12.59	2.87	0.23	12.38	3.21	0.20	15.83
0	/	/	/	/	/	/	/	/	/	/	/	/	2.37	0.24	9.92	2.59	0.26	10.09	2.77	0.27	10.09	3.11	0.23	13.40
5	/	/	/	/	/	/	/	/	/	/	/	/	1.74	0.24	7.35	1.91	0.25	7.62	2.06	0.27	7.76	2.35	0.23	10.17
10	/	/	/	/	/	/	/	/	/	2.79	0.43	6.44	2.70	0.39	6.99	2.82	0.37	7.51	2.90	0.37	7.91	3.21	0.31	10.39
15	/	/	/	/	/	/	2.32	0.38	6.04	2.59	0.42	6.09	3.64	0.58	6.29	3.58	0.50	7.10	3.50	0.45	7.80	4.25	0.41	10.32
19	1.78	0.36	4.96	1.87	0.36	5.24	2.17	0.38	5.71	2.42	0.42	5.81	3.43	0.55	6.24	3.66	0.53	6.88	3.86	0.52	7.41	4.40	0.46	9.66
20	1.86	0.38	4.95	1.93	0.37	5.20	2.13	0.38	5.62	2.38	0.41	5.74	3.38	0.54	6.23	3.68	0.54	6.83	3.95	0.54	7.32	4.44	0.47	9.50
25	2.23	0.46	4.89	2.23	0.44	5.02	2.37	0.45	5.31	2.55	0.47	5.46	3.29	0.54	6.04	3.63	0.54	6.74	3.92	0.53	7.33	4.38	0.47	9.28
30	2.23	0.54	4.10	2.21	0.51	4.35	2.33	0.49	4.73	2.49	0.51	4.85	3.12	0.59	5.30	3.48	0.59	5.89	3.79	0.59	6.38	4.23	0.55	7.72
35	2.05	0.59	3.50	2.22	0.58	3.80	2.53	0.60	4.23	2.63	0.60	4.36	3.01	0.61	4.91	3.35	0.60	5.62	3.66	0.62	5.92	4.23	0.62	6.84
40	1.40	0.52	2.69	1.66	0.58	2.86	2.01	0.64	3.12	2.11	0.65	3.26	2.52	0.66	3.82	2.87	0.68	4.19	3.18	0.71	4.50	4.07	0.74	5.51
43	0.73	0.31	2.38	1.04	0.42	2.49	1.43	0.53	2.68	1.57	0.55	2.86	2.11	0.59	3.57	2.35	0.60	3.90	2.57	0.62	4.17	3.80	0.71	5.38

Abbreviations:

LWT: Leaving water temperature (°C)

DB: Dry-bulb temperature for Outdoor air temperature (°C)

CC: Total cooling capacity (kW)

PI: Power input (kW)

Table 2-4.9: MDVA-V6WD2ER8-A cooling capacity

Maximum																										
DB	LWT																									
	5			7			10			11			15			18			20			25				
	CC	PI	EER	CC	PI	EER	CC	PI	EER	CC	PI	EER	CC	PI	EER	CC	PI	EER	CC	PI	EER	CC	PI	EER		
-5	/	/	/	/	/	/	/	/	/	/	/	/	5.27	0.59	8.93	5.91	0.57	10.42	6.38	0.55	11.53	6.77	0.64	10.62		
0	/	/	/	/	/	/	/	/	/	/	/	/	5.05	0.69	7.28	5.68	0.67	8.49	6.16	0.66	9.39	6.55	0.74	8.85		
5	/	/	/	/	/	/	/	/	/	/	/	/	4.55	0.79	5.74	5.17	0.77	6.73	5.66	0.76	7.48	6.05	0.84	7.20		
10	/	/	/	/	/	/	/	/	/	/	/	/	5.81	1.25	4.65	6.32	1.13	5.61	6.70	1.06	6.33	6.90	1.01	6.83		
15	/	/	/	/	/	/	/	/	/	/	/	/	5.89	1.10	5.33	6.33	1.18	5.38	8.09	1.46	5.55	8.13	1.33	6.10		
19	5.06	1.29	3.93	5.87	1.36	4.31	6.48	1.36	4.76	6.81	1.39	4.91	8.14	1.49	5.48	8.25	1.36	6.06	8.29	1.29	6.42	8.96	1.09	8.21		
20	5.41	1.38	3.93	6.10	1.43	4.27	6.63	1.43	4.62	6.93	1.45	4.79	8.16	1.49	5.47	8.28	1.37	6.05	8.33	1.30	6.42	8.98	1.10	8.15		
25	7.16	1.80	3.98	7.26	1.79	4.07	7.37	1.77	4.17	7.54	1.71	4.42	8.23	1.53	5.39	8.41	1.40	6.00	8.52	1.33	6.40	9.12	1.15	7.90		
30	6.50	1.85	3.51	7.15	1.95	3.67	7.29	1.90	3.84	7.39	1.84	4.02	7.77	1.65	4.72	8.09	1.54	5.27	8.19	1.46	5.63	8.77	1.30	6.75		
35	6.04	2.09	2.89	7.11	2.39	2.97	7.22	2.03	3.55	7.24	1.95	3.71	7.31	1.68	4.35	7.65	1.64	4.67	7.87	1.58	4.98	8.43	1.44	5.84		
40	3.80	1.51	2.52	4.50	1.69	2.66	5.08	1.81	2.81	5.25	1.79	2.93	5.91	1.73	3.41	6.36	1.70	3.75	6.63	1.68	3.95	7.88	1.64	4.80		
43	2.58	1.15	2.24	3.24	1.37	2.37	3.80	1.52	2.51	4.06	1.53	2.66	5.08	1.56	3.26	5.56	1.56	3.56	5.88	1.57	3.74	7.55	1.59	4.73		
Normal																										
DB	LWT																									
	5			7			10			11			15			18			20			25				
	CC	PI	EER	CC	PI	EER	CC	PI	EER	CC	PI	EER	CC	PI	EER	CC	PI	EER	CC	PI	EER	CC	PI	EER	CC	PI
-5	/	/	/	/	/	/	/	/	/	/	/	/	4.24	0.42	10.18	4.76	0.39	12.12	5.19	0.38	13.72	5498.3	424.18	12.96		
0	/	/	/	/	/	/	/	/	/	/	/	/	4.07	0.48	8.48	4.59	0.46	10.08	5.02	0.44	11.39	5.33	0.48	11.01		
5	/	/	/	/	/	/	/	/	/	/	/	/	3.64	0.58	6.31	4.13	0.55	7.56	4.54	0.53	8.61	4.91	0.58	8.49		
10	/	/	/	/	/	/	/	/	/	/	/	/	4.69	0.95	4.93	5.08	0.82	6.18	5.37	0.75	7.12	5.55	0.71	7.86		
15	/	/	/	/	/	/	/	/	/	/	/	/	4.42	0.78	5.65	4.89	0.86	5.69	6.79	1.15	5.89	6.91	1.05	6.56		
19	3.93	0.95	4.12	4.62	1.01	4.58	5.17	1.01	5.10	5.50	1.05	5.25	6.80	1.16	5.88	6.99	1.07	6.51	7.14	1.03	6.96	7.74	0.86	9.04		
20	4.22	1.02	4.14	4.84	1.07	4.54	5.36	1.08	4.96	5.65	1.10	5.14	6.80	1.16	5.88	7.01	1.08	6.50	7.17	1.03	6.94	7.82	0.87	8.98		
25	5.67	1.35	4.21	5.92	1.36	4.34	6.05	1.35	4.49	6.23	1.31	4.74	6.96	1.21	5.74	7.27	1.13	6.45	7.44	1.07	6.98	8.05	0.91	8.85		
30	5.23	1.40	3.74	5.82	1.49	3.91	6.08	1.48	4.10	6.20	1.44	4.29	6.67	1.32	5.06	7.03	1.25	5.63	7.25	1.20	6.05	7.85	1.06	7.44		
35	4.74	1.61	2.94	7.00	2.33	3.00	6.85	1.87	3.67	6.86	1.78	3.85	6.87	1.50	4.58	6.50	1.35	4.80	6.87	1.28	5.36	7.69	1.20	6.39		
40	3.10	1.15	2.70	3.74	1.31	2.86	4.30	1.42	3.03	4.47	1.41	3.16	5.15	1.40	3.68	5.60	1.38	4.07	5.95	1.37	4.34	7.15	1.32	5.41		
43	2.12	0.91	2.33	2.58	1.05	2.46	2.99	1.15	2.59	3.20	1.16	2.76	4.04	1.18	3.43	4.58	1.21	3.79	5.04	1.25	4.04	5.97	1.15	5.18		
Minimum																										
DB	LWT																									
	5			7			10			11			15			18			20			25				
	CC	PI	EER	CC	PI	EER	CC	PI	EER	CC	PI	EER	CC	PI	EER	CC	PI	EER	CC	PI	EER	CC	PI	EER	CC	PI
-5	/	/	/	/	/	/	/	/	/	/	/	/	2.75	0.25	10.92	3.07	0.24	12.69	3.35	0.23	14.26	3.57	0.27	13.17		
0	/	/	/	/	/	/	/	/	/	/	/	/	2.64	0.29	9.00	2.96	0.28	10.44	3.25	0.28	11.72	3.47	0.31	11.08		
5	/	/	/	/	/	/	/	/	/	/	/	/	1.96	0.28	6.95	2.22	0.27	8.12	2.46	0.27	9.16	2.64	0.30	8.84		
10	/	/	/	/	/	/	/	/	/	/	/	/	2.60	0.45	5.73	2.81	0.41	6.87	2.98	0.39	7.72	3.10	0.37	8.44		
15	/	/	/	/	/	/	/	/	/	/	/	/	2.71	0.45	5.99	2.89	0.48	6.05	3.64	0.58	6.29	3.58	0.50	7.10		
19	2.07	0.48	4.29	2.20	0.46	4.77	2.42	0.45	5.34	2.62	0.47	5.52	3.43	0.55	6.24	3.66	0.53	6.88	3.86	0.52	7.41	4.40	0.46	9.66		
20	2.13	0.50	4.30	2.25	0.48	4.72	2.35	0.45	5.17	2.55	0.47	5.39	3.38	0.54	6.23	3.68	0.54	6.83	3.95	0.54	7.32	4.44	0.47	9.50		
25	2.42	0.56	4.31	2.49	0.55	4.50	2.50	0.53	4.72	2.66	0.53	4.98	3.29	0.54	6.04	3.63	0.54	6.74	3.92	0.53	7.33	4.38	0.47	9.28		
30	2.48	0.65	3.81	2.49	0.61	4.05	2.49	0.58	4.30	2.62	0.58	4.50	3.12	0.59	5.30	3.48	0.59	5.89	3.79	0.59	6.38	4.23	0.55	7.72		
35	2.07	0.62	3.31	2.44	0.67	3.65	2.75	0.69	4.00	2.80	0.67	4.20	3.01	0.60	4.99	3.35	0.60	5.62	3.66	0.63	5.81	4.23	0.62	6.84		
40	1.40	0.52	2.69	1.73	0.60	2.90	2.01	0.64	3.12	2.11	0.65	3.26	2.52	0.66	3.82	2.87	0.68	4.19	3.18	0.71	4.50	4.07	0.74	5.51		
43	0.73	0.31	2.38	1.09	0.43	2.52	1.43	0.53	2.68	1.57	0.55	2.86	2.11	0.59	3.57	2.35	0.60	3.90	2.57	0.62	4.17	3.80	0.71	5.38		

Abbreviations:

LWT: Leaving water temperature (°C)

DB: Dry-bulb temperature for Outdoor air temperature (°C)

CC: Total cooling capacity (kW)

PI: Power input (kW)

Table 2-4.10: MDVA-V8WD2ER8-A cooling capacity

Maximum																										
DB	LWT																									
	5			7			10			11			15			18			20			25				
	CC	PI	EER	CC	PI	EER	CC	PI	EER	CC	PI	EER	CC	PI	EER	CC	PI	EER	CC	PI	EER	CC	PI	EER		
-5	/	/	/	/	/	/	/	/	/	/	/	/	6.39	0.63	10.07	7.40	0.70	10.51	8.21	0.76	10.82	8.74	0.71	12.31		
0	/	/	/	/	/	/	/	/	/	/	/	/	6.17	0.71	8.69	6.81	0.73	9.28	7.26	0.74	9.76	7.76	0.70	11.05		
5	/	/	/	/	/	/	/	/	/	/	/	/	5.96	0.82	7.30	6.21	0.77	8.04	6.30	0.72	8.69	6.78	0.69	9.78		
10	/	/	/	/	/	/	/	/	/	/	/	5.07	0.65	7.86	6.29	0.74	8.54	7.20	0.80	9.05	7.91	0.84	9.45	8.30	0.79	10.53
15	/	/	/	/	/	/	5.97	0.87	6.84	6.24	0.90	6.95	7.33	0.99	7.38	8.34	1.08	7.71	9.11	1.15	7.94	9.73	1.12	8.67		
19	5.52	1.09	5.08	6.31	1.19	5.30	6.84	1.19	5.74	7.11	1.21	5.88	8.17	1.27	6.45	9.25	1.39	6.63	10.07	1.50	6.73	10.87	1.51	7.18		
20	5.68	1.15	4.96	6.46	1.25	5.18	7.06	1.29	5.46	7.33	1.31	5.61	8.38	1.35	6.22	9.47	1.49	6.36	10.31	1.60	6.43	11.15	1.64	6.81		
25	6.47	1.48	4.36	7.25	1.59	4.56	7.82	1.63	4.81	8.11	1.64	4.95	9.26	1.68	5.52	10.40	1.81	5.75	11.25	1.90	5.92	12.76	2.02	6.33		
30	7.27	1.89	3.85	8.03	1.99	4.03	8.57	2.01	4.25	8.89	2.02	4.39	10.15	2.06	4.93	11.33	2.15	5.26	12.20	2.20	5.54	14.36	2.40	6.00		
35	7.39	2.37	3.12	8.20	2.55	3.21	8.77	2.31	3.80	9.06	2.31	3.93	10.21	2.31	4.43	11.13	2.37	4.69	11.74	2.40	4.89	13.59	2.50	5.42		
40	6.61	2.52	2.62	7.11	2.49	2.86	7.42	2.37	3.14	7.71	2.40	3.21	8.88	2.53	3.51	9.69	2.54	3.81	10.23	2.51	4.07	12.27	2.83	4.34		
43	5.09	2.28	2.23	5.44	2.28	2.39	5.64	2.19	2.58	5.86	2.17	2.70	6.73	2.13	3.16	7.55	2.17	3.48	8.15	2.17	3.75	10.04	2.49	4.03		
Normal																										
DB	LWT																									
	5			7			10			11			15			18			20			25				
	CC	PI	EER	CC	PI	EER	CC	PI	EER	CC	PI	EER	CC	PI	EER	CC	PI	EER	CC	PI	EER	CC	PI	EER	CC	PI
-5	/	/	/	/	/	/	/	/	/	/	/	/	5.14	0.45	11.38	5.97	0.50	12.01	6.68	0.53	12.50	7.10	0.51	14.03		
0	/	/	/	/	/	/	/	/	/	/	/	/	4.98	0.50	9.94	5.50	0.51	10.69	5.91	0.52	11.31	6.31	0.49	12.86		
5	/	/	/	/	/	/	/	/	/	/	/	/	4.77	0.60	7.96	4.96	0.56	8.88	5.05	0.52	9.69	5.50	0.51	10.76		
10	/	/	/	/	/	/	/	/	/	/	4.10	0.49	8.42	5.05	0.54	9.32	5.77	0.58	10.00	6.37	0.60	10.55	6.75	0.58	11.60	
15	/	/	/	/	/	/	4.48	0.62	7.24	4.82	0.65	7.36	6.16	0.79	7.83	7.07	0.85	8.32	7.83	0.90	8.70	8.17	0.86	9.55		
19	4.29	0.80	5.34	4.98	0.88	5.64	5.46	0.89	6.14	5.74	0.91	6.29	6.82	0.99	6.92	7.82	1.09	7.15	8.66	1.19	7.30	9.40	1.19	7.91		
20	4.43	0.85	5.21	5.12	0.93	5.52	5.71	0.97	5.86	5.97	0.99	6.03	6.99	1.04	6.69	8.01	1.17	6.86	8.87	1.28	6.95	9.71	1.29	7.50		
25	5.13	1.11	4.61	5.83	1.20	4.87	6.42	1.24	5.17	6.70	1.26	5.31	7.84	1.33	5.87	8.92	1.44	6.20	9.82	1.52	6.46	11.26	1.59	7.09		
30	5.84	1.42	4.10	6.56	1.52	4.31	7.14	1.57	4.54	7.45	1.59	4.69	8.71	1.65	5.28	9.85	1.74	5.65	10.80	1.82	5.94	12.86	1.95	6.61		
35	5.75	1.79	3.20	7.45	2.22	3.35	7.70	1.89	4.07	7.82	1.86	4.21	8.32	1.74	4.77	8.30	1.64	5.05	10.25	1.95	5.26	12.39	2.09	5.94		
40	5.40	1.92	2.81	5.89	1.91	3.08	6.27	1.86	3.38	6.56	1.90	3.46	7.73	2.04	3.79	8.54	2.06	4.15	9.18	2.06	4.47	11.14	2.28	4.89		
43	4.18	1.80	2.32	4.35	1.75	2.49	4.44	1.66	2.67	4.62	1.65	2.80	5.36	1.61	3.32	6.23	1.68	3.71	6.98	1.72	4.06	7.94	1.80	4.41		
Minimum																										
DB	LWT																									
	5			7			10			11			15			18			20			25				
	CC	PI	EER	CC	PI	EER	CC	PI	EER	CC	PI	EER	CC	PI	EER	CC	PI	EER	CC	PI	EER	CC	PI	EER	CC	PI
-5	/	/	/	/	/	/	/	/	/	/	/	/	3.33	0.28	11.86	3.84	0.31	12.42	4.31	0.33	12.89	4.60	0.31	14.71		
0	/	/	/	/	/	/	/	/	/	/	/	/	3.23	0.31	10.38	3.55	0.32	11.13	3.83	0.32	11.79	4.11	0.31	13.34		
5	/	/	/	/	/	/	/	/	/	/	/	/	2.57	0.30	8.55	2.67	0.28	9.46	2.74	0.27	10.29	2.96	0.26	11.57		
10	/	/	/	/	/	/	/	/	/	/	2.27	0.25	9.25	2.80	0.28	10.11	3.20	0.30	10.75	3.56	0.31	11.31	3.75	0.30	12.59	
15	/	/	/	/	/	/	2.75	0.36	7.69	2.86	0.37	7.82	3.30	0.39	8.37	3.63	0.40	9.03	3.92	0.41	9.62	4.67	0.44	10.61		
19	2.19	0.40	5.55	2.34	0.40	5.87	2.55	0.40	6.43	2.73	0.41	6.61	3.44	0.47	7.35	4.09	0.54	7.60	4.69	0.60	7.79	5.34	0.63	8.47		
20	2.24	0.41	5.42	2.38	0.42	5.73	2.50	0.41	6.12	2.69	0.43	6.31	3.47	0.49	7.09	4.20	0.58	7.24	4.88	0.67	7.33	5.51	0.69	7.93		
25	2.46	0.52	4.73	2.57	0.51	5.05	2.66	0.49	5.43	2.87	0.51	5.58	3.71	0.60	6.18	4.47	0.69	6.51	5.18	0.76	6.78	6.12	0.82	7.44		
30	2.78	0.66	4.19	2.86	0.64	4.45	2.93	0.62	4.76	3.16	0.64	4.91	4.08	0.74	5.53	4.89	0.82	5.93	5.64	0.90	6.28	6.92	1.01	6.86		
35	2.62	0.74	3.54	2.99	0.77	3.89	3.34	0.78	4.28	3.51	0.79	4.45	4.21	0.82	5.12	4.86	0.90	5.43	5.46	0.96	5.70	6.82	1.07	6.36		
40	2.44	0.87	2.80	2.70	0.86	3.12	2.94	0.84	3.48	3.11	0.87	3.57	3.79	0.97	3.93	4.38	1.02	4.30	4.91	1.06	4.64	6.34	1.28	4.97		
43	1.43	0.60	2.37	1.78	0.70	2.55	2.12	0.77	2.76	2.26	0.78	2.90	2.80	0.81	3.46	3.20	0.83	3.84	3.55	0.85	4.18	5.06	1.11	4.58		

Abbreviations:

LWT: Leaving water temperature (°C)

DB: Dry-bulb temperature for Outdoor air temperature (°C)

CC: Total cooling capacity (kW)

PI: Power input (kW)

Table 2-4.11: MDVA-V10WD2ER8-A cooling capacity

Maximum																								
DB	LWT																							
	5			7			10			11			15			18			20			25		
	CC	PI	EER	CC	PI	EER	CC	PI	EER	CC	PI	EER	CC	PI	EER	CC	PI	EER	CC	PI	EER	CC	PI	EER
-5	/	/	/	/	/	/	/	/	/	/	/	/	6.83	0.69	9.92	7.94	0.77	10.35	8.79	0.82	10.66	9.35	0.77	12.13
0	/	/	/	/	/	/	/	/	/	/	/	/	6.61	0.77	8.56	7.30	0.80	9.14	7.76	0.81	9.61	8.30	0.76	10.88
5	/	/	/	/	/	/	/	/	/	/	/	/	6.38	0.89	7.19	6.66	0.84	7.92	6.74	0.79	8.56	7.25	0.75	9.63
10	/	/	/	/	/	/	/	/	/	/	/	/	5.30	0.69	7.69	6.55	0.75	8.73	7.48	0.79	9.51	8.17	0.80	10.18
15	/	/	/	/	/	/	/	/	/	/	/	/	6.30	1.07	5.89	6.56	1.06	6.18	7.61	1.03	7.35	8.68	1.10	7.91
19	6.01	1.21	4.98	6.52	1.28	5.11	7.01	1.32	5.31	7.30	1.33	5.50	8.46	1.35	6.25	9.64	1.45	6.63	10.53	1.52	6.93	12.12	1.57	7.73
20	6.20	1.28	4.86	6.72	1.35	4.98	7.19	1.39	5.17	7.49	1.40	5.33	8.67	1.45	5.97	9.88	1.57	6.31	10.79	1.64	6.57	12.49	1.68	7.45
25	7.13	1.68	4.24	7.73	1.77	4.37	8.26	1.81	4.56	8.59	1.83	4.70	9.87	1.88	5.24	11.11	2.00	5.55	12.00	2.07	5.79	13.93	2.17	6.42
30	8.06	2.17	3.71	8.63	2.24	3.86	9.34	2.31	4.05	9.68	2.33	4.16	11.08	2.40	4.62	12.34	2.51	4.91	13.21	2.57	5.14	15.37	2.79	5.51
35	8.13	2.70	3.01	8.53	2.72	3.13	9.48	2.43	3.72	9.79	2.57	3.82	11.03	2.62	4.21	12.05	2.68	4.49	12.70	2.68	4.73	14.51	2.87	5.06
40	6.61	2.52	2.62	7.04	2.46	2.86	7.42	2.37	3.14	7.71	2.40	3.21	8.88	2.53	3.51	9.71	2.55	3.81	10.23	2.51	4.07	12.27	2.83	4.34
43	5.09	2.28	2.23	5.39	2.25	2.39	5.64	2.19	2.58	5.86	2.17	2.70	6.73	2.13	3.16	7.56	2.17	3.48	8.15	2.17	3.75	10.04	2.49	4.03
Normal																								
DB	LWT																							
	5			7			10			11			15			18			20			25		
	CC	PI	EER	CC	PI	EER	CC	PI	EER	CC	PI	EER	CC	PI	EER	CC	PI	EER	CC	PI	EER	CC	PI	EER
-5	/	/	/	/	/	/	/	/	/	/	/	/	5.50	0.49	11.21	6.40	0.54	11.83	7.15	0.58	12.31	7.59	0.55	13.82
0	/	/	/	/	/	/	/	/	/	/	/	/	5.33	0.54	9.79	5.90	0.56	10.53	6.33	0.57	11.14	6.75	0.53	12.66
5	/	/	/	/	/	/	/	/	/	/	/	/	5.11	0.65	7.84	5.32	0.61	8.74	5.41	0.57	9.54	5.88	0.56	10.60
10	/	/	/	/	/	/	/	/	/	/	/	/	4.29	0.52	8.22	5.26	0.55	9.53	5.99	0.57	10.51	6.58	0.58	11.37
15	/	/	/	/	/	/	/	/	/	/	/	/	4.73	0.76	6.24	5.06	0.77	6.55	6.39	0.82	7.80	7.36	0.86	8.54
19	4.67	0.89	5.23	5.18	0.95	5.43	5.60	0.98	5.69	5.89	1.00	5.89	7.06	1.05	6.70	8.16	1.14	7.15	9.06	1.21	7.51	10.48	1.23	8.51
20	4.83	0.95	5.11	5.36	1.01	5.31	5.82	1.05	5.55	6.10	1.07	5.72	7.23	1.13	6.42	8.35	1.23	6.80	9.29	1.31	7.10	10.87	1.32	8.21
25	5.65	1.26	4.49	6.25	1.34	4.68	6.78	1.38	4.91	7.10	1.41	5.04	8.35	1.50	5.58	9.53	1.59	5.99	10.47	1.66	6.32	12.30	1.71	7.18
30	6.48	1.64	3.95	7.17	1.74	4.12	7.78	1.80	4.32	8.12	1.83	4.45	9.51	1.92	4.95	10.73	2.04	5.26	11.69	2.12	5.51	13.76	2.26	6.08
35	6.31	2.01	3.15	8.20	2.52	3.25	8.57	2.16	3.96	8.68	2.13	4.07	9.09	2.05	4.43	9.90	2.18	4.55	11.08	2.18	5.09	13.23	2.39	5.54
40	5.40	1.92	2.81	5.87	1.90	3.08	6.27	1.86	3.38	6.56	1.90	3.46	7.73	2.04	3.79	8.56	2.06	4.15	9.18	2.06	4.47	11.14	2.28	4.89
43	4.18	1.80	2.32	4.33	1.74	2.49	4.44	1.66	2.67	4.62	1.65	2.80	5.36	1.61	3.32	6.24	1.68	3.71	6.98	1.72	4.06	7.94	1.80	4.41
Minimum																								
DB	LWT																							
	5			7			10			11			15			18			20			25		
	CC	PI	EER	CC	PI	EER	CC	PI	EER	CC	PI	EER	CC	PI	EER	CC	PI	EER	CC	PI	EER	CC	PI	EER
-5	/	/	/	/	/	/	/	/	/	/	/	/	3.56	0.30	11.68	4.11	0.34	12.24	4.61	0.36	12.69	4.93	0.34	14.49
0	/	/	/	/	/	/	/	/	/	/	/	/	3.46	0.34	10.23	3.80	0.35	10.96	4.09	0.35	11.61	4.39	0.33	13.14
5	/	/	/	/	/	/	/	/	/	/	/	/	2.75	0.33	8.42	2.86	0.31	9.32	2.93	0.29	10.13	3.17	0.28	11.40
10	/	/	/	/	/	/	/	/	/	/	/	/	2.38	0.26	9.04	2.92	0.28	10.33	3.31	0.29	11.30	3.67	0.30	12.22
15	/	/	/	/	/	/	2.90	0.44	6.62	3.00	0.43	6.96	3.42	0.41	8.33	3.77	0.41	9.28	4.08	0.40	10.14	5.11	0.47	10.81
19	2.39	0.44	5.45	2.45	0.43	5.65	2.62	0.44	5.96	2.80	0.45	6.19	3.56	0.50	7.11	4.26	0.56	7.60	4.91	0.61	8.02	5.96	0.65	9.11
20	2.44	0.46	5.31	2.50	0.45	5.52	2.55	0.44	5.79	2.75	0.46	5.99	3.59	0.53	6.81	4.38	0.61	7.18	5.11	0.68	7.49	6.17	0.71	8.68
25	2.71	0.59	4.60	2.77	0.57	4.85	2.81	0.55	5.15	3.04	0.57	5.30	3.95	0.67	5.88	4.76	0.76	6.28	5.52	0.83	6.64	6.69	0.89	7.54
30	3.08	0.76	4.03	3.15	0.74	4.26	3.19	0.70	4.53	3.44	0.74	4.66	4.45	0.86	5.19	5.31	0.96	5.53	6.10	1.05	5.82	7.41	1.18	6.30
35	2.88	0.85	3.37	3.26	0.87	3.76	3.61	0.86	4.19	3.80	0.88	4.32	4.55	0.94	4.86	5.26	1.01	5.21	5.90	1.07	5.52	7.28	1.23	5.93
40	2.44	0.87	2.80	2.70	0.86	3.12	2.94	0.84	3.48	3.11	0.87	3.57	3.79	0.97	3.93	4.38	1.02	4.30	4.91	1.06	4.64	6.34	1.28	4.97
43	1.43	0.60	2.37	1.78	0.70	2.55	2.12	0.77	2.76	2.26	0.78	2.90	2.80	0.81	3.46	3.20	0.83	3.84	3.55	0.85	4.18	5.06	1.11	4.58

Abbreviations:

LWT: Leaving water temperature (°C)

DB: Dry-bulb temperature for Outdoor air temperature (°C)

CC: Total cooling capacity (kW)

PI: Power input (kW)



Table 2-4.12: MDVA-V12WD2ER8-A cooling capacity

Maximum																										
DB	LWT																									
	5			7			10			11			15			18			20			25				
	CC	PI	EER	CC	PI	EER	CC	PI	EER	CC	PI	EER	CC	PI	EER	CC	PI	EER	CC	PI	EER	CC	PI	EER		
-5	/	/	/	/	/	/	/	/	/	/	/	/	/	9.55	1.27	7.50	10.05	1.34	7.48	10.39	1.41	7.37	11.39	1.36	8.35	
0	/	/	/	/	/	/	/	/	/	/	/	/	/	9.33	1.57	5.93	10.20	1.53	6.66	10.90	1.49	7.32	11.89	1.50	7.92	
5	/	/	/	/	/	/	/	/	/	/	/	/	/	9.12	1.71	5.32	10.35	1.63	6.33	11.41	1.57	7.27	12.38	1.64	7.57	
10	/	/	/	/	/	/	/	/	/	9.13	2.19	4.17	10.81	2.05	5.27	12.07	1.98	6.10	13.14	1.92	6.85	14.18	1.94	7.32		
15	/	/	/	/	/	/	1051	2.32	4.53	1091	2.32	4.69	12.50	2.33	5.36	13.79	2.30	6.00	14.87	2.27	6.56	15.98	2.24	7.14		
19	7.32	1.87	3.92	969	2.41	4.01	1182	2.83	4.19	1223	2.85	4.29	13.83	2.94	4.70	14.89	2.94	5.07	15.72	2.92	5.37	16.42	2.70	6.09		
20	7.78	2.03	3.83	1009	2.56	3.94	1215	2.96	4.10	1255	3.00	4.19	14.16	3.12	4.54	15.17	3.14	4.84	15.93	3.14	5.08	16.53	2.84	5.82		
25	10.10	3.00	3.37	1209	3.38	3.57	1380	3.61	3.82	1420	3.67	3.87	15.82	3.91	4.04	16.54	3.97	4.17	17.00	4.01	4.24	17.07	3.44	4.96		
30	9.99	3.58	2.79	1188	3.96	3.00	1343	4.13	3.25	1378	4.14	3.33	15.18	4.17	3.64	15.80	4.17	3.79	16.17	4.15	3.90	16.11	3.74	4.31		
35	9.89	4.33	2.29	1181	4.38	2.70	1307	4.72	2.77	1336	4.62	2.89	14.53	4.29	3.39	15.05	4.22	3.57	15.34	4.14	3.71	15.26	3.86	3.95		
40	8.11	4.53	1.79	9.10	4.50	2.02	9.87	4.33	2.28	10.03	4.24	2.37	10.67	3.92	2.72	11.52	4.00	2.88	12.19	4.05	3.01	13.23	3.77	3.51		
43	5.20	3.72	1.40	5.72	3.52	1.63	6.11	3.26	1.87	6.35	3.20	1.98	7.33	3.02	2.43	7.99	3.11	2.57	8.53	3.19	2.67	10.68	3.26	3.27		
Normal																										
DB	LWT																									
	5			7			10			11			15			18			20			25				
	CC	PI	EER	CC	PI	EER	CC	PI	EER	CC	PI	EER	CC	PI	EER	CC	PI	EER	CC	PI	EER	CC	PI	EER	CC	PI
-5	/	/	/	/	/	/	/	/	/	/	/	/	/	7.69	0.91	8.47	8.11	0.95	8.54	8.46	0.99	8.51	9.25	0.97	9.52	
0	/	/	/	/	/	/	/	/	/	/	/	/	/	7.53	1.11	6.78	8.25	1.07	7.68	8.89	1.05	8.48	9.67	1.05	9.22	
5	/	/	/	/	/	/	/	/	/	/	/	/	/	7.30	1.26	5.80	8.27	1.18	6.99	9.16	1.13	8.10	10.05	1.21	8.32	
10	/	/	/	/	/	/	/	/	/	7.36	1.66	4.43	8.68	1.51	5.75	9.68	1.44	6.74	10.57	1.38	7.65	11.54	1.43	8.07		
15	/	/	/	/	/	/	7.88	1.62	4.86	8.41	1.66	5.06	10.50	1.80	5.82	11.70	1.76	6.63	12.78	1.74	7.36	13.43	1.67	8.05		
19	5.68	1.38	4.12	7.67	1.78	4.30	9.44	2.08	4.54	9.86	2.11	4.67	11.54	2.24	5.16	12.60	2.25	5.59	13.53	2.27	5.96	14.20	2.07	6.86		
20	6.07	1.51	4.02	8.01	1.90	4.23	9.83	2.20	4.46	10.22	2.24	4.57	11.81	2.36	4.99	12.82	2.40	5.33	13.71	2.44	5.61	14.39	2.19	6.56		
25	8.00	2.24	3.56	9.74	2.53	3.85	11.33	2.71	4.17	11.74	2.78	4.22	13.39	3.04	4.41	14.19	3.09	4.60	14.84	3.14	4.73	15.07	2.65	5.68		
30	8.04	2.71	2.97	9.69	3.00	3.23	11.19	3.18	3.52	11.56	3.20	3.61	13.03	3.27	3.99	13.74	3.30	4.16	14.31	3.34	4.28	14.43	2.97	4.86		
35	8.98	3.75	2.40	11.50	4.18	2.75	12.13	4.25	2.85	12.10	4.02	3.01	11.97	3.28	3.65	12.00	3.04	3.95	13.39	3.38	3.96	13.91	3.18	4.37		
40	6.62	3.45	1.92	7.54	3.43	2.20	8.35	3.35	2.49	8.53	3.29	2.59	9.28	3.09	3.00	10.16	3.17	3.21	10.94	3.24	3.38	12.00	2.97	4.05		
43	4.27	2.93	1.45	4.57	2.68	1.70	4.80	2.44	1.97	5.01	2.39	2.10	5.83	2.23	2.61	6.60	2.36	2.80	7.30	2.47	2.96	8.44	2.30	3.66		
Minimum																										
DB	LWT																									
	5			7			10			11			15			18			20			25				
	CC	PI	EER	CC	PI	EER	CC	PI	EER	CC	PI	EER	CC	PI	EER	CC	PI	EER	CC	PI	EER	CC	PI	EER	CC	PI
-5	/	/	/	/	/	/	/	/	/	/	/	/	/	4.98	0.56	8.83	5.23	0.59	8.84	5.46	0.62	8.78	6.00	0.60	9.98	
0	/	/	/	/	/	/	/	/	/	/	/	/	/	4.88	0.69	7.09	5.33	0.67	8.00	5.75	0.65	8.84	6.29	0.66	9.56	
5	/	/	/	/	/	/	/	/	/	/	/	/	/	3.93	0.63	6.23	4.46	0.60	7.45	4.96	0.58	8.61	5.41	0.60	8.95	
10	/	/	/	/	/	/	/	/	/	4.07	0.83	4.89	4.81	0.77	6.24	5.37	0.74	7.25	5.91	0.72	8.20	6.40	0.73	8.75		
15	/	/	/	/	/	/	4.83	0.94	5.16	4.99	0.93	5.37	5.63	0.91	6.22	6.02	0.84	7.19	6.39	0.79	8.11	7.67	0.86	8.92		
19	2.91	0.68	4.29	3.58	0.80	4.47	4.41	0.93	4.75	4.69	0.96	4.90	5.82	1.06	5.47	6.58	1.11	5.94	7.32	1.15	6.35	8.07	1.10	7.33		
20	3.07	0.73	4.18	3.70	0.84	4.39	4.30	0.92	4.65	4.61	0.97	4.78	5.86	1.11	5.29	6.72	1.20	5.62	7.55	1.28	5.92	8.16	1.18	6.93		
25	3.84	1.05	3.65	4.28	1.07	3.99	4.69	1.07	4.38	5.02	1.13	4.43	6.33	1.36	4.64	7.09	1.47	4.82	7.82	1.58	4.96	8.19	1.38	5.95		
30	3.82	1.26	3.03	4.22	1.27	3.34	4.59	1.25	3.68	4.89	1.29	3.78	6.10	1.46	4.17	6.80	1.56	4.36	7.47	1.65	4.51	7.77	1.54	5.04		
35	3.50	1.42	2.46	4.26	1.50	2.83	4.98	1.64	3.04	5.18	1.61	3.21	5.99	1.53	3.90	6.57	1.56	4.21	7.13	1.64	4.36	7.66	1.65	4.65		
40	2.99	1.56	1.91	3.46	1.56	2.22	3.91	1.53	2.56	4.04	1.51	2.67	4.55	1.46	3.11	5.21	1.57	3.32	5.85	1.67	3.50	6.83	1.66	4.12		
43	1.46	0.98	1.48	1.89	1.08	1.75	2.30	1.13	2.03	2.45	1.13	2.17	3.05	1.12	2.72	3.39	1.17	2.89	3.72	1.22	3.04	5.38	1.42	3.80		

Abbreviations:

LWT: Leaving water temperature (°C)

DB: Dry-bulb temperature for Outdoor air temperature (°C)

CC: Total cooling capacity (kW)

PI: Power input (kW)

Table 2-4.13: MDVA-V14WD2ER8-A cooling capacity

Maximum																								
DB	LWT																							
	5			7			10			11			15			18			20			25		
	CC	PI	EER	CC	PI	EER	CC	PI	EER	CC	PI	EER	CC	PI	EER	CC	PI	EER	CC	PI	EER	CC	PI	EER
-5	/	/	/	/	/	/	/	/	/	/	/	/	10.03	1.32	7.57	10.55	1.40	7.55	10.91	1.47	7.44	11.96	1.42	8.43
0	/	/	/	/	/	/	/	/	/	/	/	/	9.80	1.67	5.87	10.71	1.62	6.59	11.45	1.58	7.24	12.48	1.59	7.84
5	/	/	/	/	/	/	/	/	/	/	/	/	9.57	1.76	5.44	10.86	1.68	6.47	11.98	1.61	7.43	13.00	1.68	7.73
10	/	/	/	/	/	/	/	/	/	/	/	/	10.02	2.46	4.07	11.35	2.18	5.21	12.34	2.03	6.07	13.14	1.92	6.85
15	/	/	/	/	/	/	/	/	/	/	/	/	10.98	2.32	4.60	11.40	2.39	4.77	13.06	2.32	5.45	14.41	2.36	6.10
19	7.69	1.99	3.86	10.37	2.63	3.95	12.40	2.99	4.15	12.83	3.02	4.25	14.51	3.11	4.67	15.30	3.02	5.06	15.85	2.94	5.40	16.50	2.70	6.11
20	8.17	2.17	3.77	10.80	2.78	3.88	12.76	3.16	4.04	13.18	3.20	4.12	14.87	3.33	4.47	15.52	3.23	4.80	15.93	3.14	5.08	16.53	2.84	5.82
25	10.61	3.19	3.32	12.95	3.67	3.53	14.49	3.84	3.77	14.91	3.91	3.82	16.62	4.16	3.99	16.94	4.09	4.14	17.00	4.01	4.24	17.07	3.44	4.96
30	10.49	3.96	2.65	12.79	4.47	2.86	14.10	4.53	3.11	14.47	4.54	3.19	15.94	4.56	3.49	16.18	4.37	3.70	16.17	4.18	3.87	16.11	3.74	4.31
35	10.38	4.81	2.16	12.84	5.45	2.35	13.72	5.32	2.58	14.03	5.22	2.69	15.26	4.88	3.13	15.42	4.66	3.31	15.34	4.44	3.45	15.26	4.12	3.71
40	8.11	4.53	1.79	9.28	4.59	2.02	9.87	4.33	2.28	10.03	4.24	2.37	10.67	3.92	2.72	11.52	4.00	2.88	12.19	4.05	3.01	13.23	3.77	3.51
43	5.20	3.72	1.40	5.83	3.59	1.63	6.11	3.26	1.87	6.35	3.20	1.98	7.33	3.02	2.43	7.99	3.11	2.57	8.53	3.19	2.67	10.68	3.26	3.27
Normal																								
DB	LWT																							
	5			7			10			11			15			18			20			25		
	CC	PI	EER	CC	PI	EER	CC	PI	EER	CC	PI	EER	CC	PI	EER	CC	PI	EER	CC	PI	EER	CC	PI	EER
-5	/	/	/	/	/	/	/	/	/	/	/	/	8.07	0.94	8.56	8.52	0.99	8.63	8.88	1.03	8.60	9.72	1.01	9.61
0	/	/	/	/	/	/	/	/	/	/	/	/	7.90	1.18	6.71	8.66	1.14	7.60	9.33	1.11	8.39	10.16	1.11	9.13
5	/	/	/	/	/	/	/	/	/	/	/	/	7.67	1.29	5.93	8.68	1.21	7.15	9.61	1.16	8.28	10.55	1.24	8.50
10	/	/	/	/	/	/	/	/	/	/	/	/	8.08	1.87	4.32	9.12	1.60	5.69	9.90	1.48	6.71	10.57	1.38	7.65
15	/	/	/	/	/	/	8.24	1.67	4.94	8.78	1.71	5.14	10.97	1.85	5.92	12.23	1.81	6.74	13.36	1.79	7.48	13.76	1.68	8.19
19	5.97	1.47	4.05	8.21	1.94	4.24	9.90	2.20	4.50	10.34	2.24	4.63	12.11	2.37	5.12	12.94	2.32	5.59	13.64	2.28	5.99	14.26	2.07	6.88
20	6.37	1.61	3.96	8.58	2.06	4.16	10.32	2.35	4.40	10.73	2.39	4.50	12.40	2.52	4.92	13.12	2.48	5.30	13.71	2.44	5.61	14.39	2.19	6.56
25	8.40	2.39	3.52	10.43	2.74	3.80	11.89	2.89	4.12	12.33	2.96	4.17	14.06	3.23	4.35	14.52	3.18	4.57	14.84	3.14	4.73	15.07	2.65	5.68
30	8.44	2.99	2.82	10.38	3.37	3.08	11.75	3.49	3.37	12.14	3.51	3.46	13.68	3.57	3.83	14.07	3.46	4.06	14.31	3.37	4.25	14.43	2.97	4.86
35	8.07	3.56	2.27	12.40	4.96	2.50	12.86	4.75	2.71	12.92	4.54	2.85	13.17	3.87	3.40	13.50	3.74	3.61	13.59	3.58	3.80	13.91	3.35	4.15
40	6.62	3.45	1.92	7.69	3.50	2.20	8.35	3.35	2.49	8.53	3.29	2.59	9.28	3.09	3.00	10.16	3.17	3.21	10.94	3.24	3.38	12.00	2.97	4.05
43	4.27	2.93	1.45	4.66	2.73	1.70	4.80	2.44	1.97	5.01	2.39	2.10	5.83	2.23	2.61	6.60	2.36	2.80	7.30	2.47	2.96	8.44	2.30	3.66
Minimum																								
DB	LWT																							
	5			7			10			11			15			18			20			25		
	CC	PI	EER	CC	PI	EER	CC	PI	EER	CC	PI	EER	CC	PI	EER	CC	PI	EER	CC	PI	EER	CC	PI	EER
-5	/	/	/	/	/	/	/	/	/	/	/	/	5.22	0.59	8.92	5.49	0.61	8.93	5.73	0.65	8.86	6.30	0.63	10.08
0	/	/	/	/	/	/	/	/	/	/	/	/	5.13	0.73	7.01	5.59	0.71	7.92	6.04	0.69	8.75	6.61	0.70	9.47
5	/	/	/	/	/	/	/	/	/	/	/	/	4.12	0.65	6.37	4.68	0.61	7.61	5.21	0.59	8.80	5.68	0.62	9.15
10	/	/	/	/	/	/	/	/	/	/	/	4.47	0.94	4.77	5.06	0.82	6.16	5.49	0.76	7.21	5.91	0.72	8.20	
15	/	/	/	/	/	/	5.05	0.96	5.24	5.22	0.96	5.46	5.88	0.93	6.32	6.29	0.86	7.31	6.68	0.81	8.25	7.86	0.87	9.07
19	3.06	0.72	4.22	3.79	0.86	4.40	4.62	0.98	4.71	4.92	1.01	4.86	6.10	1.12	5.43	6.75	1.14	5.93	7.38	1.16	6.38	8.10	1.10	7.36
20	3.22	0.78	4.12	3.92	0.91	4.32	4.52	0.99	4.58	4.85	1.03	4.71	6.16	1.18	5.21	6.87	1.23	5.58	7.55	1.28	5.92	8.16	1.18	6.93
25	4.03	1.12	3.60	4.53	1.15	3.94	4.93	1.14	4.32	5.27	1.21	4.37	6.65	1.45	4.58	7.25	1.51	4.79	7.82	1.58	4.96	8.19	1.38	5.95
30	4.01	1.39	2.88	4.47	1.40	3.18	4.82	1.37	3.53	5.14	1.42	3.62	6.41	1.60	4.01	6.95	1.63	4.26	7.47	1.67	4.48	7.77	1.54	5.04
35	3.67	1.58	2.33	4.50	1.68	2.68	5.23	1.78	2.94	5.44	1.76	3.09	6.29	1.70	3.69	6.72	1.60	4.21	7.13	1.73	4.11	7.66	1.73	4.44
40	2.99	1.56	1.91	3.49	1.57	2.22	3.91	1.53	2.56	4.04	1.51	2.67	4.55	1.46	3.11	5.21	1.57	3.32	5.85	1.67	3.50	6.83	1.66	4.12
43	1.46	0.98	1.48	1.90	1.09	1.75	2.30	1.13	2.03	2.45	1.13	2.17	3.05	1.12	2.72	3.39	1.17	2.89	3.72	1.22	3.04	5.38	1.42	3.80

Abbreviations:

LWT: Leaving water temperature (°C)

DB: Dry-bulb temperature for Outdoor air temperature (°C)

CC: Total cooling capacity (kW)

PI: Power input (kW)

Table 2-4.14: MDVA-V16WD2ER8-A cooling capacity

Maximum																										
DB	LWT																									
	5			7			10			11			15			18			20			25				
	CC	PI	EER	CC	PI	EER	CC	PI	EER	CC	PI	EER	CC	PI	EER	CC	PI	EER	CC	PI	EER	CC	PI	EER		
-5	/	/	/	/	/	/	/	/	/	/	/	/	10.03	1.32	7.57	10.55	1.40	7.55	10.91	1.47	7.44	11.96	1.42	8.43		
0	/	/	/	/	/	/	/	/	/	/	/	/	9.80	1.67	5.87	10.71	1.62	6.59	11.45	1.58	7.24	12.48	1.59	7.84		
5	/	/	/	/	/	/	/	/	/	/	/	/	9.57	1.76	5.44	10.86	1.68	6.47	11.98	1.61	7.43	13.00	1.68	7.73		
10	/	/	/	/	/	/	/	/	/	/	/	10.02	2.46	4.07	11.35	2.18	5.21	12.34	2.03	6.07	13.14	1.92	6.85	14.18	1.94	7.32
15	/	/	/	/	/	/	1137	2.43	4.67	1180	2.44	4.84	13.52	2.44	5.53	14.92	2.41	6.19	16.08	2.37	6.77	16.96	2.30	7.37		
19	8.46	2.23	3.78	1141	2.94	3.87	1350	3.29	4.10	1386	3.29	4.21	15.31	3.30	4.65	16.15	3.20	5.04	16.73	3.11	5.38	17.41	2.86	6.08		
20	8.99	2.43	3.70	1188	3.12	3.80	1404	3.55	3.96	1438	3.55	4.05	15.76	3.56	4.42	16.46	3.46	4.75	16.89	3.36	5.03	17.52	3.04	5.76		
25	1167	3.59	3.25	1424	4.13	3.45	1594	4.32	3.69	1624	4.36	3.73	17.45	4.47	3.90	17.72	4.38	4.04	17.85	4.31	4.14	17.92	3.70	4.84		
30	1154	4.46	2.59	1426	5.10	2.79	1551	5.11	3.04	1585	5.09	3.11	17.21	5.05	3.41	17.24	4.84	3.57	17.14	4.66	3.68	16.92	4.02	4.21		
35	1142	5.42	2.11	1418	6.17	2.30	1509	6.00	2.52	1537	5.91	2.60	16.48	5.60	2.94	16.50	5.28	3.13	16.26	4.96	3.27	16.17	4.47	3.62		
40	8.92	5.11	1.75	1021	5.18	1.97	1086	4.89	2.22	1103	4.78	2.31	11.73	4.42	2.65	12.67	4.57	2.77	13.41	4.69	2.86	14.55	4.36	3.34		
43	5.98	4.50	1.33	6.87	4.44	1.54	7.33	4.12	1.78	7.67	4.07	1.89	9.01	3.91	2.31	9.83	4.03	2.44	10.49	4.13	2.54	11.96	3.85	3.11		
Normal																										
DB	LWT																									
	5			7			10			11			15			18			20			25				
	CC	PI	EER	CC	PI	EER	CC	PI	EER	CC	PI	EER	CC	PI	EER	CC	PI	EER	CC	PI	EER	CC	PI	EER		
-5	/	/	/	/	/	/	/	/	/	/	/	/	8.07	0.94	8.56	8.52	0.99	8.63	8.88	1.03	8.60	9.72	1.01	9.61		
0	/	/	/	/	/	/	/	/	/	/	/	/	7.90	1.18	6.71	8.66	1.14	7.60	9.33	1.11	8.39	10.16	1.11	9.13		
5	/	/	/	/	/	/	/	/	/	/	/	/	7.67	1.29	5.93	8.68	1.21	7.15	9.61	1.16	8.28	10.55	1.24	8.50		
10	/	/	/	/	/	/	/	/	/	/	/	8.08	1.87	4.32	9.12	1.60	5.69	9.90	1.48	6.71	10.57	1.38	7.65	11.54	1.43	8.07
15	/	/	/	/	/	/	8.52	1.70	5.02	9.09	1.74	5.22	11.36	1.89	6.01	12.65	1.85	6.84	13.83	1.82	7.59	14.24	1.71	8.31		
19	6.56	1.65	3.98	9.03	2.17	4.15	1079	2.42	4.45	1118	2.44	4.58	12.78	2.51	5.10	13.66	2.45	5.56	14.39	2.41	5.96	15.05	2.20	6.85		
20	7.01	1.80	3.88	9.44	2.31	4.08	1135	2.63	4.31	1171	2.65	4.42	13.14	2.70	4.87	13.91	2.65	5.24	14.53	2.62	5.56	15.25	2.35	6.49		
25	9.24	2.69	3.43	1147	3.09	3.71	1308	3.25	4.02	1342	3.30	4.07	14.76	3.47	4.25	15.25	3.42	4.46	15.58	3.37	4.62	15.83	2.85	5.55		
30	9.28	3.37	2.75	1142	3.79	3.01	1293	3.93	3.29	1330	3.94	3.38	14.77	3.95	3.74	15.05	3.85	3.91	15.17	3.75	4.04	15.15	3.19	4.75		
35	9.87	4.46	2.21	1400	5.60	2.50	1419	5.23	2.71	1427	5.10	2.79	14.57	4.65	3.13	14.20	3.94	3.61	15.19	4.33	3.51	15.15	3.93	3.85		
40	7.28	3.89	1.87	8.46	3.95	2.14	9.18	3.78	2.43	9.39	3.71	2.53	10.21	3.49	2.93	11.18	3.62	3.09	12.03	3.75	3.21	13.20	3.43	3.84		
43	4.91	3.55	1.38	5.48	3.39	1.62	5.76	3.08	1.87	6.04	3.03	1.99	7.17	2.89	2.48	8.12	3.05	2.66	8.98	3.20	2.81	9.46	2.72	3.48		
Minimum																										
DB	LWT																									
	5			7			10			11			15			18			20			25				
	CC	PI	EER	CC	PI	EER	CC	PI	EER	CC	PI	EER	CC	PI	EER	CC	PI	EER	CC	PI	EER	CC	PI	EER		
-5	/	/	/	/	/	/	/	/	/	/	/	/	5.22	0.59	8.92	5.49	0.61	8.93	5.73	0.65	8.86	6.30	0.63	10.08		
0	/	/	/	/	/	/	/	/	/	/	/	/	5.13	0.73	7.01	5.59	0.71	7.92	6.04	0.69	8.75	6.61	0.70	9.47		
5	/	/	/	/	/	/	/	/	/	/	/	/	4.12	0.65	6.37	4.68	0.61	7.61	5.21	0.59	8.80	5.68	0.62	9.15		
10	/	/	/	/	/	/	/	/	/	/	/	4.47	0.94	4.77	5.06	0.82	6.16	5.49	0.76	7.21	5.91	0.72	8.20	6.40	0.73	8.75
15	/	/	/	/	/	/	5.23	0.98	5.32	5.40	0.97	5.54	6.08	0.95	6.41	6.51	0.88	7.42	6.91	0.83	8.37	8.14	0.88	9.21		
19	3.36	0.81	4.14	4.17	0.97	4.32	5.02	1.08	4.66	5.30	1.10	4.81	6.44	1.19	5.41	7.13	1.21	5.91	7.79	1.22	6.36	8.55	1.17	7.33		
20	3.54	0.88	4.04	4.31	1.02	4.24	4.97	1.11	4.49	5.28	1.14	4.62	6.53	1.27	5.15	7.28	1.32	5.53	8.01	1.37	5.86	8.65	1.26	6.86		
25	4.43	1.26	3.52	4.98	1.30	3.85	5.42	1.28	4.22	5.73	1.34	4.27	6.98	1.56	4.47	7.61	1.63	4.68	8.21	1.69	4.85	8.60	1.48	5.81		
30	4.41	1.57	2.81	4.92	1.58	3.11	5.31	1.54	3.44	5.63	1.59	3.54	6.92	1.77	3.91	7.43	1.81	4.10	7.92	1.86	4.26	8.15	1.66	4.92		
35	4.04	1.78	2.27	4.95	1.94	2.56	5.75	2.00	2.87	5.96	1.99	2.99	6.79	1.96	3.47	7.19	1.80	4.00	7.56	1.83	4.12	8.12	1.87	4.33		
40	3.29	1.76	1.86	3.84	1.77	2.17	4.30	1.72	2.50	4.44	1.70	2.60	5.01	1.65	3.03	5.73	1.80	3.19	6.43	1.93	3.33	7.52	1.92	3.91		
43	1.68	1.19	1.41	2.24	1.35	1.66	2.76	1.43	1.93	2.95	1.44	2.06	3.75	1.45	2.58	4.17	1.52	2.75	4.57	1.58	2.89	6.03	1.67	3.61		

Abbreviations:

LWT: Leaving water temperature (°C)

DB: Dry-bulb temperature for Outdoor air temperature (°C)

CC: Total cooling capacity (kW)

PI: Power input (kW)

## 5 Operating Limits

Figure 2-5.1: Heating operating limits<sup>1</sup>

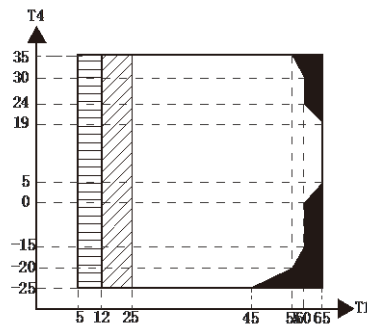

Figure 2-4.2: Cooling operating limits

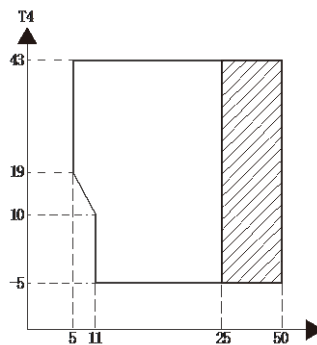
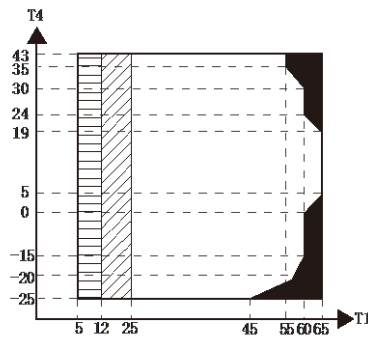

Figure 2-5.3: Domestic hot water operating limits<sup>1</sup>



Abbreviations:

T4: Outdoor temperature (°C)

T1: Leaving water temperature (°C)

Notes:

1. If IBH/AHS setting is valid, only IBH/AHS turns on; If IBH/AHS setting is invalid, only heat pump turns on
2. Water flow temperature drop or rise interval
3. IBH/AHS only

## 6 Hydronic Performance

Figure 2-6.1: MDVHB-60(100)CEGR8-A hydronic performance

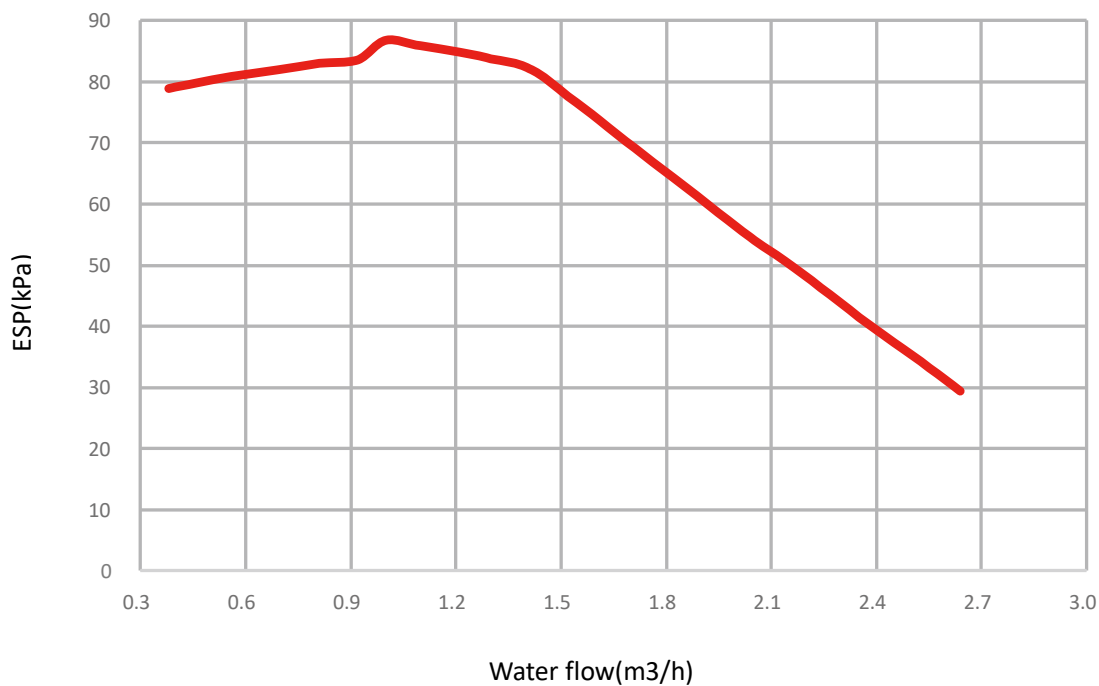
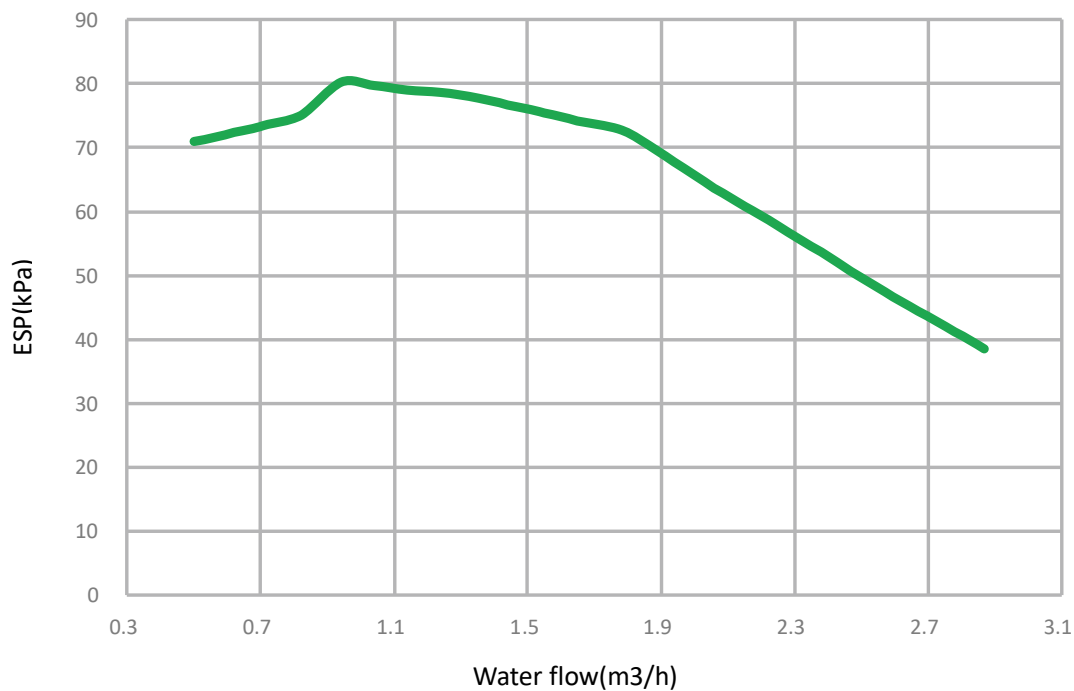

Figure 2-6.2: MDVHB-160CEGR8-A hydronic performance



## 7 Sound Levels

### 7.1 Overall

Table 2-7.1: Sound pressure levels<sup>1</sup>

Model name	dB
MDVA-V4WD2ER8-A	44
MDVA-V6WD2ER8-A	45
MDVA-V8WD2ER8-A	46
MDVA-V10WD2ER8-A	49
MDVA-V12WD2BR8-A	50
MDVA-V14WD2BR8-A	51
MDVA-V16WD2BR8-A	55
MDVA-V12WD2BR8-A	50
MDVA-V14WD2BR8-A	51
MDVA-V16WD2BR8-A	55

Notes:

1. Sound pressure level is measured at a position 1m in front of the unit and  $(1+H)/2$ m (where H is the height of the unit) above the floor in a semi-anechoic chamber. During in-situ operation, sound pressure levels may be higher as a result of ambient noise. Sound pressure level is the maximum value tested under the two conditions of Notes2 and Notes3. For 16kW model, the value is calculated and it is for reference only

Figure 2-6.1: Sound pressure level measurement (unit: mm)

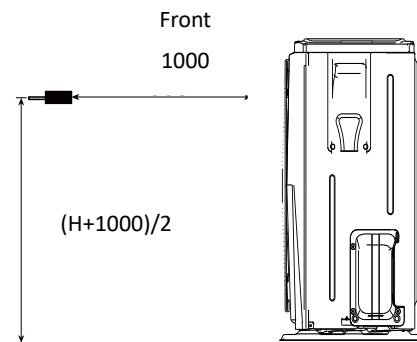

2. Outdoor air temperature 7°C DB, 85% R.H.; EWT 30°C, LWT 35°C.
3. Outdoor air temperature 35°C DB; EWT 23°C, LWT 18°C..

7.2 Octave Band Levels

Figure 2-7.2: MDVA-V4WD2ER8-A octave band levels

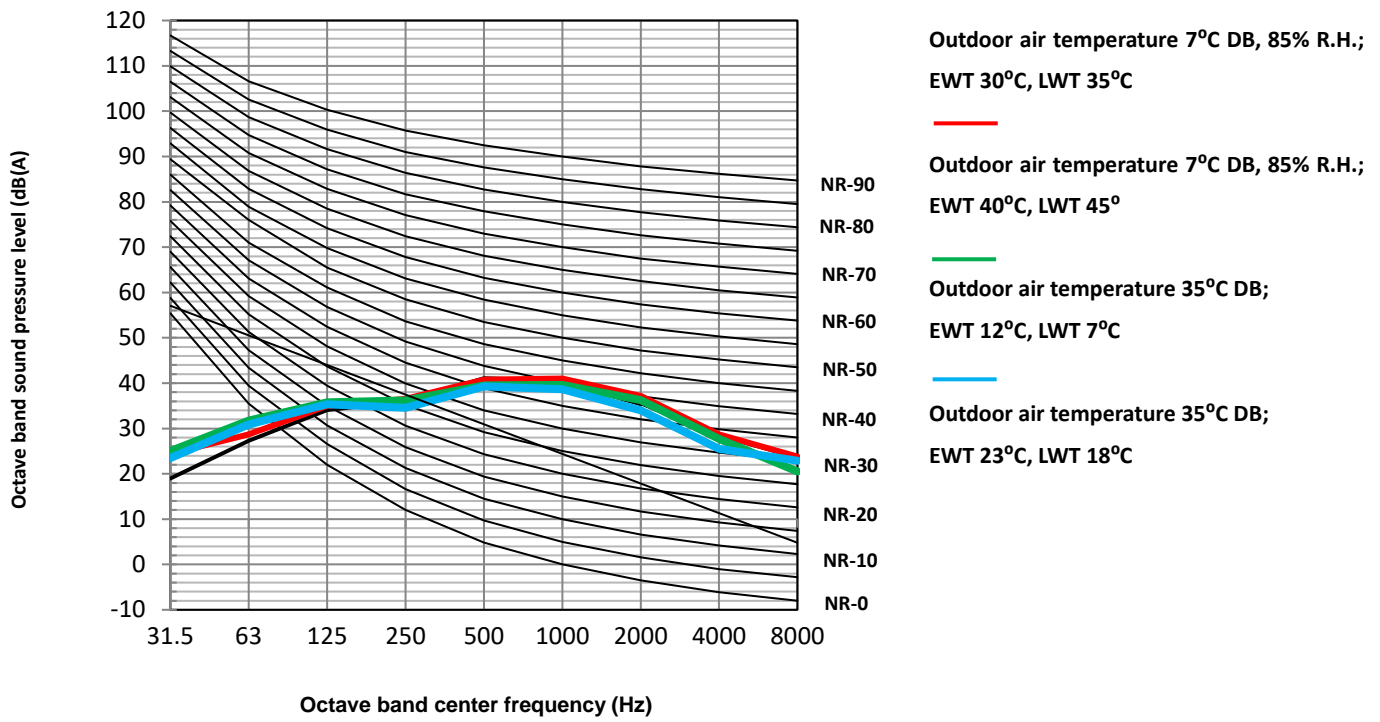

Figure 2-7.3: MDVA-V6WD2ER8-A octave band levels

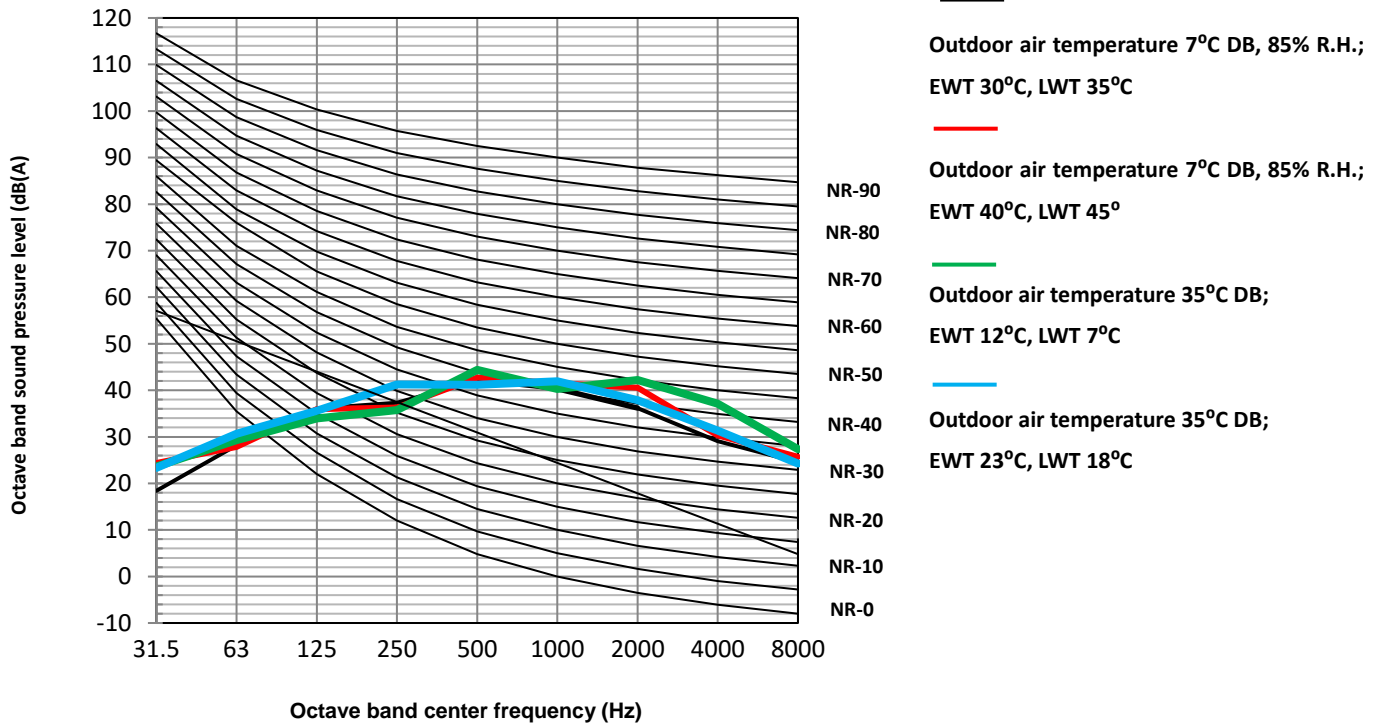

Figure 2-7.4: MDVA-V8WD2ER8-A octave band levels

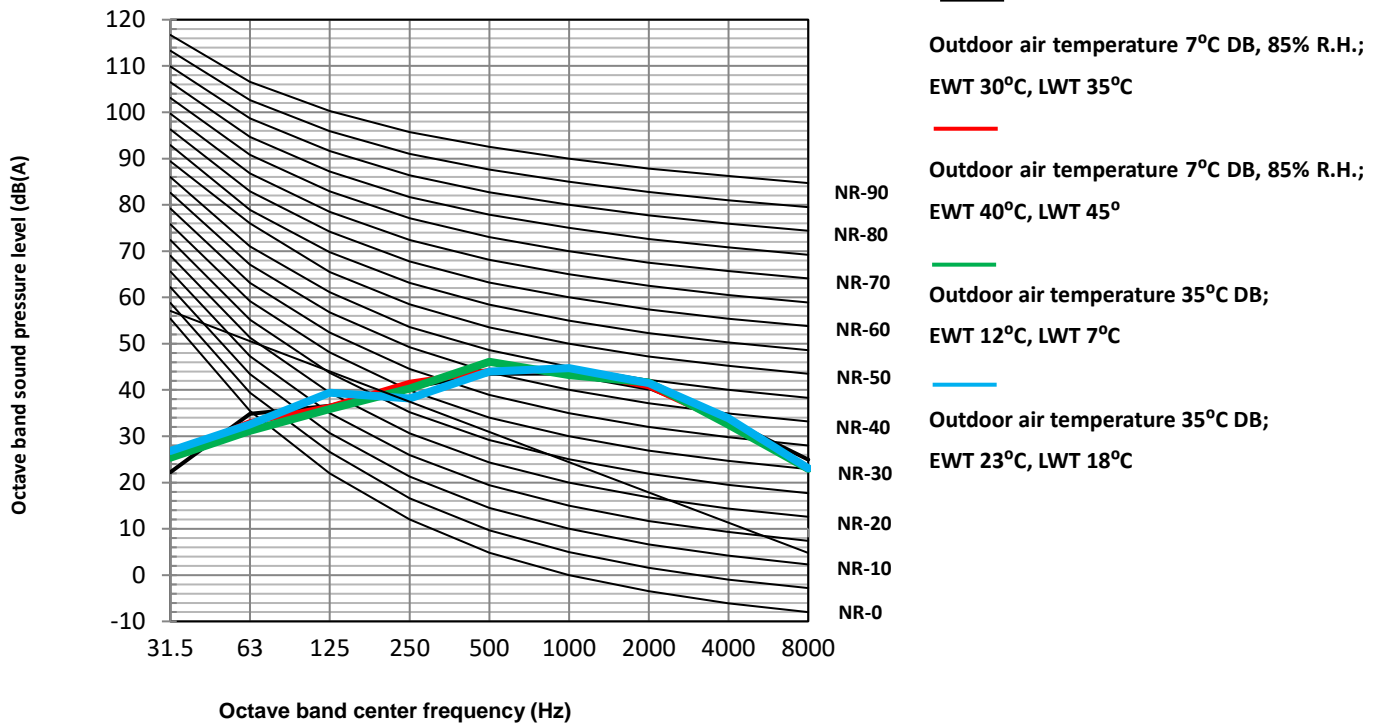

Figure 2-7.5: MDVA-V10WD2ER8-A octave band levels

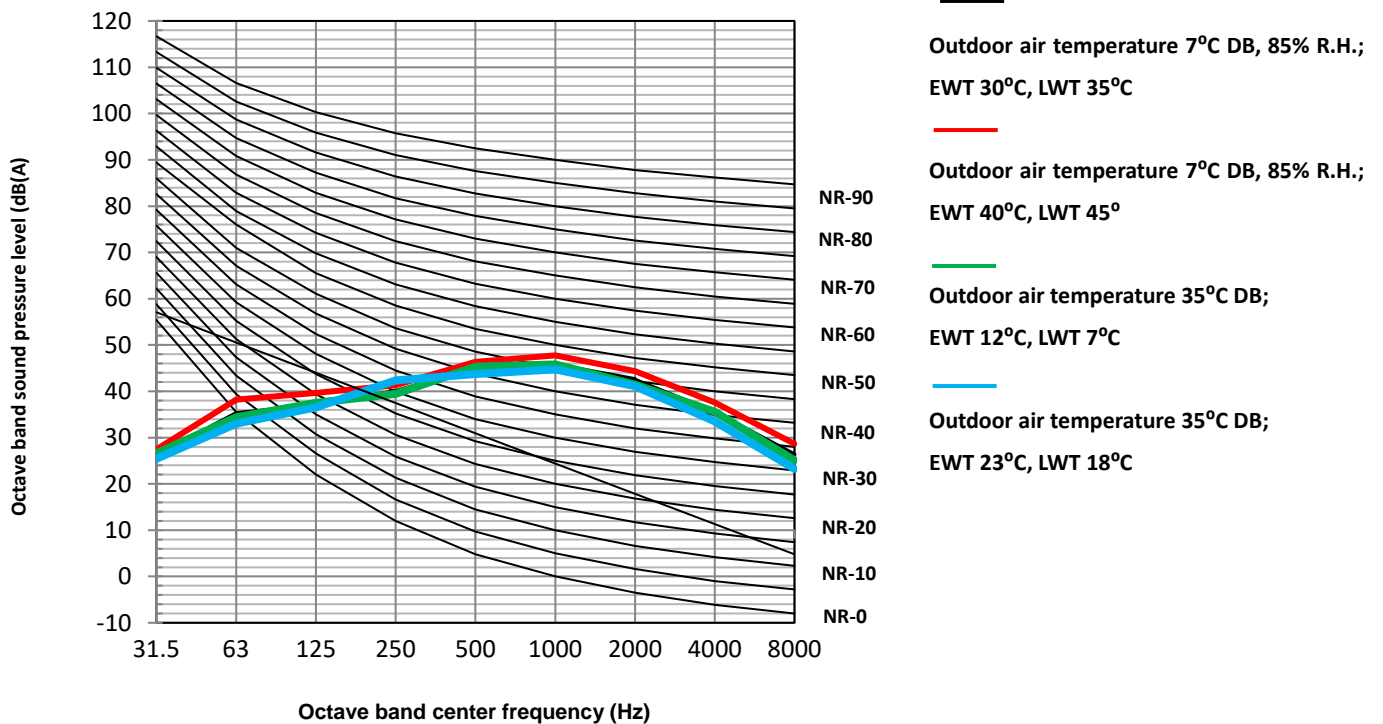



Figure 2-7.5: MDVA-V12WD2ER8-A octave band levels

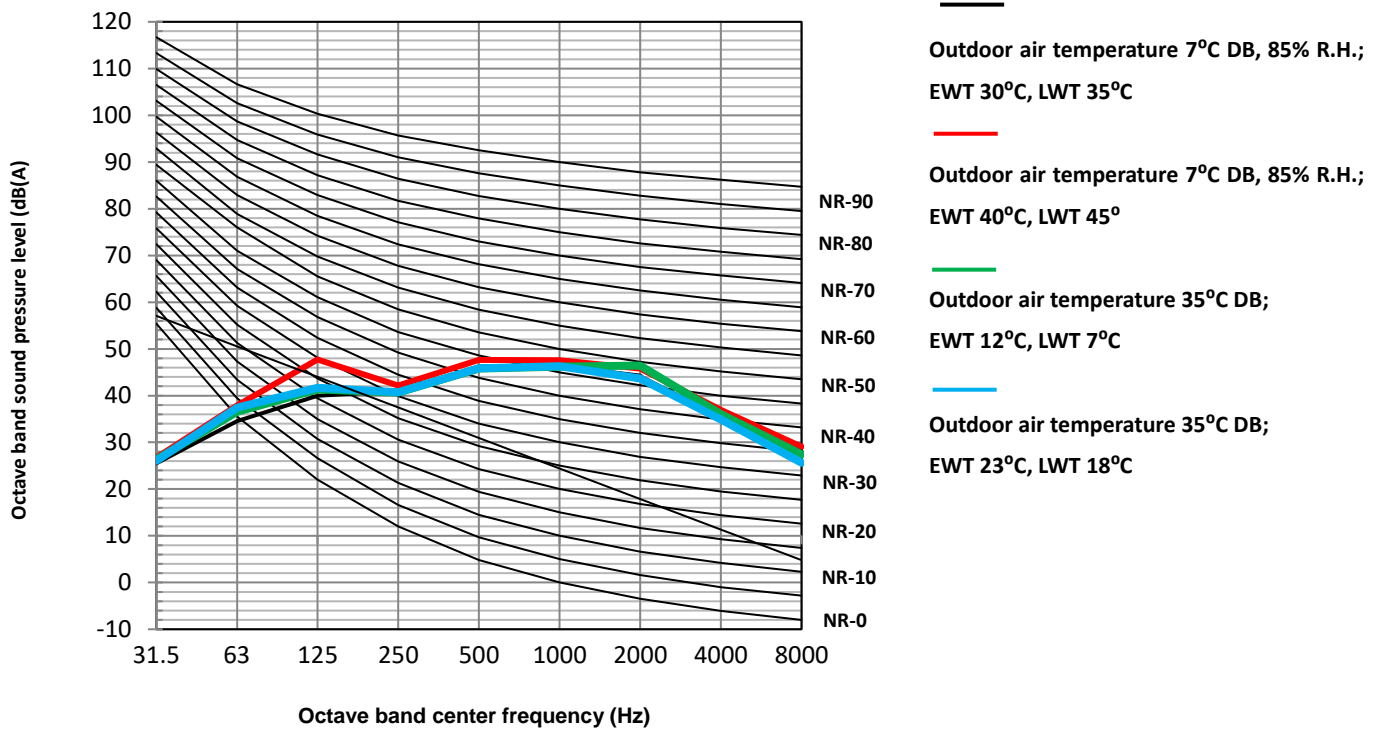

Figure 2-7.5: MDVA-V14WD2ER8-A octave band levels

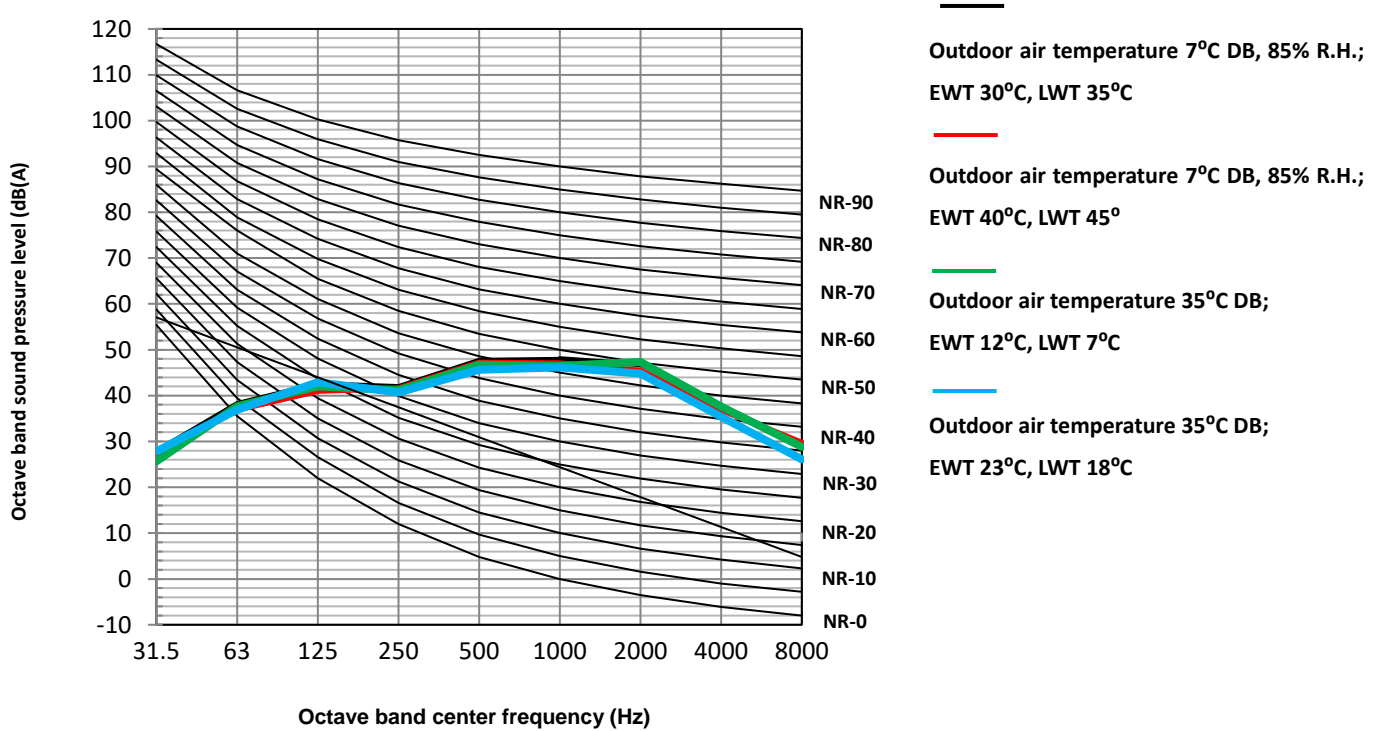

Figure 2-7.5: MDVA-V12WD2BR8-A octave band levels

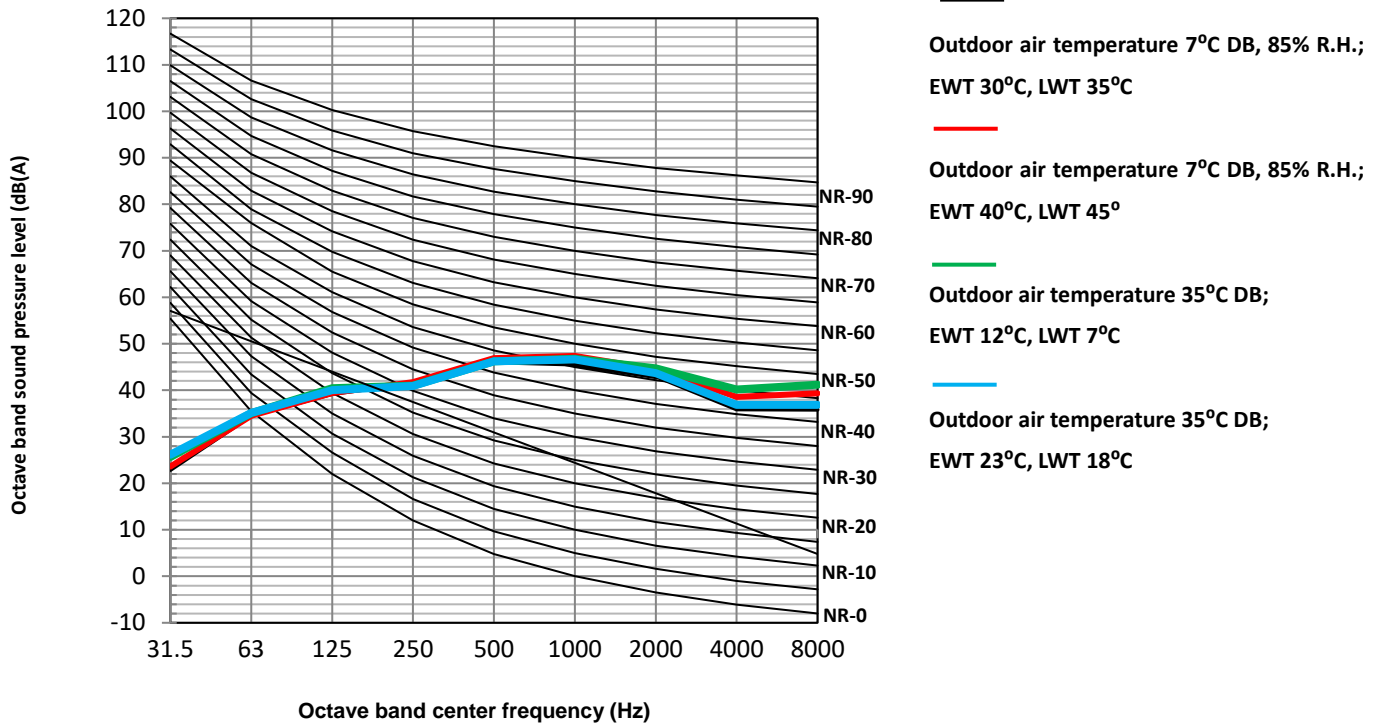
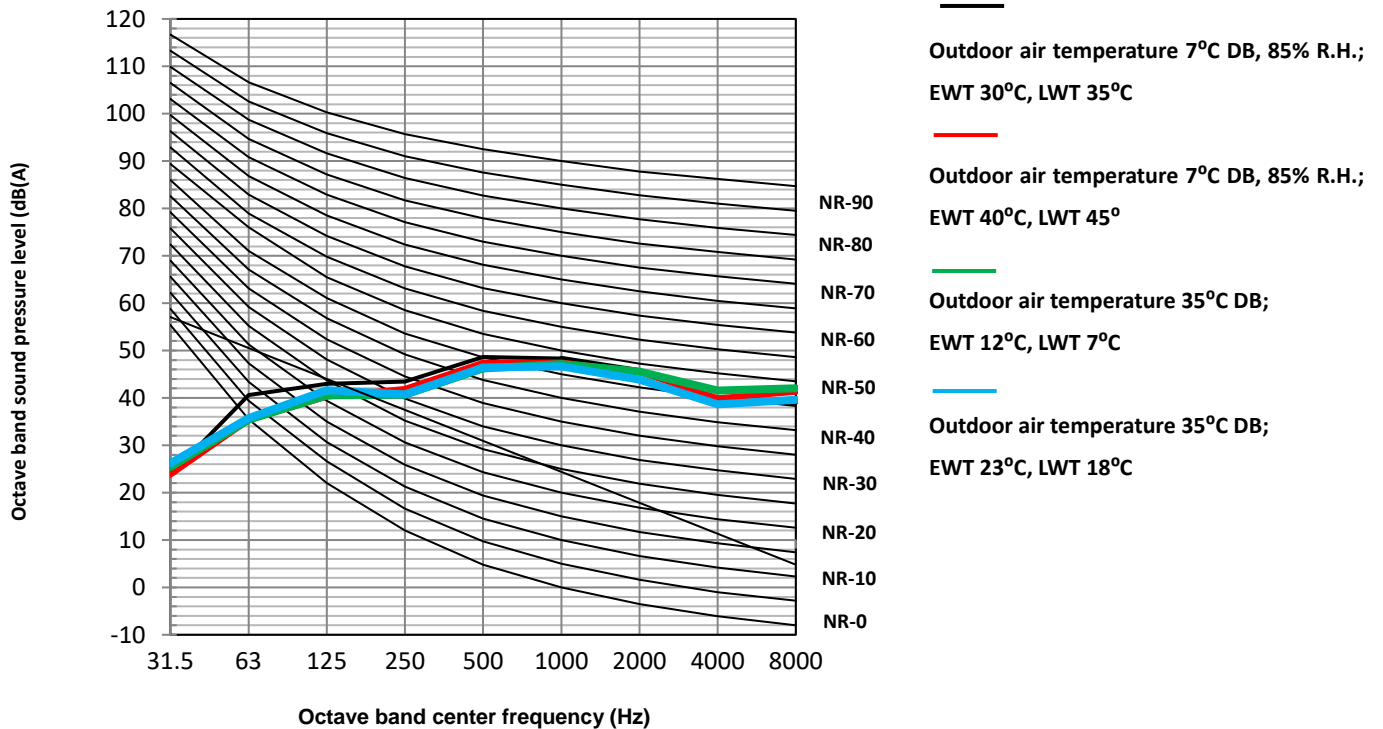





Figure 2-7.5: MDVA-V14WD2BR8-A octave band levels



## 8 Accessories











### 8.1 Outdoor Unit

Table 2-8.1: Outdoor unit accessories

Name	Shape	Quantity
Outdoor unit installation and owner's manual		1
Technical data manual		1
Water outlet connection pipe assembly		1
Energy lable		1

### 8.2 Hydronic Box

Table 2-8.2: Hydronic box accessories

Name	Shape	Quantity		
		MDVHB-60CEGR8-A	MDVHB-100CEGR8-A	MDVHB-160CEGR8-A
Indoor unit installation and owner's manual		1	1	1
Operation manual		1	1	1
M16 Copper Nut Tamper Cap		1	1	1
M9 Copper Nut Tamper Cap		0	1	1
M6 Copper Nut Tamper Cap		1	0	0
M8 expansion screws		5	5	5
Temperature sensor for domestic hot water tank or zone 2 water flow		1	1	1
M16 Copper nut		1	1	1
Y-shaped filter		1	1	1
Mounting bracket		1	1	1
Operation manual(Wired controller)		1	1	1

# Part 3

# Installation and Field Settings

<b>1 Preface to Part 3 .....</b>	<b>70</b>
<b>2 Installation .....</b>	<b>71</b>
<b>3 Refrigerant Pipework .....</b>	<b>79</b>
<b>4 Water Pipework .....</b>	<b>92</b>
<b>5 Electrical Wiring .....</b>	<b>95</b>
<b>6 DIP Switch Settings .....</b>	<b>98</b>
<b>7 Internal Circulation Pump .....</b>	<b>98</b>
<b>8 User Interface Field Settings .....</b>	<b>99</b>
<b>9 Operation parameter .....</b>	<b>118</b>
<b>10 Network Configuration Guidelines .....</b>	<b>119</b>
<b>11 USB Function Guidelines.....</b>	<b>125</b>
<b>12 Climate Related Curves .....</b>	<b>127</b>
<b>13 Error Code Table.....</b>	<b>130</b>

## 1 Preface to Part 3

### 1.1 Notes for Installers Boxes

The information contained in this Engineering Data Book may primarily be of use during the system design stage of a MDV thermal Split project. Additional important information which may primarily be of use during field installation has been placed in boxes, such as the example below, titled “Notes for installers”.

#### Notes for installers



- Notes for installers boxes contain important information which may primarily be of use during field installation, rather than during desk-based system design.

### 1.2 Definitions

In this Engineering Data Book, the term “applicable legislation” refers to all national, local and other laws, standards, codes, rules, regulations and other legislation that apply in a given situation.

### 1.3 Precautions

All system installation including installation of refrigerant piping, water piping and electrical works must only be carried out by competent and suitably qualified, certified and accredited professionals and in accordance with all applicable legislation.

## 2 Installation

### 2.1 Acceptance and Unpacking

#### Notes for installers



- When units are delivered check whether any damage occurred during shipment. If there is damage to the surface or outside of a unit, submit a written report to the shipping company.
- Check that the model, specifications and quantity of the units delivered are as ordered.
- Check that all accessories ordered have been included. Retain the Owner's Manual for future reference.

### 2.2 Hoisting

#### Notes for installers



- Do not remove any packaging before hoisting. If units are not packaged or if the packaging is damaged, use suitable boards or packing material to protect the units.
- Hoist one unit at a time, using two ropes to ensure stability.
- Keep units upright during hoisting the outdoor unit, ensuring that the angle to the vertical does not exceed 30°.

## 2.3 Outdoor unit

### 2.3.1 Placement Considerations

Placement of the outdoor unit should take account of the following considerations:

- Outdoor units should not be exposed to direct radiation from a high-temperature heat source.
- Outdoor units should not be installed in positions where dust or dirt may affect heat exchangers.
- Outdoor units should not be installed in locations where exposure to oil or to corrosive or harmful gases, such as acidic or alkaline gases, may occur.
- Outdoor units should not be installed in locations where exposure to salinity may occur.
- Outdoor units should be installed in well-drained, well-ventilated positions.
- Outdoor units should be installed in locations where the noise from the unit will not disturb neighbors.

### 2.3.2 Strong Wind Installation

Wind of 5m/s or more blowing against an outdoor unit's air outlet blocks the flow of air through the unit, leading to deterioration in unit capacity, accelerated frost accumulation when in heating mode or domestic hot water mode, and potential disruption to operation due to increased pressure in the refrigerant circuit. Exposure to very strong wind can also cause the fan to rotate excessively fast, potentially leading to damage to the fan. In locations where exposure to high winds may occur should take account of the following considerations:

- For installation of the outdoor unit in a place where the wind direction can be foreseen. Set the outlet side at a right angle to the direction of the wind, refer to Figure 3-2.1.
- If turn the air outlet side toward the building's wall, fence or screen. Make sure there is enough room to do the installation

Figure 3-2.1: Strong wind installation direction

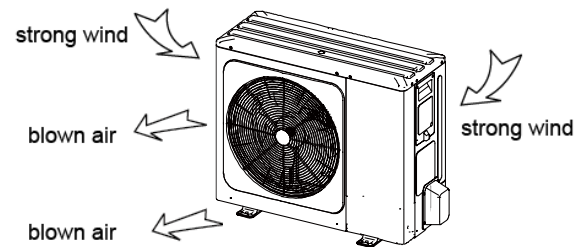

### 2.3.3 Cold Climate Installation

In cold climate locations installation should take account of the following considerations:

- Never install the unit at a site where the suction side may be exposed directly to wind.
- To prevent exposure to wind, install a baffle plate on the air discharge side of the unit.
- To prevent exposure to wind, install the unit with its suction side facing the wall.
- In areas of heavy snowfall, a canopy should be installed to prevent snow entering the unit. Additionally, the height of the base structure should be increased so as to raise the unit further off the ground. Refer to Figure 3-2.2.

1. Construct a large canopy
2. Construct a pedestal

Install the unit high enough off the ground to prevent it from being buried in snow.

Figure 3-2.2: Snow shielding

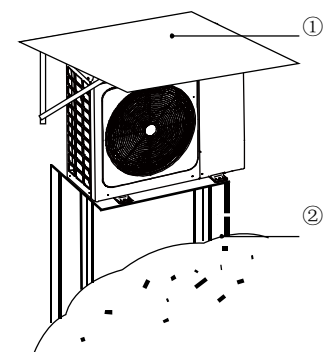

### 2.3.4 Hot Climate Installation

As the outdoor temperature is measured via the outdoor unit air thermistor, make sure to install the outdoor unit in the shade or a canopy should be constructed to avoid direct sunlight, so that it is not influenced by the sun's heat, otherwise protection may be possible to the unit.

### 2.3.5 Base Structure

Outdoor unit base structure design should take account of the following considerations:

- A solid base prevents excess vibration and noise. Outdoor unit bases should be constructed on solid ground or on structures of sufficient strength to support the unit's weight.
- Bases should be at least 100mm high to provide sufficient drainage and to prevent water ingress into the base of the

unit.

- Either steel or concrete bases may be suitable.
- Outdoor units should not be installed on supporting structures that could be damaged by water build-in in the event of a blocked drain.
- Fix the unit securely to foundation by means of the  $\Phi 10$  expansion bolt. It is best to screw in the foundation bolts until their length is 20 mm from the foundation surface.

Figure 3-2.3: Outdoor unit fixing

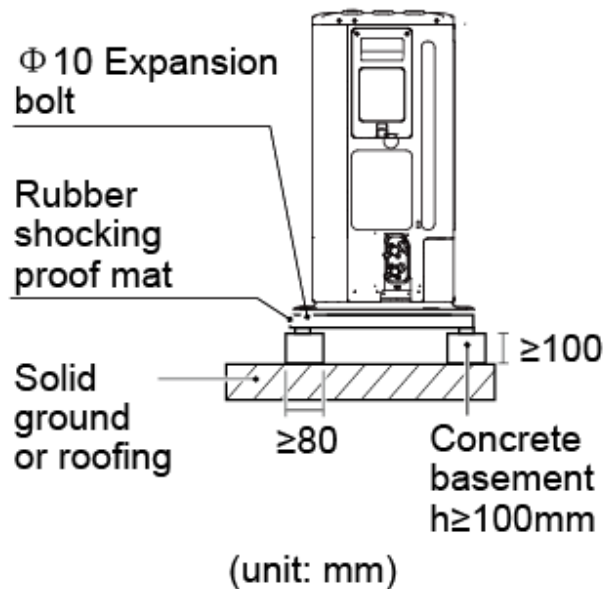

### 2.3.6 Drainage

Drainage ditch should be provided to allow drainage of condensate that may form on the air side heat exchanger when the unit is running in heating mode or domestic hot water mode. The drainage should ensure that condensate is directed away from roadways and footpaths, especially in locations where the climate is such that condensate may freeze.

Figure 3-2.4: 4-6kW models drainage hole

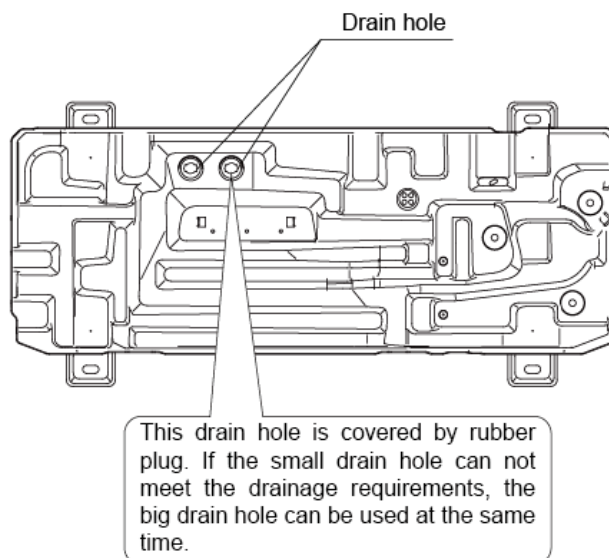
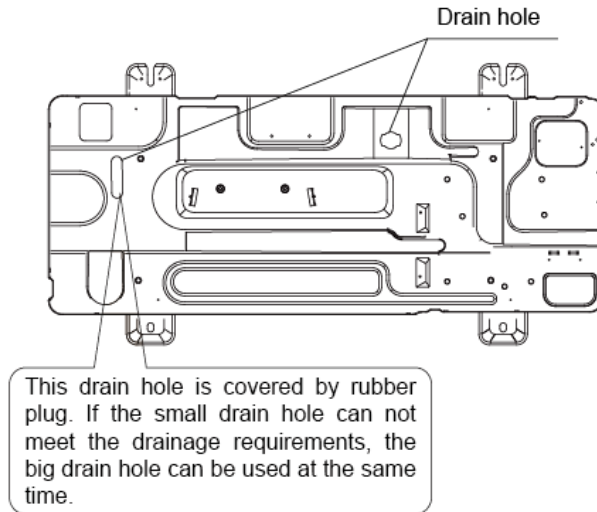



Figure 3-2.5: 8-16kW models drainage hole



**2.3.7 Transportation support**

For 12/14/16kW model, there is a transportation support which is used to protect tubes from breaking during transportation and this support should be taken off before turning on the heat pump.

Figure 3-2.6: 12-16kW models 2.3.7 transportation support

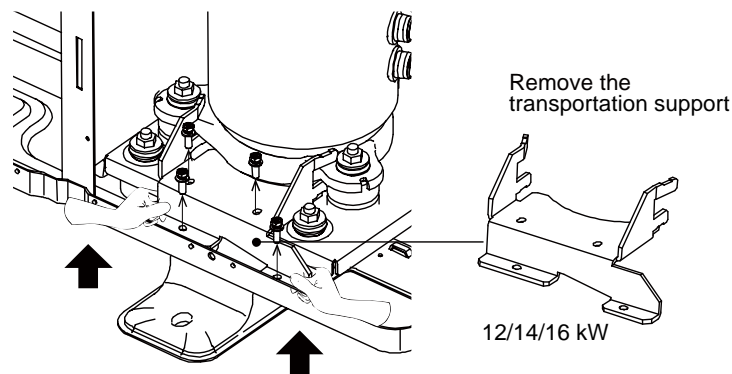

**2.3.8 Spacing**

**Single unit installation**

Outdoor unit must be spaced such that sufficient air may flow through each unit. Sufficient airflow across heat exchangers is essential for outdoor units to function properly.

Figure 3-2.7: Single unit installation requirement (Unit: mm)

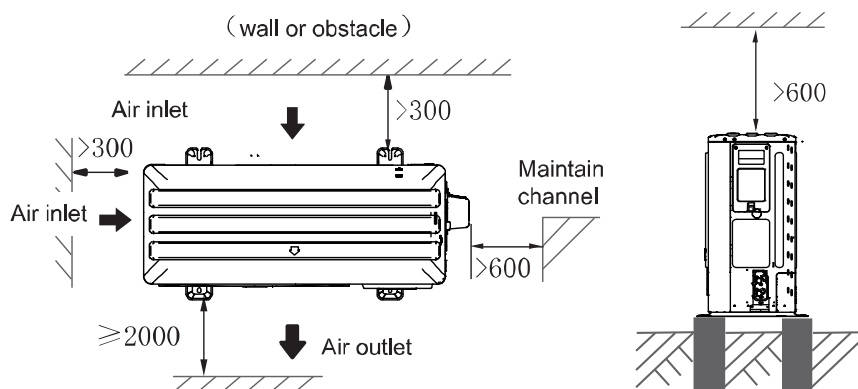

## Stacked installation

Figure 3-2.8: Installation with obstacles in front of the unit

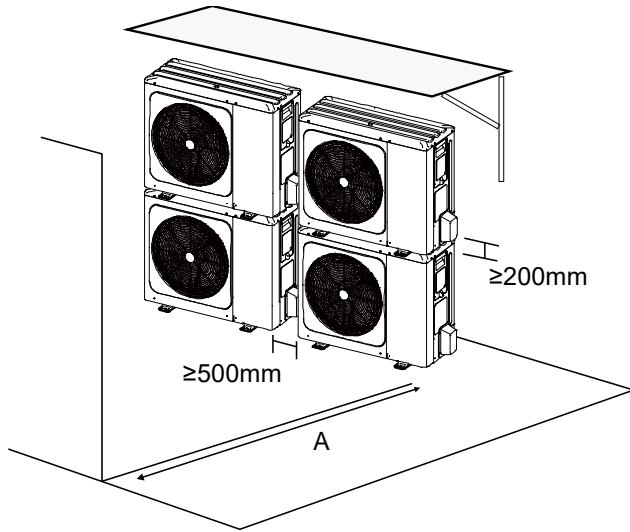
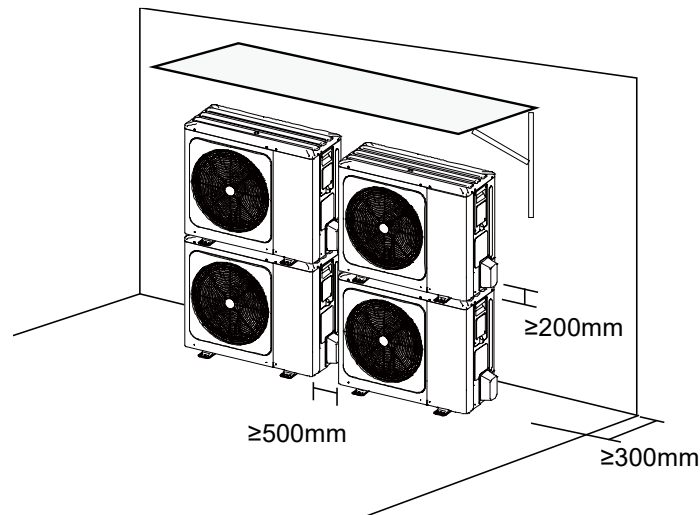

Table 3-2.1: Minimum spacing from obstacles in front of the unit

Model name	A (mm)
MDVA-V4WD2ER8-A	2000
MDVA-V6WD2ER8-A	
MDVA-V8WD2ER8-A	
MDVA-V10WD2ER8-A	
MDVA-V12WD2ER8-A	
MDVA-V14WD2ER8-A	
MDVA-V16WD2ER8-A	
MDVA-V12WD2BR8-A	
MDVA-V14WD2BR8-A	
MDVA-V16WD2BR8-A	

Figure 3-2.9: Installation with obstacles behind the unit



## Installation in Rows

Figure 3-2.10: Single row installation

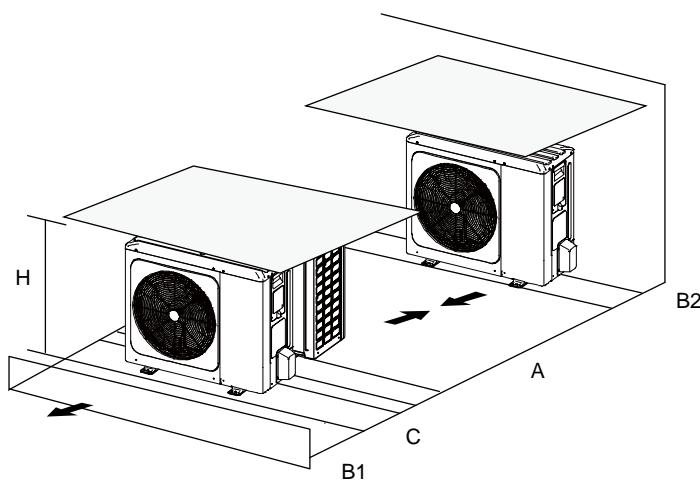

Single row installation spacing requirements				
Model name	A (mm)	B1 (mm)	B2 (mm)	C (mm)
MDVA-V4W/D2N8	≥3000	≥2000	≥150	≥600
MDVA-V6W/D2N8				
MDVA-V8W/D2N8				
MDVA-V10W/D2N8				
MDVA-V12WD2ER8-A				
MDVA-V14WD2ER8-A				
MDVA-V16WD2ER8-A				
MDVA-V12WD2BR8-A				
MDVA-V14WD2BR8-A				
MDVA-V16WD2BR8-A				

Figure 3-2.11: Multi-row installation

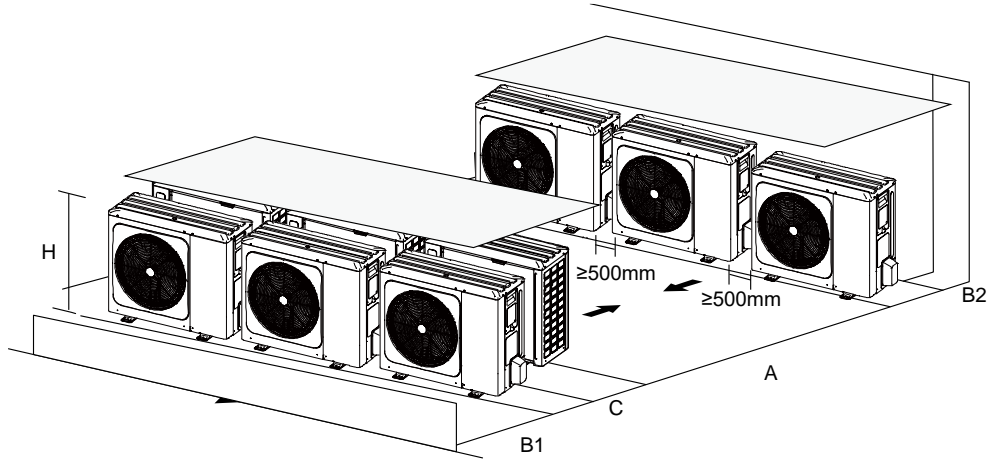

Table 3-2.3: Multiple row installation spacing requirements

Model name	A (mm)	B1 (mm)	B2 (mm)	C (mm)
MDVA-V4WD2ER8-A	≥3000	≥2000	≥300	≥600
MDVA-V6WD2ER8-A				
MDVA-V8WD2ER8-A				
MDVA-V10WD2ER8-A				
MDVA-V12WD2ER8-A				
MDVA-V14WD2ER8-A				
MDVA-V16WD2ER8-A				
MDVA-V12WD2BR8-A				
MDVA-V14WD2BR8-A				
MDVA-V16WD2BR8-A				

## 2.4 Hydronic box

### 2.4.1 Placement Considerations

- Hydronic box should be installed in positions that are as close as possible to the heat emitters.
- Hydronic box should be installed in positions that are sufficiently close to the desired position of the wired controller that the controller's wiring length limitation will not be exceeded.
- In systems that are configured to heat domestic hot water, hydronic box should be installed in positions that are sufficiently close to the domestic hot water tank that the temperature sensor wiring length limitations will not be exceeded.

### 2.4.2 Mounting the hydronic box

- Fix the wall mounting bracket to the wall using appropriate plugs and screws.

Figure 3-2.12: Wall bracket

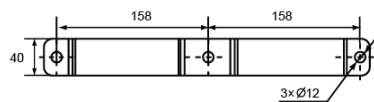
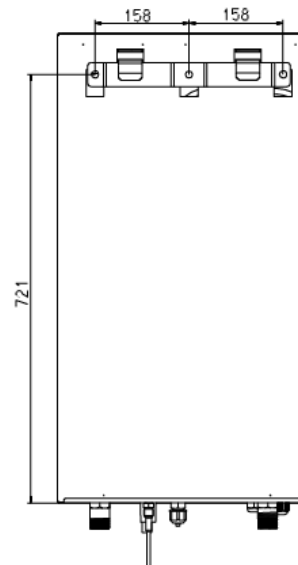
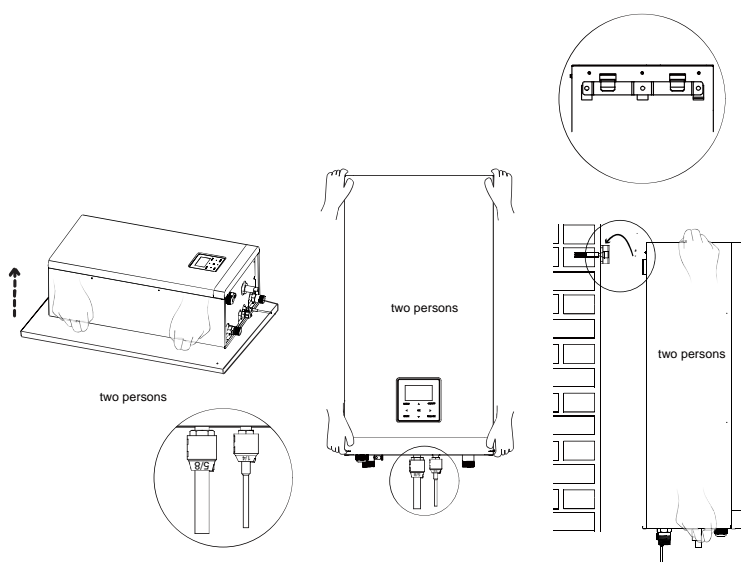

Figure 3-2.13: Hydronic box backside



- Make sure the wall mounting bracket is completely level. When the unit is not installed level, air might get trapped in the water circuit resulting in malfunctioning of the unit. Pay special attention to this when installing the hydronic box to prevent overflow of the drain pan.
- Hang the hydronic box on the wall mounting bracket.
- Fix the hydronic box at the bottom inside using appropriate plugs and screws. The hydronic box is equipped with 2 holes at the bottom outer edges of the frame.

Figure 3-2.14: Fix hydronic box



## 2.4.3 Service space requirement

The service space requirements refer to Figure 3-2.15.

Figure 3-2.15: Service space requirement (unit: mm)

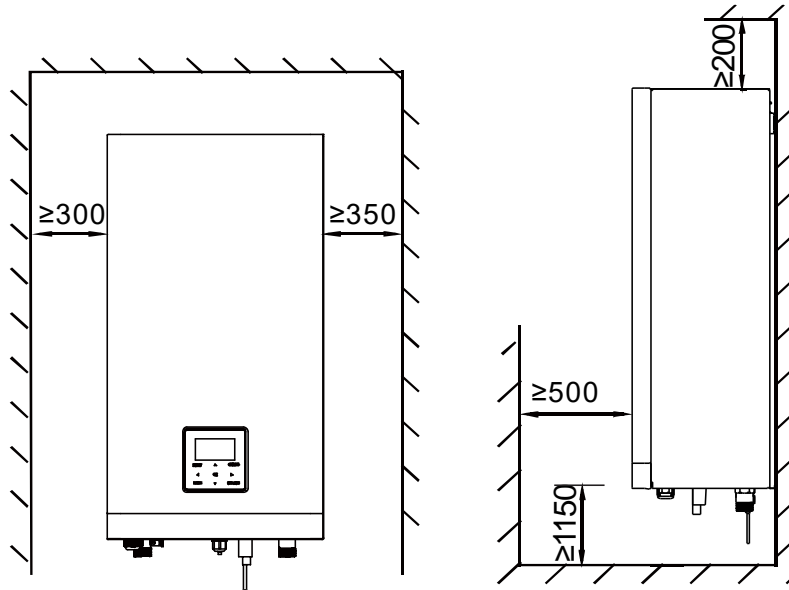

## 2.4.4 Drainage

The drainage connections of hydronic box refer to Figure 3-2.16.

Figure 3-2.16: Drainage

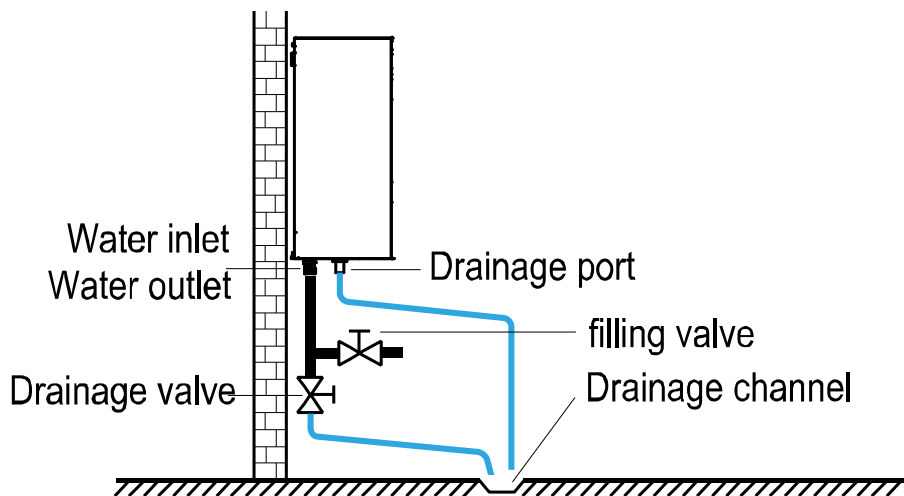

### 3 Refrigerant Pipework

#### 3.1 Permitted Piping Length and Level Difference

The piping length and level difference limitations that apply are summarized in Table 3-3.1. Before installation, it is necessary to check if the piping length and height difference are meeting the requirements.

Table 3-3.1: Permitted Piping Length and Level Difference

Models	4-16kW
Max. piping length	30m
Max. difference in height	20m

Figure 3-3.1: Connect method

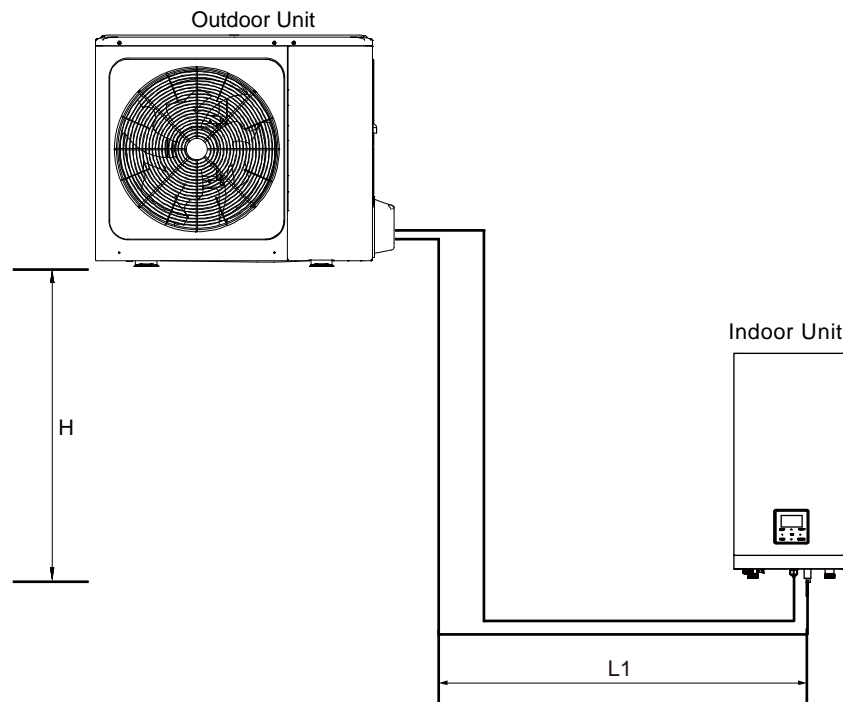

#### 3.2 Pipe Size and Connect method

Table 3-3.2: Refrigerant pipe connection

Models	4/6kW	8/10kW	12/14/16kW
Pipe connect			
Pipe size	Gas side (Φ15.9); Liquid side (Φ6.35);	Gas side (Φ15.9); Liquid side (Φ9.52);	Gas side (Φ15.9); Liquid side (Φ9.52);
Connect method	Flare	Flare	Flare

3.3 Procedure and Principles

3.3.1 Installation procedure

**Notes for installers**

Installation of the refrigerant piping system should proceed in the following order:

```

    graph LR
      A[Pipe insulation] --> B[Pipe brazing and installation]
      B --> C[Pipe flushing]
      C --> D[Gas tightness test]
      D --> E[Joint insulation]
      E --> F[Vacuum drying]
    
```

Note: Pipe flushing should be performed once the brazed connections have been completed with the exception of the final connections to the indoor units. That is, flushing should be performed once the outdoor units have been connected but before the indoor units are connected.

3.3.2 Three principles for refrigerant piping

	Reasons	Measures
CLEAN	Particles such as oxide produced during brazing and/or building dust can lead to compressor malfunction	<ul style="list-style-type: none"> <li>Seal piping during storage<sup>1</sup></li> <li>Flow nitrogen during brazing<sup>2</sup></li> <li>Pipe flushing<sup>3</sup></li> </ul>
DRY	Moisture can lead to ice formation or oxidization of internal components leading to abnormal operation or compressor damage	<ul style="list-style-type: none"> <li>Pipe flushing<sup>3</sup></li> <li>Vacuum drying<sup>4</sup></li> </ul>
SEALED	Imperfect seals can lead to refrigerant leakage	<ul style="list-style-type: none"> <li>Pipe manipulation<sup>5</sup> and brazing<sup>2</sup> techniques</li> <li>Gastightness test<sup>6</sup></li> </ul>

Notes:

1. See Part 3, 3.4.1 "Pipe delivery, storage and sealing".
2. See Part 3, 3.7 "Brazing".
3. See Part 3, 3.8 "Pipe Flushing".
4. See Part 3, 3.10 "Vacuum Drying".
5. See Part 3, 0 "Manipulating Copper Piping".
6. See Part 3, 3.9 "Gas tightness Test".

### 3.4 Storing Copper Piping

#### 3.4.1 Pipe delivery, storage and sealing

##### Notes for installers



- Ensure that piping does not get bent or deformed during delivery or whilst stored.
- On construction sites store piping in a designated location.
- To prevent dust or moisture entering, piping should be kept sealed whilst in storage and until it is about to be connected. If piping is to be used soon, seal the openings with plugs or adhesive tape. If piping is to be stored for a long time, charge the piping with nitrogen at 0.2-0.5MPa and seal the openings by brazing.
- Storing piping directly on the ground risks dust or water ingress. Wooden supports can be used to raise piping off the ground.
- During installation, ensure that piping to be inserted through a hole in a wall is sealed to ensure dust and/or fragments of wall do not enter.
- Be sure to seal piping being installed outdoors (especially if being installed vertically) to prevent rain entering.

### 3.5 Manipulating Copper Piping

#### 3.5.1 De-oiling

##### Notes for installers



- Lubrication oil used during some copper pipe manufacturing processes can cause deposits to form in R32 refrigerant systems, causing system errors. Oil-free copper piping should therefore be selected. If ordinary (oily) copper piping is used, it must be cleaned with gauze dipped in tetrachloroethylene solution prior to installation.

##### Caution

- Never use carbon tetrachloride (CCl<sub>4</sub>) for pipe cleansing or flushing, as doing so will seriously damage the system.

#### 3.5.2 Cutting copper piping and removing burrs

##### Notes for installers



- Use a pipe cutter rather than a saw or cutting machine to cut piping. Rotate the piping evenly and slowly, applying even force to ensure that the piping does not become deformed during cutting. Using a saw or cutting machine to cut piping runs the risk of copper shavings entering the piping. Copper shavings are difficult to remove and pose a serious risk to the system if they enter the compressor or block the throttling unit.
- After cutting using a pipe cutter, use a reamer/scrapper to remove any burrs that have formed at the opening, keeping the opening of the piping downwards to avoid copper shavings from entering the piping.
- Remove burrs carefully to avoid scratches, which may prevent a proper seal being formed and lead to refrigerant leakage.



3.5.3 Expanding copper piping ends

Notes for installers



- Ends of copper piping can be expanded so that another length of piping can be inserted and the joint brazed.
- Insert the expanding head of the pipe expander into the pipe. After completing pipe expansion, rotate the copper pipe a few degrees to rectify the straight line mark left by the expanding head.

Caution

- Ensure that the expanded section of piping is smooth and even. Remove any burrs that remain after cutting.

Figure 3-3.2: Expanding copper piping ends

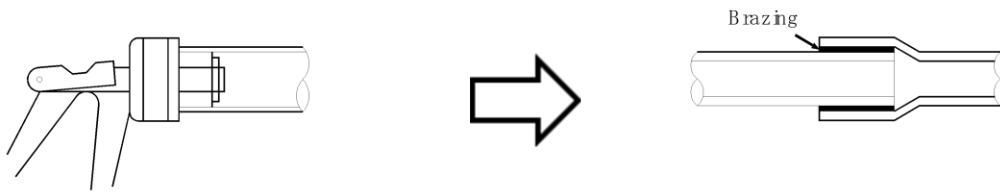

3.5.4 Flared joints

Flared joints should be used where a screw thread connection is required.

Notes for installers



- Before flaring 1/2H (half hard) piping, anneal the end of the pipe to be flared.
- Remember to place the flare nut on the piping before flaring.
- Ensure the flared opening is not cracked, deformed or scratched, otherwise it will not form a good seal and refrigerant leakage may occur.
- The diameter of the flared opening should be within the ranges specified in Table 3-3.3. Refer to Figure 3-3.3.

Table 3-3.3: Flared opening size ranges

Pipe (mm)	Flared opening diameter (A) (mm)
Φ6.35	8.7 - 9.1
Φ9.53	12.8 - 13.2
Φ12.7	16.2 - 16.6
Φ15.9	19.3 - 19.7
Φ19.1	23.6 - 24.0

Figure 3-3.3: Flared opening

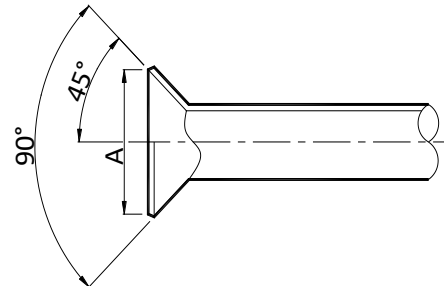

- When connecting a flared joint, apply some compressor oil to the inner and outer surfaces of the flared opening to facilitate the connection and rotation of the flare nut, ensure firm connection between the sealing surface and the bearing surface, and avoid the pipe becoming deformed.

## 3.5.5 Bending piping

Bending copper piping reduces the number of brazed joints required and can improve quality and save material.

### Notes for installers



#### Piping bending methods

- Hand bending is suitable for thin copper piping ( $\Phi 6.35\text{mm} - \Phi 12.7\text{mm}$ ).
- Mechanical bending (using a bending spring, manual bending machine or powered bending machine) is suitable for a wide range of diameters ( $\Phi 6.35\text{mm} - \Phi 54.0\text{mm}$ ).

#### Caution

- When using a spring bender, ensure that the bender is clean before inserting it in the piping.
- After bending a copper pipe, ensure that there are no wrinkles or deformation on either side of the pipe.
- Ensure that bend angles do not exceed  $90^\circ$ , otherwise wrinkles may appear on the inner side of the pipe, and the pipe may buckle or crack. Refer to Figure 3-3.4.
- Do not use a pipe that has buckled during the bending process; ensure that the cross section at the bend is greater than  $2/3$  of the original area.

Figure 3-3.4: Pipe bending in excess of  $90^\circ$

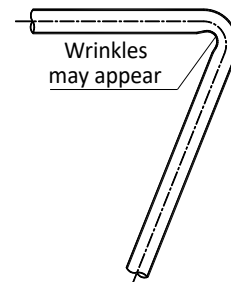

## 3.6 Refrigerant Piping Supports

When the air conditioning is running, the refrigerant piping will deform (shrink, expand and droop). To avoid damage to piping, hangers or supports should be spaced as per the criteria in the Table 3-3.4. In general, the gas and liquid pipes should be suspended in parallel and the interval between support points should be selected according to the diameter of the gas pipe.

Table 3-3.4: Refrigerant piping support spacings

Pipe (mm)	Interval between support points (m)	
	Horizontal Piping	Vertical Piping
< $\Phi 20$	1	1.5
$\Phi 20 - \Phi 40$	1.5	2
> $\Phi 40$	2	2.5

Suitable insulation should be provided between the piping and the supports. If wooden dowels or blocks are to be used, use wood that has undergone preservative treatment.

Changes in refrigerant flow direction and refrigerant temperature result in movement, expansion and shrinkage of the refrigerant piping. Piping should therefore not be fixed too tightly, otherwise stress concentrations may occur in the piping, with the potential for rupturing.

3.7 Brazing

Care must be taken to prevent oxide forming on the inside of copper piping during brazing. The presence of oxide in a refrigerant system adversely affects the operation of valves and compressors, potentially leading to low efficiency or even compressor failure. To prevent oxidation, during brazing nitrogen should be flowed through the refrigerant piping.

Notes for installers



Warning

- Never flow oxygen through piping as doing so aids oxidation and could easily lead to explosion and as such is extremely dangerous.
- Take appropriate safety precautions such as having a fire extinguisher to hand whilst brazing.

Flowing nitrogen during brazing

- Use a pressure reducing valve to flow nitrogen through copper piping at 0.02-0.03MPa during brazing.
- Start the flow before brazing starts and ensure that the nitrogen continuously passes through the section being brazed until the brazing is complete and the copper has cooled down completely.

Figure 3-3.5: Flowing nitrogen through piping during brazing

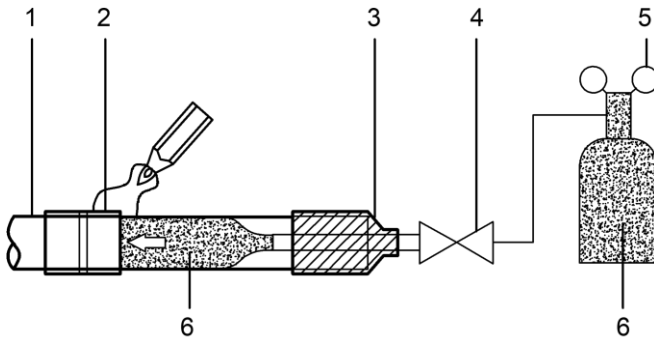

Legend	
1	Copper piping
2	Section being brazed
3	Nitrogen connection
4	Hand valve
5	Pressure-reducing valve
6	Nitrogen

- When joining a shorter section of piping to a longer section, flow nitrogen from the shorter side to allow better displacement of air with nitrogen.
- If the distance from the point where nitrogen enters the piping to the joint to be brazed is long, ensure that the nitrogen is flowed for sufficient time to discharge all the air from the section to be brazed before commencing brazing.

Figure 3-3.6: Flowing nitrogen from shorter side during brazing

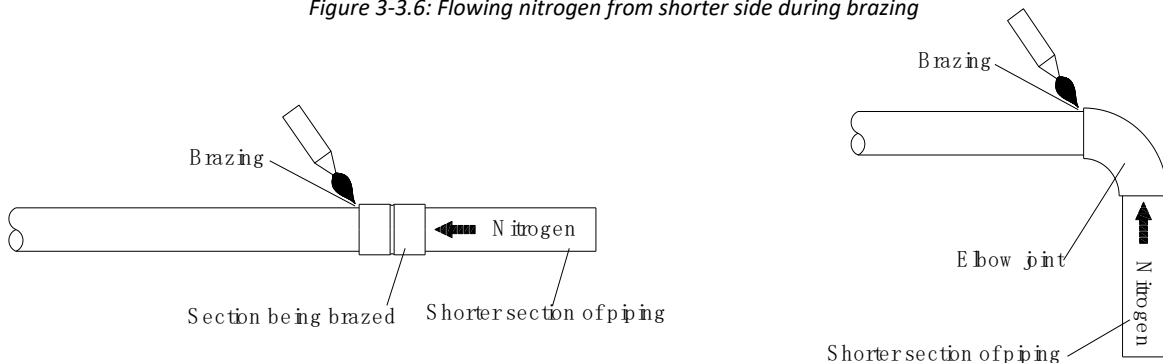

Box continued on next page ...

... box continued from previous page

### Piping orientation during brazing

Brazing should be conducted downwards or horizontally to avoid filler leakage.

Figure 3-3.7: Piping orientation during brazing

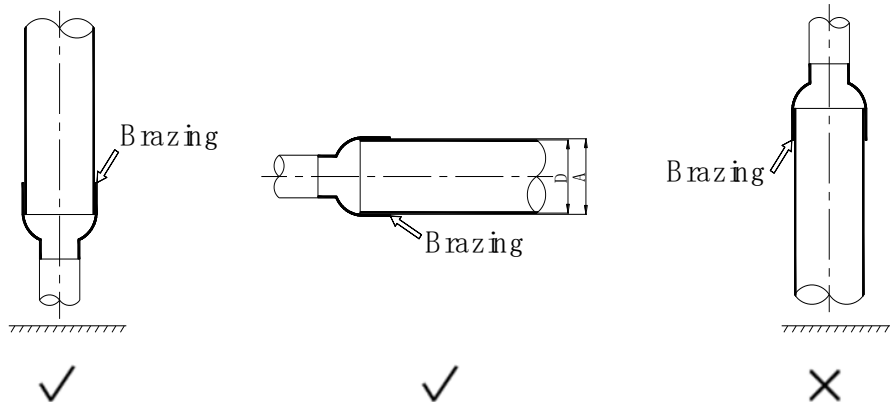

### Piping overlap during brazing

Table 3-3.5 specifies the minimum permissible piping overlap and the range of permissible gap sizes for brazed joints on piping of different diameters. Refer also to Figure 3-3.8.

Figure 3-3.8: Piping overlap and gap for brazed joints

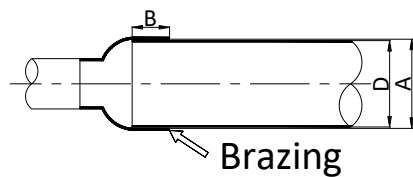

Legend	
A	Inner diameter of larger pipe
D	Outer diameter of smaller pipe
B	In-laid depth (overlap)

Table 3-3.5: Piping overlap and gap for brazed joints<sup>1</sup>

D (mm)	Minimum permissible B (mm)	Permissible A – D (mm)
5 < D < 8	6	0.05 - 0.21
8 < D < 12	7	
12 < D < 16	8	0.05 - 0.27
16 < D < 25	10	
25 < D < 35	12	0.05 - 0.35
35 < D < 45	14	

Notes:

1. A, B, D refer to the dimensions shown in Figure 3-5.7.

### Filler

- Use a copper/phosphorus brazing alloy (BCuP) filler that does not require flux.
- Do not use flux. Flux can cause corrosion of piping and can affect the performance of compressor oil.
- Do not use anti-oxidants when brazing. Residue can clog piping and damage components.

### 3.8 Pipe Flushing

#### 3.8.1 Purpose

To remove dust, other particles and moisture, which could cause compressor malfunction if not flushed out before the system is run, the refrigerant piping should be flushed using nitrogen. As described in Part 3, 3.3.1 "Installation procedure", pipe flushing should be performed once the piping connections have been completed with the exception of the final connections to the hydronic box. That is, flushing should be performed once the outdoor unit have been connected but before the hydronic box is connected.

#### 3.8.2 Procedure

##### Notes for installers



##### Warning

Only use nitrogen for flushing. Using carbon dioxide risks leaving condensation in the piping. Oxygen, air, refrigerant, flammable gases and toxic gases must not be used for flushing. Use of such gases may result in fire or explosion.

##### Procedure

The liquid and gas sides can be flushed simultaneously; alternatively, one side can be flushed first and then Steps 1 to 6 repeated, for the other side. The flushing procedure is as follows:

1. Attach a pressure reducing valve to a nitrogen cylinder.
2. Connect the pressure reducing valve outlet to the inlet on the liquid (or gas) side of the outdoor unit.
3. Start to open the nitrogen cylinder valve and gradually increase the pressure to 0.5MPa.
4. Allow time for nitrogen to flow as far as the opening at hydronic box.
5. Flush the opening:
  - a) Using suitable material, such as a bag or cloth, press firmly against the opening at hydronic box.
  - b) When the pressure becomes too high to block with your hand, suddenly remove your hand allowing gas to rush out.
  - c) Repeatedly flush in this manner until no further dirt or moisture is emitted from the piping. Use a clean cloth to check for dirt or moisture being emitted. Seal the opening once it has been flushed.
6. Once flushing is complete, seal the opening to prevent dust and moisture from entering.

Figure 3-3.9: Pipe flushing using nitrogen

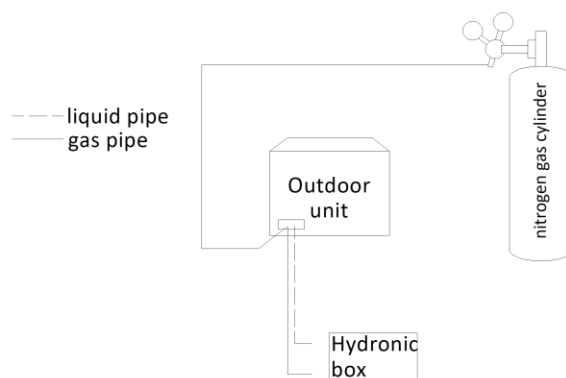

### 3.9 Gastightness Test

#### 3.9.1 Purpose

To prevent faults caused by refrigerant leakage, a gastightness test should be performed before system commissioning.

#### 3.9.2 Procedure

##### Notes for installers



##### Warning

Only dry nitrogen should be used for gastightness testing. Oxygen, air, flammable gases and toxic gases must not be used for gastightness testing. Use of such gases may result in fire or explosion.

##### Procedure

The gastightness test procedure is as follows:

##### Step 1

- Once the piping system is complete and the hydronic box and outdoor unit have been connected, vacuum the piping to -0.1MPa.

##### Step 2

- Charge the piping with nitrogen at 0.3MPa and leave for at least 3 minutes to check large leakage, then 1.5MPa leave for at least 3 minutes to check small leakage, finally 4.3MPa leave for at least 24 hours to check micro leakage.
- After the test period of at least 24 hours, observe the pressure in the piping and assess whether or not the observed pressure indicates the presence of a leak. Allow for any change in ambient temperature over the test period by adjusting the reference pressure by 0.01MPa per 1°C of temperature difference. Adjusted reference pressure = Pressure at pressurization + (temperature at observation – temperature at pressurization) x 0.01MPa. Compare the observed pressure with the adjusted reference pressure. If they are the same, the piping has passed the gastightness test.
- If the observed pressure is lower than the adjusted reference pressure, the piping has failed the test. Refer to Part 3, 3.9.3 “Leak detection”. Once the leak has been found and fixed, the gastightness test should be repeated.

##### Step 3

- If not continuing straight to vacuum drying (see Part 3, 3.10 “Vacuum Drying”) once the gastightness test is complete, reduce the system pressure to 0.5-0.8MPa and leave the system pressurized until ready to carry out the vacuum drying procedure.

Figure 3-3.10: Gastightness test

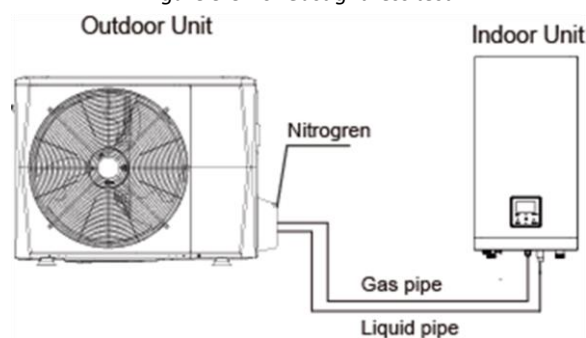

## Notes for installers



The general methods for identifying the source of a leak are as follows:

1. Audio detection: relatively large leaks are audible.
2. Touch detection: place your hand at joints to feel for escaping gas.
3. Soapy water detection: small leaks can be detected by the formation of bubbles when soapy water is applied to a joint.

Figure 3-3.11: Leak detection

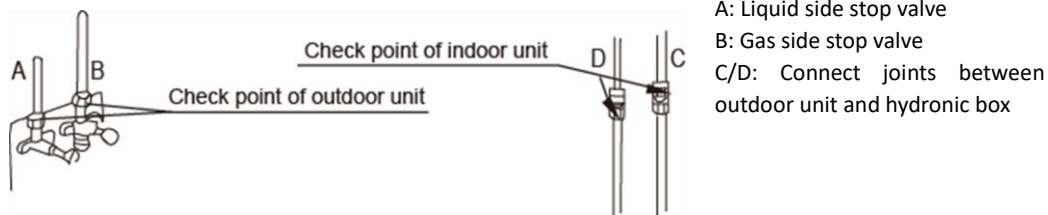

4. Refrigerant leak detection: for leaks that are difficult to detect, refrigerant leak detection may be used as follows:
  - a) Pressurize the piping with nitrogen at 0.3MPa.
  - b) Add refrigerant into the piping until the pressure reaches 0.5MPa.
  - c) Use a halogen refrigerant detector to find the leak.
  - d) If the leak source cannot be found, continuing charging with refrigerant to a pressure of 4.3 MPa and then search again.

### 3.10 Vacuum Drying

#### 3.10.1 Purpose

Vacuum drying should be performed in order to remove moisture and non-condensable gases from the system. Removing moisture prevents ice formation and oxidization of copper piping or other internal components. The presence of ice particles in the system would cause abnormal operation, whilst particles of oxidized copper can cause compressor damage. The presence of non-condensable gases in the system would lead to pressure fluctuations and poor heat exchange performance.

Vacuum drying also provides additional leak detection (in addition to the gas tightness test).

**3.10.2 Procedure**
**Notes for installers**

During vacuum drying, a vacuum pump is used to lower the pressure in the piping to the extent that any moisture present evaporates. At 5mmHg (755mmHg below typical atmospheric pressure) the boiling point of water is 0°C. Therefore a vacuum pump capable of maintaining a pressure of -755mmHg or lower should be used. Using a vacuum pump with a discharge in excess of 4L/s and a precision level of 0.02mmHg is recommended.

**Caution**

- Before performing vacuum drying, make sure that the outdoor unit stop valves are firmly closed.
- Once the vacuum drying is complete and the vacuum pump is stopped, the low pressure in the piping could suck vacuum pump lubricant into the air conditioning system. The same could happen if the vacuum pump stops unexpectedly during the vacuum drying procedure. Mixing of pump lubricant with compressor oil could cause compressor malfunction and a one-way valve should therefore be used to prevent vacuum pump lubricant seeping into the piping system.

**Procedure**

The vacuum drying procedure is as follows:

**Step 1**

- Connect the blue (low pressure side) hose of a pressure gauge to the outdoor unit gas pipe stop valve, the red (high pressure side) hose to the outdoor unit liquid pipe stop valve and the yellow hose to the vacuum pump.

**Step 2**

- Start the vacuum pump and then open the pressure gauge valves to start vacuum the system.
- After 30 minutes, close the pressure gauge valves.
- After a further 5 to 10 minutes check the pressure gauge. If the gauge has returned to zero, check for leakages in the refrigerant piping.

**Step 3**

- Re-open the pressure gauge valves and continue vacuum drying for at least 2 hours and until a pressure difference of 756mmHg or more has been achieved. Once the pressure difference of at least 756mmHg has been achieved, continue vacuum drying for 2 hours.

**Step 4**

- Close the pressure gauge valves and then stop the vacuum pump.
- After 1 hour, check the pressure gauge. If the pressure in the piping has not increased, the procedure is finished. If the pressure has increased, check for leakages.
- After vacuum drying, **keep the blue and red hoses connected to the pressure gauge and to the outdoor unit stop valves**, in preparation for refrigerant charging (see Part 3, 3.11 “Charging Refrigerant”).

Figure 3-3.12: Pressure gauge





## 3.11 Charging Refrigerant

### 3.11.1 Calculating additional refrigerant charge

Calculate the added refrigerant according to the diameter and the length of the liquid side pipe of the outdoor unit/indoor unit connection. If the length of the liquid side pipe is less than 15 meters it is no need to add more refrigerant, so calculating the added refrigerant the length of the liquid side pipe must subtract 15 meters.

Table 3-3.6: Additional refrigerant charge

Refrigerant to be added	Model	L(m)	
		≤15m	>15m
Total additional refrigerant	4/6kW	0g	(L-15)*20g
	8/10/12/14/16kW	0g	(L-15)*38g

### 3.11.2 Adding refrigerant

#### Notes for installers



#### Caution

- Only charge refrigerant after performing a gas tightness test and vacuum drying.
- Never charge more refrigerant than required as doing so can lead to liquid hammering.
- Only use refrigerant R32 - charging with an unsuitable substance may cause explosions or accidents.
- Use tools and equipment designed for use with R32 to ensure required pressure resistance and to prevent foreign materials from entering the system.
- Refrigerant must be treated in accordance with applicable legislation.
- Always use protective gloves and protect your eyes when charging refrigerant.
- Open refrigerant containers slowly.
- Keep the site well ventilated, no ignition source and fire extinguisher in hand for R32 is a flammable refrigerant.

#### Procedure

The procedure for adding refrigerant is as follows:

##### Step 1

- Calculate additional refrigerant charge R (kg) (see Part 3, 3.11.1 "Calculating Additional Refrigerant Charge")

##### Step 2

- Place a tank of R32 refrigerant on a weighing scale. Turn the tank upside down to ensure refrigerant is charged in a liquid state.
- After vacuum drying (see Part 3, 3.10 "Vacuum Drying"), the blue and red pressure gauge hoses should still be connected to the pressure gauge and to the outdoor unit stop valves.
- Connect the yellow hose from the pressure gauge to the R32 refrigerant tank.

##### Step 3

- Open the valve where the yellow hose meets the pressure gauge, and open the refrigerant tank slightly to let the refrigerant eliminate the air. Caution: open the tank slowly to avoid freezing your hand.
- Set the weighing scale to zero.

Box continued on next page ...

... box continued from previous page

## Step 4

- Open the three valves on the pressure gauge to begin charging refrigerant.
- When the amount charged reaches R (kg), close the three valves. If the amount charged has not reached R (kg) but no additional refrigerant can be charged, close the three valves on the pressure gauge, run the outdoor unit in cooling mode, and then open the yellow and blue valves. Continue charging until the full R (kg) of refrigerant has been charged, then close the yellow and blue valves. Note: Before running the system, be sure to complete all test run checks as listed in Part 3, 8.15 "TEST RUN" and be sure to open stop valves as running the system with the stop valves closed would damage the compressor.

Figure 3-3.13: Charging refrigerant

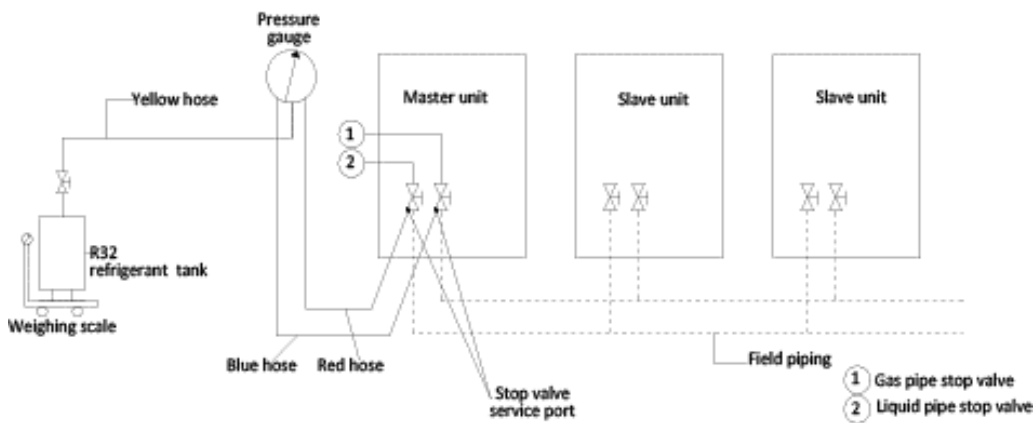

Pressure gauge

## 4 Water Pipework

### 4.1 Water Circuit Checks

Hydronic boxes are equipped with a water inlet and outlet for connection to a water circuit. MDV thermal Split units should only be connected to closed water circuits. Connection to an open water circuit would lead to excessive corrosion of the water piping. Only materials complying with all applicable legislation should be used.

Before continuing installation of the unit, check the following:

- The maximum water pressure  $\leq 3$  bar.
- The maximum water temperature  $\leq 70^{\circ}\text{C}$  according to safety device setting.
- Always use materials that are compatible with the water used in the system and with the materials used in the unit.
- Ensure that components installed in the field piping can withstand the water pressure and temperature.
- Drain taps must be provided at all low points of the system to permit complete drainage of the circuit during maintenance.
- Air vents must be provided at all high points of the system. The vents should be located at points that are easily accessible for service. An automatic air purge is provided inside the unit. Check that this air purge valve is not tightened so that automatic release of air in the water circuit is possible.

### 4.2 Water volume and sizing expansion vessels

The units are equipped with an expansion vessel of 8L that has a default pre-pressure of 1.5 bar. To assure proper operation of the unit, the pre-pressure of the expansion vessel might need to be adjusted.

- Check that the total water volume in the installation, excluding the internal water volume of the unit, is at least 40L.
- Expansion vessel volume must fit the total water system volume.
- To size the expansion for the heating and cooling circuit.

The expansion vessel volume can follow the figure below:

Figure 3-4.1: Expansion vessel volume

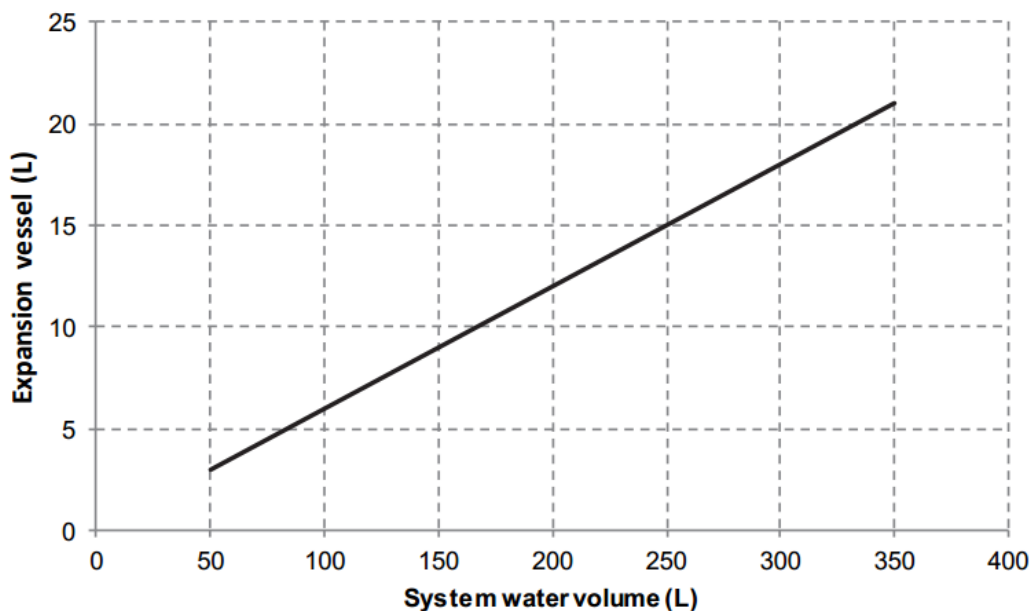

Notes:

- In most applications this minimum water volume will be satisfactory.
- In critical processes or in rooms with a high heat load though, extra water might be required.
- When circulation in each space heating loop is controlled by remotely controlled valves, it is important that this minimum water volume is kept even if all the valves are closed.

### 4.3 Water Circuit Connection

Water connections must be made correctly in accordance with the labels on the hydronic box, with respect to the water inlet and water outlet. If air, moisture or dust gets in the water circuit, problems may occur. Therefore, always take into account the following when connecting the water circuit:

- Use clean pipes only.
- Hold the pipe end downwards when removing burrs
- Cover the pipe end when inserting it through a wall to prevent dust and dirt entering.
- Use a good thread sealant for sealing the connections. The sealing must be able to withstand the pressures and temperatures of the system.
- When using non-copper metallic piping, be sure to insulate the two kinds of materials from each other to prevent galvanic corrosion.
- For copper is a soft material, use appropriate tools for connecting the water circuit. Inappropriate tools will cause damage to the pipes

### 4.4 Water Circuit Anti-freeze Protection

Ice formation can cause damage to the hydronic system. All internal hydronic parts are insulated to reduce heat loss. Insulation must also be added to the field piping.

- The software contains special functions using the heat pump to protect the entire system against freezing. When the temperature of the water flow in the system drops to a certain value, the unit will heat the water, either using the heat pump, or the backup heater. The freeze protection function will turn off only when the temperature increases to a certain value.
- In event of a power failure, the above features would not protect the unit from freezing. Since a power failure could happen when the unit is unattended, the supplier recommends use anti-freeze fluid to the water system.
- Depending on the expected lowest outdoor temperature, make sure the water system is filled with a concentration of glycol as mentioned in the table below. When glycol is added to the system, the freezing point of water will be lower and the performance of the unit will be affected. The correction factor of the unit capacity, flow rate and pressure drop of the system is listed in the table 3-4.1 and 3-4.2

Table 3-4.1: Ethylene Glycol(Toxic)

Concentration of ethylene glycol (%)	Modification coefficient				Minimum outdoor temperature (°C)
	Cooling capacity modification	Power input modification	Water resistance	Water flow modification	
0	1.000	1.000	1.000	1.000	0
10	0.984	0.998	1.118	1.019	-5
20	0.973	0.995	1.268	1.051	-15
30	0.965	0.992	1.482	1.092	-25

Table 3-4.2: Propylene Glycol(Low Toxic; Including the necessary inhibitors, classified as Category III according to EN1717)

Concentration of propylene glycol (%)	Modification coefficient				Minimum outdoor temperature (°C)
	Cooling capacity modification	Power input modification	Water resistance	Water flow modification	
0	1.000	1.000	1.000	1.000	0
10	0.976	0.996	1.071	1.000	-4
20	0.961	0.992	1.189	1.016	-12
30	0.948	0.988	1.380	1.034	-20

Glycol absorbs water from its environment. Therefore do NOT add glycol that has been exposed to air. Leaving the cap off

the glycol container causes the concentration of water to increase. The glycol concentration is then lower than assumed. As a result, the hydraulic components might freeze up after all. Take preventive actions to ensure a minimal exposure of the glycol to air.

Due to the presence of glycol, corrosion of the system is possible. Uninhibited glycol will turn acidic under the influence of oxygen. This process is accelerated by presence of copper and at higher temperatures. The acidic uninhibited glycol attacks metal surfaces and forms galvanic corrosion cells that cause severe damage to the system. It is of extreme importance:

- That the water treatment is correctly executed by a qualified water specialist.
- That a glycol with corrosion inhibitors is selected to counteract acids formed by the oxidation of glycols.
- That in case of an installation with a domestic hot water tank, only the use of propylene glycol is allowed. If the system does NOT contain a domestic hot water tank, then you can use either propylene glycol or ethylene glycol;
- That no automotive glycol is used because their corrosion inhibitors have a limited lifetime and contain silicates that can foul or plug the system;
- That galvanized piping is not used in glycol systems since it may lead to the precipitation of certain elements in the glycol's corrosion inhibitor;
- To ensure that the glycol is compatible with the materials used in the system.
- Protection against bursting: the glycol will prevent the piping from bursting, but NOT the liquid inside the piping from freezing.
- Protection against freezing: the glycol will prevent the liquid inside the piping from freezing.
- The required concentration might differ depending on the type of glycol. ALWAYS compare the requirements from the table above with the specifications provided by the glycol manufacturer. If necessary, meet the requirements set by the glycol manufacturer.
- If the liquid in the system is frozen, the pump will NOT be able to start. Mind that if you only prevent the system from bursting, the liquid inside might still freeze.
- When water is at standstill inside the system, the system is very likely to freeze and get damaged.

## 4.5 Water Flow Switch

Water may enter into the flow switch and cannot be drained out and may freeze when the temperature is low enough. The flow switch should be removed and dried, then can be reinstalled in the unit.

- Counterclockwise rotation, remove the water flow switch.
- Drying the water flow switch completely.

Figure 3-4.2: Water flow switch

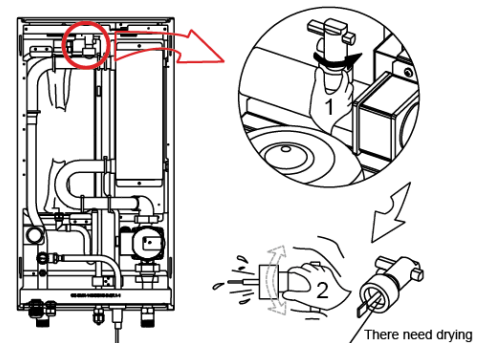

## 4.6 Adding Water

- Connect the water supply to the fill valve and open the valve.
- Make sure the automatic air purge valve is open (at least 2 turns).
- Fill with water until the manometer indicates a pressure of approximately 2.0 bars. Remove air in the circuit as much as possible using the air purge valve. Air in the water circuit could lead to malfunction of the backup electric heater.

## 4.7 Water Piping Insulation

The complete water circuit including all piping, water piping must be insulated to prevent condensation during cooling operation and reduction of the heating and cooling capacity as well as prevention of freezing of the outside water piping during winter. The insulation material should at least of B1 fire resistance rating and complies with all applicable legislation. The thickness of the sealing materials must be at least 13mm with thermal conductivity 0.039W/mK in order to prevent freezing on the outside water piping. If the outdoor ambient temperature is higher than 30°C and the humidity is higher than RH 80%, the thickness of the sealing materials should be at least 20mm in order to avoid condensation on the surface of the seal.

## 5 Electrical Wiring

### 5.1 General

#### Notes for installers



##### Caution

- All installation and wiring must be carried out by competent and suitably qualified, certified and accredited professionals and in accordance with all applicable legislation.
- Electrical systems should be grounded in accordance with all applicable legislation.
- Overcurrent circuit breakers and residual-current circuit breakers (ground fault circuit interrupters) should be used in accordance with all applicable legislation.
- Wiring patterns shown in this data book are general connection guides only and are not intended for, or to include all details for, any specific installation.
- The water piping, power wiring and communication wiring are typically run in parallel. However the communication wiring should not be bound together with power wiring. To prevent signal interference, the power wiring and communication wiring should not be run in the same conduit. If the power supply is less than 10A, a separation of at least 300mm between power wiring and communication wiring conduits should be maintained; if the power supply is in the range 10A to 50A then a separation of at least 500mm should be maintained.

### 5.2 Precautions

- Fix cables so that cables do not make contact with the pipes (especially on the high pressure side).
- Secure the electrical wiring with cable ties so that it does not come in contact with the piping, particularly on the high-pressure side.
- Make sure no external pressure is applied to the terminal connectors.
- When installing the ground fault circuit interrupter make sure that it is compatible with the inverter (resistant to high frequency electrical noise) to avoid unnecessary opening of the ground fault circuit interrupter
- This unit is equipped with an inverter. Installing a phase advancing capacitor not only reduce the power factor improvement effect, but also may cause abnormal heating of the capacitor due to high frequency waves. Never install a phase advancing capacitor as it could lead to an accident.

### 5.3 Guidance

- Most field wiring on the unit is to be made on the terminal block inside the switch box. To gain access to the terminal block, remove the switch box service panel.
- Fix all cables using cable ties.
- A dedicated power circuit is required for the backup electric heater.
- Installation equipped with a domestic hot water tank (field supplied) requires a dedicated power circuit for the immersion heater.

Secure the wiring in the order shown below:

- Lay out the electrical wiring so that the front cover does not rise up when doing wiring work and attach the front cover securely.
- Follow the electric wiring diagrams for electrical wiring works. Refer to Figure 2-4:1 to Figure 2-4:5 in part 2, 4 “Wiring Diagram”.
- Install the wires and fix the cover firmly so that the cover may be fit in properly.

## 5.4 Wiring Overview

Figure 3-5.1: Wiring overview

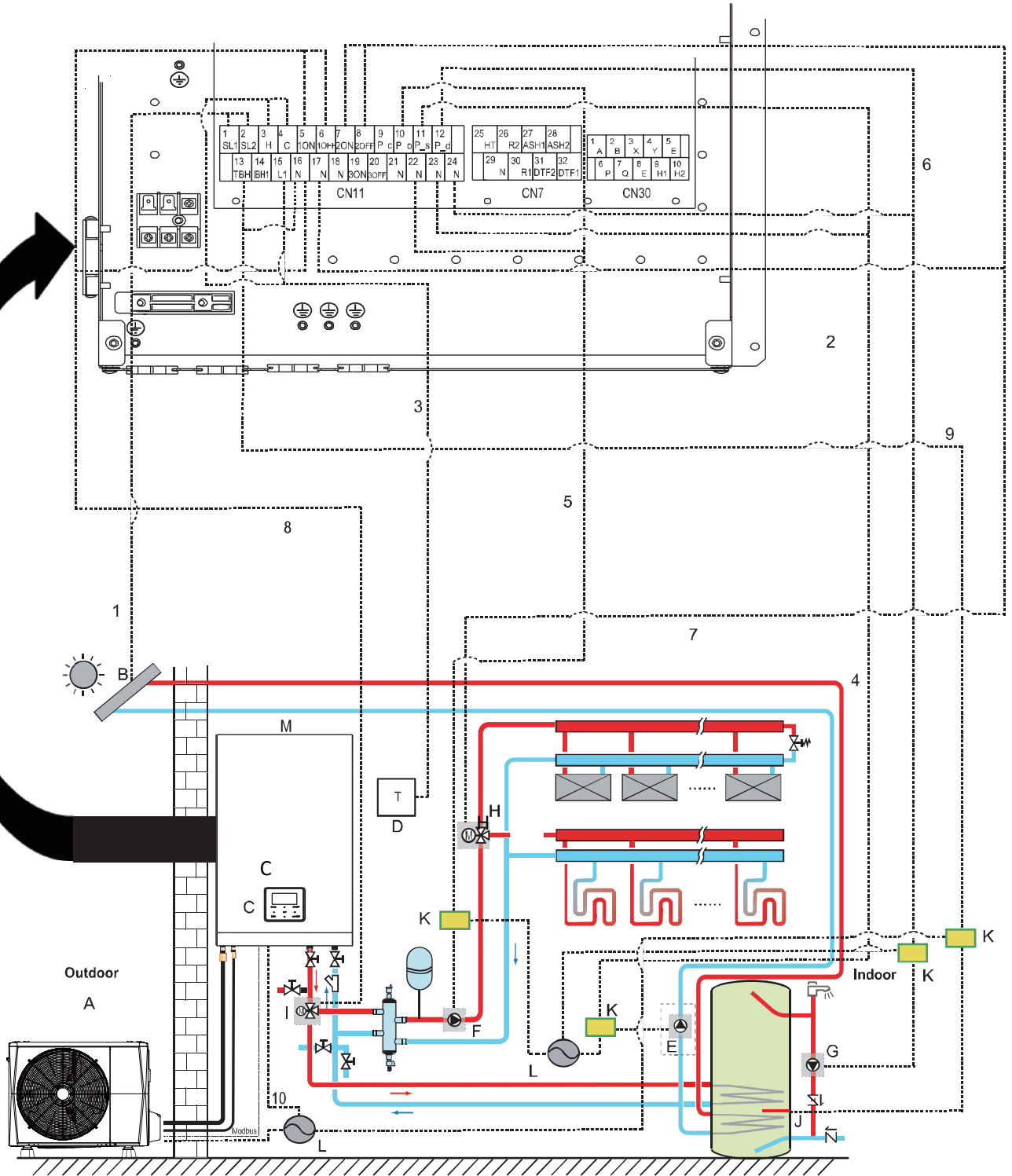

Legend			
A	Outdoor unit	H	SV2: 3-way valve (field supply)
B	Solar energy kit (field supplied)	I	SV1: 3-way valve for domestic hot water tank (field supply)
C	User interface	J	Booster heater
D	High voltage room thermostat (field supplied)	K	Contacteur
E	P_s: Solar pump (field supply)	L	Power supply
F	P_o: Outside circulation pump (field supply)	M	Indoor unit
G	P_d: DHW pump (field supply)		

Table 3-5.1: Wiring requirements

Item	Description	Current	Required number of conductors	Maximum running current
1	Solar energy kit signal cable	AC	2	200mA
2	User interface cable	AC	5	200mA
3	Room thermostat cable	AC	2	200mA <sup>1</sup>
4	Solar pump control cable	AC	2	200mA <sup>1</sup>
5	Outside circulation pump control cable	AC	2	200mA <sup>1</sup>
6	DHW pump control cable	AC	2	200mA <sup>1</sup>
7	SV2: 3-way valve control cable	AC	3	200mA <sup>1</sup>
8	SV1: 3-way valve control cable	AC	3	200mA <sup>1</sup>
9	Booster heater control cable	AC	2	200mA <sup>1</sup>
10	Power supply cable for indoor unit	AC	2+GND	0.4A

Notes:

1. Minimum cable section AWG18 (0.75 mm<sup>2</sup>)
2. The thermistor cable are delivered with the unit: if the current of the load is large, an AC contactor is needed.



### 6 DIP Switch Settings

DIP switch S1,S2 is located on the hydraulic module main control board and allows configuration of additional heating source thermistor installation, the second inner backup heater installation, etc. Refer to Table 3-6.1 and to the MDV thermal Split Service Manual, Part 4, 2.2 "Main PCB for Hydronic System".

Switch		ON=1	OFF=0
<p><b>S1</b></p>	1/2	0/0=IBH(One-step control) 0/1=IBH(Two-step control) 1/1=IBH(Three-stage control)	
	3/4	0/0=Without IBH and AHS 1/0=With IBH 0/1=With AHS for heating mode 1/1=With AHS for heating mode and DHW mode	
<p><b>S2</b></p>	1	Start pumpo after 24 hours will be invalid	Start pumpo after 24 hours will be valid
	2	without TBH	with TBH
	3/4	00=pump 1 01=pump 2 10=pump 3 11=pump 4	
<p><b>S4</b></p>	1	Reserved	Reserved
	2	IBH for DHW=valid	IBH for DHW=invalid
	3/4	Reserved	

### 7 Internal Circulation Pump

The pump is controlled via a digital low-voltage pulse-width modulation signal which means that the speed of rotation depends on the input signal. The speed changes as a function of the input profile. The relationship between external static pressure and water flow rate is described in Part 2, 7 "Hydronic Performance".

Figure 3-7.1: Internal circulator pump

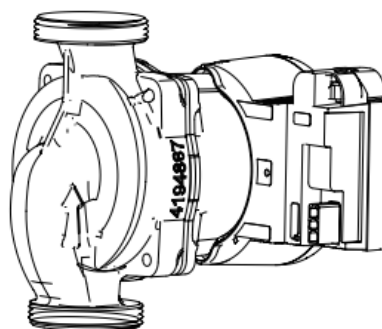

## 8 User Interface Field Settings

### 8.1 Introduction

During installation, the MDV thermal settings and parameters should be configured by the installer to suit the installation configuration, climate conditions and end-user preferences. The relevant settings are accessible and programmable through the **FOR SERVICEMAN** menu on the MDV thermal user interface. The user interface menus and settings can be navigated using the user interface's touch-sensitive keys, as detailed in Table 3-8.1.

Figure 3-8.1: User interface

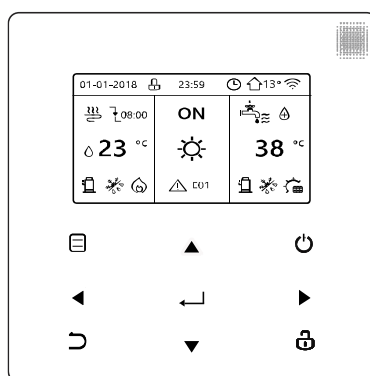
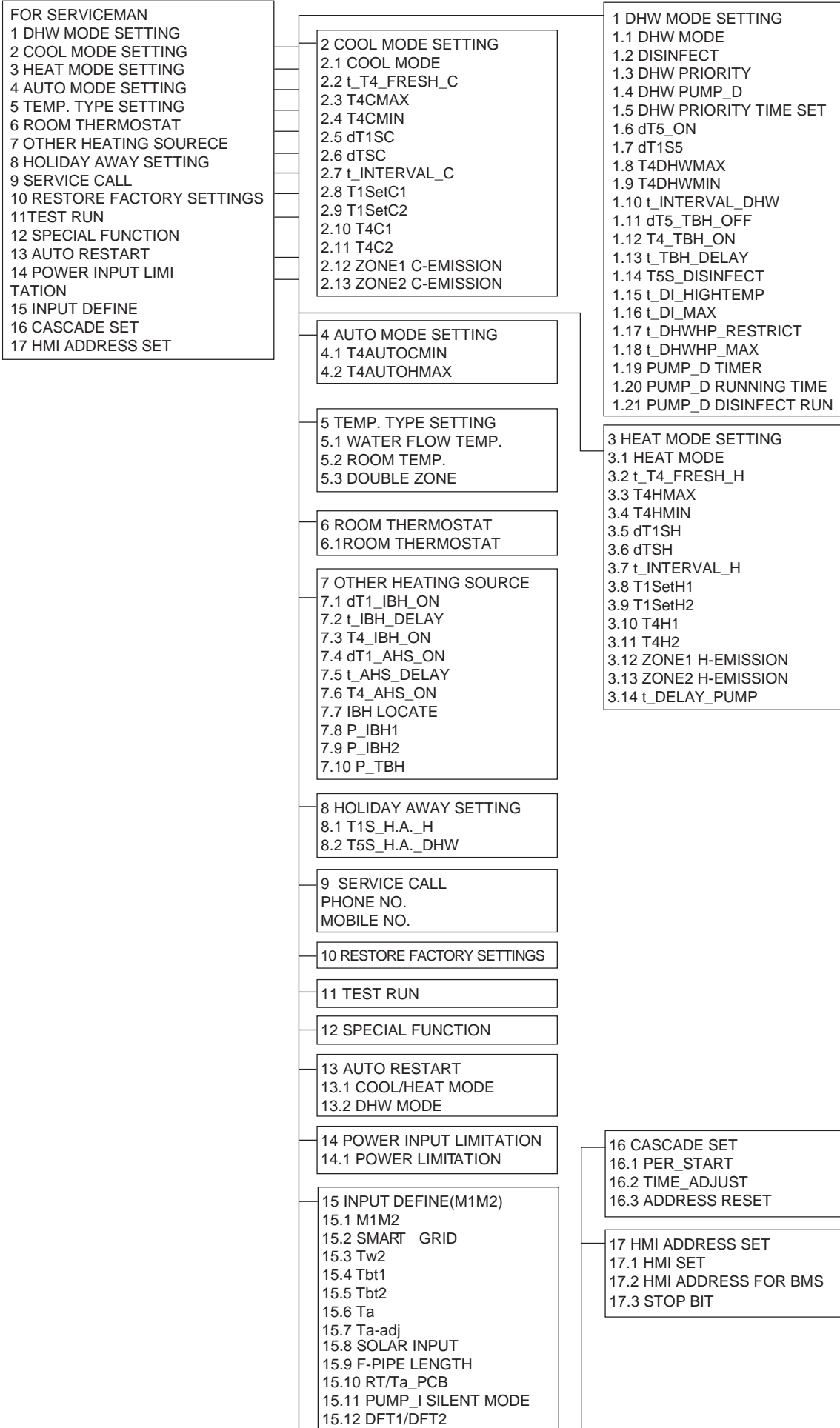

Table 3-8.1: User interface keys

Keys	Function
	Go to the menu structure(on the home page)
	Navigate the cursor on the display
	Navigate in the menu structure
	Adjust settings
	Turn on/off the space heating/cooling operation or DHW mode Turn on/off functions in the menu structure
	Come back to the up level
	Long press for unlock/lock the controller Unlock /lock some functions such as "DHW temperature adjusting"
	Go to the next step when programming a schedule in the menu structure and confirm a selection to enter in the submenu of the menu structure.

## 8.2 Menu Structure



## 8.3 FOR SERVICEMAN Menu

**FOR SERVICEMAN** allows installers to input the system configuration and set the system parameters. To enter **FOR SERVICEMAN**, go to **MENU > FOR SERVICEMAN**.

Enter the password, using ◀ ▶ to navigate between digits and using ▼ ▲ to adjust the numerical values, and then press **OK**. The password is 234. Refer to Figure 3-8.2

Then the following pages will be displayed after putting the password. Refer to Figure 3-8.3

Figure 3-8.2: FOR SERVICEMAN password screen

FOR SERVICEMAN		
Please input password:		
2	3	4
← ENTER	↕ ADJUST	→

Figure 3-8.3: FOR SERVICEMAN menu

<table border="1"> <tr> <td>FOR SERVICEMAN</td> <td style="text-align: right;">1/3</td> </tr> <tr> <td><b>1. DHW MODE SETTING</b></td> <td></td> </tr> <tr> <td>2. COOL MODE SETTING</td> <td></td> </tr> <tr> <td>3. HEAT MODE SETTING</td> <td></td> </tr> <tr> <td>4. AUTO MODE SETTING</td> <td></td> </tr> <tr> <td>5. TEMP.TYPE SETTING</td> <td></td> </tr> <tr> <td>6. ROOM THERMOSTAT</td> <td></td> </tr> <tr> <td>← ENTER</td> <td style="text-align: right;">↕</td> </tr> </table>	FOR SERVICEMAN	1/3	<b>1. DHW MODE SETTING</b>		2. COOL MODE SETTING		3. HEAT MODE SETTING		4. AUTO MODE SETTING		5. TEMP.TYPE SETTING		6. ROOM THERMOSTAT		← ENTER	↕	<table border="1"> <tr> <td>FOR SERVICEMAN</td> <td style="text-align: right;">2/3</td> </tr> <tr> <td><b>7. OTHER HEATING SOURCE</b></td> <td></td> </tr> <tr> <td>8. HOLIDAY AWAY SETTING</td> <td></td> </tr> <tr> <td>9. SERVICE CALL SETTING</td> <td></td> </tr> <tr> <td>10. RESTORE FACTORY SETTINGS</td> <td></td> </tr> <tr> <td>11. TEST RUN</td> <td></td> </tr> <tr> <td>12. SPECIAL FUNCTION</td> <td></td> </tr> <tr> <td>← ENTER</td> <td style="text-align: right;">↕</td> </tr> </table>	FOR SERVICEMAN	2/3	<b>7. OTHER HEATING SOURCE</b>		8. HOLIDAY AWAY SETTING		9. SERVICE CALL SETTING		10. RESTORE FACTORY SETTINGS		11. TEST RUN		12. SPECIAL FUNCTION		← ENTER	↕	<table border="1"> <tr> <td>FOR SERVICEMAN</td> <td style="text-align: right;">3/3</td> </tr> <tr> <td><b>13. AUTO RESTART</b></td> <td></td> </tr> <tr> <td>14. POWER INPUT LIMITATION</td> <td></td> </tr> <tr> <td>15. INPUT DEFINE</td> <td></td> </tr> <tr> <td>16. CASCADE SET</td> <td></td> </tr> <tr> <td>17. HMI ADDRESS SET</td> <td></td> </tr> <tr> <td>← ENTER</td> <td style="text-align: right;">↕</td> </tr> </table>	FOR SERVICEMAN	3/3	<b>13. AUTO RESTART</b>		14. POWER INPUT LIMITATION		15. INPUT DEFINE		16. CASCADE SET		17. HMI ADDRESS SET		← ENTER	↕
FOR SERVICEMAN	1/3																																															
<b>1. DHW MODE SETTING</b>																																																
2. COOL MODE SETTING																																																
3. HEAT MODE SETTING																																																
4. AUTO MODE SETTING																																																
5. TEMP.TYPE SETTING																																																
6. ROOM THERMOSTAT																																																
← ENTER	↕																																															
FOR SERVICEMAN	2/3																																															
<b>7. OTHER HEATING SOURCE</b>																																																
8. HOLIDAY AWAY SETTING																																																
9. SERVICE CALL SETTING																																																
10. RESTORE FACTORY SETTINGS																																																
11. TEST RUN																																																
12. SPECIAL FUNCTION																																																
← ENTER	↕																																															
FOR SERVICEMAN	3/3																																															
<b>13. AUTO RESTART</b>																																																
14. POWER INPUT LIMITATION																																																
15. INPUT DEFINE																																																
16. CASCADE SET																																																
17. HMI ADDRESS SET																																																
← ENTER	↕																																															

## 8.4 DHW MODE SETTING Menu

### 8.4.1 DHW MODE SETTING menu overview

**MENU > FOR SERVICEMAN > DHW MODE SETTING**

Figure 3-8.4: DHW MODE SETTING menu

<table border="1"> <tr> <td>1 DHW MODE SETTING</td> <td style="text-align: right;">1/5</td> </tr> <tr> <td>1.1 DHW MODE</td> <td style="text-align: right;"><b>YES</b></td> </tr> <tr> <td>1.2 DISINFECT</td> <td style="text-align: right;">YES</td> </tr> <tr> <td>1.3 DHW PRIORITY</td> <td style="text-align: right;">YES</td> </tr> <tr> <td>1.4 DHW PUMP_D</td> <td style="text-align: right;">YES</td> </tr> <tr> <td>1.5 DHW PRIORITY TIME SET</td> <td style="text-align: right;">NON</td> </tr> <tr> <td>↕ ADJUST</td> <td style="text-align: right;">▶</td> </tr> </table>	1 DHW MODE SETTING	1/5	1.1 DHW MODE	<b>YES</b>	1.2 DISINFECT	YES	1.3 DHW PRIORITY	YES	1.4 DHW PUMP_D	YES	1.5 DHW PRIORITY TIME SET	NON	↕ ADJUST	▶	<table border="1"> <tr> <td>1 DHW MODE SETTING</td> <td style="text-align: right;">2/5</td> </tr> <tr> <td>1.6 dT5_ON</td> <td style="text-align: right;"><b>5</b> °C</td> </tr> <tr> <td>1.7 dT1S5</td> <td style="text-align: right;">10°C</td> </tr> <tr> <td>1.8 T4DHWMAX</td> <td style="text-align: right;">43°C</td> </tr> <tr> <td>1.9 T4DHWMIN</td> <td style="text-align: right;">-10°C</td> </tr> <tr> <td>1.10 t_INTERVAL_DHW</td> <td style="text-align: right;">5 MIN</td> </tr> <tr> <td>↕ ADJUST</td> <td style="text-align: right;">▶</td> </tr> </table>	1 DHW MODE SETTING	2/5	1.6 dT5_ON	<b>5</b> °C	1.7 dT1S5	10°C	1.8 T4DHWMAX	43°C	1.9 T4DHWMIN	-10°C	1.10 t_INTERVAL_DHW	5 MIN	↕ ADJUST	▶	<table border="1"> <tr> <td>1 DHW MODE SETTING</td> <td style="text-align: right;">3/5</td> </tr> <tr> <td>1.11 dT5_TBH_OFF</td> <td style="text-align: right;"><b>5</b> °C</td> </tr> <tr> <td>1.12 T4_TBH_ON</td> <td style="text-align: right;">5 °C</td> </tr> <tr> <td>1.13 t_TBH_DELAY</td> <td style="text-align: right;">30 MIN</td> </tr> <tr> <td>1.14 T5S_DISINFECT</td> <td style="text-align: right;">65°C</td> </tr> <tr> <td>1.15 t_DI_HIGHTEMP.</td> <td style="text-align: right;">15MIN</td> </tr> <tr> <td>↕ ADJUST</td> <td style="text-align: right;">▶</td> </tr> </table>	1 DHW MODE SETTING	3/5	1.11 dT5_TBH_OFF	<b>5</b> °C	1.12 T4_TBH_ON	5 °C	1.13 t_TBH_DELAY	30 MIN	1.14 T5S_DISINFECT	65°C	1.15 t_DI_HIGHTEMP.	15MIN	↕ ADJUST	▶
1 DHW MODE SETTING	1/5																																											
1.1 DHW MODE	<b>YES</b>																																											
1.2 DISINFECT	YES																																											
1.3 DHW PRIORITY	YES																																											
1.4 DHW PUMP_D	YES																																											
1.5 DHW PRIORITY TIME SET	NON																																											
↕ ADJUST	▶																																											
1 DHW MODE SETTING	2/5																																											
1.6 dT5_ON	<b>5</b> °C																																											
1.7 dT1S5	10°C																																											
1.8 T4DHWMAX	43°C																																											
1.9 T4DHWMIN	-10°C																																											
1.10 t_INTERVAL_DHW	5 MIN																																											
↕ ADJUST	▶																																											
1 DHW MODE SETTING	3/5																																											
1.11 dT5_TBH_OFF	<b>5</b> °C																																											
1.12 T4_TBH_ON	5 °C																																											
1.13 t_TBH_DELAY	30 MIN																																											
1.14 T5S_DISINFECT	65°C																																											
1.15 t_DI_HIGHTEMP.	15MIN																																											
↕ ADJUST	▶																																											
<table border="1"> <tr> <td>1 DHW MODE SETTING</td> <td style="text-align: right;">4/5</td> </tr> <tr> <td>1.16 t_DI_MAX</td> <td style="text-align: right;"><b>210</b> MIN</td> </tr> <tr> <td>1.17 t_DHWHP_RESTRICT</td> <td style="text-align: right;">30 MIN</td> </tr> <tr> <td>1.18 t_DHWHP_MAX</td> <td style="text-align: right;">120 MIN</td> </tr> <tr> <td>1.19 PUMP_D TIMER</td> <td style="text-align: right;">YES</td> </tr> <tr> <td>1.20 PUMP_D RUNNING TIME</td> <td style="text-align: right;">5 MIN</td> </tr> <tr> <td>↕ ADJUST</td> <td style="text-align: right;">▶</td> </tr> </table>	1 DHW MODE SETTING	4/5	1.16 t_DI_MAX	<b>210</b> MIN	1.17 t_DHWHP_RESTRICT	30 MIN	1.18 t_DHWHP_MAX	120 MIN	1.19 PUMP_D TIMER	YES	1.20 PUMP_D RUNNING TIME	5 MIN	↕ ADJUST	▶	<table border="1"> <tr> <td>1 DHW MODE SETTING</td> <td style="text-align: right;">5/5</td> </tr> <tr> <td>1.21 PUMP_D DISINFECT RUN</td> <td style="text-align: right;"><b>NON</b></td> </tr> <tr> <td> </td> <td></td> </tr> <tr> <td> </td> <td></td> </tr> <tr> <td> </td> <td></td> </tr> <tr> <td> </td> <td></td> </tr> <tr> <td>↕ ADJUST</td> <td style="text-align: right;">▶</td> </tr> </table>	1 DHW MODE SETTING	5/5	1.21 PUMP_D DISINFECT RUN	<b>NON</b>									↕ ADJUST	▶															
1 DHW MODE SETTING	4/5																																											
1.16 t_DI_MAX	<b>210</b> MIN																																											
1.17 t_DHWHP_RESTRICT	30 MIN																																											
1.18 t_DHWHP_MAX	120 MIN																																											
1.19 PUMP_D TIMER	YES																																											
1.20 PUMP_D RUNNING TIME	5 MIN																																											
↕ ADJUST	▶																																											
1 DHW MODE SETTING	5/5																																											
1.21 PUMP_D DISINFECT RUN	<b>NON</b>																																											
↕ ADJUST	▶																																											

In **DHW MODE SETTING** the following parameters should be set.

**DHW MODE** enables or disables DHW mode. For installations with DHW tanks, select **YES** to enable DHW mode. For installations without DHW tanks, select **NON** to disable DHW mode.

**DISINFECT** sets whether or not the disinfection operation is performed.

**DHW PRIORITY** sets whether domestic hot water heating or space heating/cooling takes priority. If **NON** is selected in the **DHW PRIORITY** mode, when it is available and the space heating/cooling is **OFF**, the heat pump will heat the water as required. If space heating/cooling is **ON**, the water will be heated as required when the immersion heater is unavailable.

# MDV thermal Arctic Split



Only when the space heating/cooling is **OFF** will the heat pump operate to heat domestic water.

**DHW PUMP** sets whether or not the DHW pump is controlled by the MDV thermal Split unit. If the DHW pump is to be controlled by the MDV thermal Split, select **YES**. If the DHW pump is not to be controlled by the MDV thermal Split unit, select **NON**.

**DHW PUMP PRIORITY TIME SET** set the operation time of DHW during **DHW PRIORITY** mode.

**dT5\_ON** sets the temperature difference between the DHW set temperature (T5S) and the DHW tank water temperature (T5) above which the heat pump providing heated water to the DHW tank. When  $T5S - T5 \geq dT5\_ON$  the heat pump providing heated water to the DHW tank.

Note: When the heat pump's leaving water temperature is above the DHW mode leaving water temperature operating limit (T5stop), the heat pump does not provide heated water to the DHW tank. The DHW mode leaving water temperature operating limit is related to ambient temperature as shown in Figure 2-6.3 in Part 2, 6 "Operating Limits".

**dT1S5** sets the heat pump's leaving water set temperature (T1S) relative to DHW tank water temperature (T5). For DHW mode, the user sets the DHW set temperature (T5S) on the main screen and cannot manually set T1S. T1S is set as  $T1S = T5 + dT1S5$ .

Figure 3-8.6 illustrates the operation of the heat pump and immersion heater(optional) in DHW mode. If the DHW tank water temperature (T5) is less than the minimum of the DHW set temperature (T5S) and the heat pump leaving water temperature operating limit (T5stop) (refer to Figure 2-6.3 in Part 2, 6 "Operating Limits") less **dT5\_ON**, the heat pump starts providing heated water to the DHW tank. After **t\_TBH\_delay** minutes have elapsed, the immersion heater is turned on. If T5 reaches T5stop, the heat pump stops but the immersion heater continues running until T5 has reached  $T5S + dT5\_TBH\_OFF$

**T4DHWMAX** sets the ambient temperature above which the heat pump will not operate in DHW mode. The highest value that **T4DHWMAX** can take is 43°C, which is the DHW mode upper ambient temperature operating limit of the heat pump.

**T4DHWMIN** sets the ambient temperature below which the heat pump will not operate in DHW mode. The lowest value that **T4DHWMIN** can take is -25°C, which is the DHW mode lower ambient temperature operating limit of the heat pump.

Figure 3-8.5: dT5\_ON

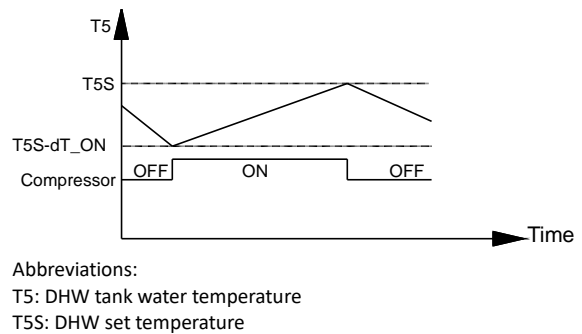

Figure 3-8.6: DHW mode operation

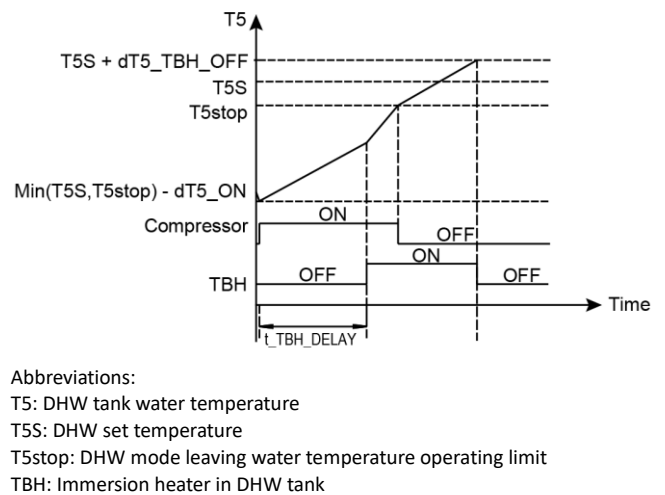

Figure 3-8.7: T4DHWMAX and T4DHWMIN



Abbreviations:  
 HP: Heat pump  
 TBH: DWH tank immersion heater  
 AHS: Additional heating source

**t\_INTERVAL\_DHW** sets the DHW mode compressor re-start delay. When the compressor stops running, it will not re-start until at least **t\_INTERVAL\_DHW** minutes have elapsed.

**dT5\_TBH\_OFF** sets the temperature difference between the DHW set temperature (T5S) and the DHW tank water temperature (T5) below which the immersion is not used. When  $T5 > \text{Min}(T5\text{Stop} + dT5\_TBH\_OFF, 65^\circ\text{C})$ , the immersion heater is off.

**T4\_TBH\_ON** sets the ambient temperature above which the immersion heater will not be used.

**t\_TBH\_DELAY** sets the delay between the compressor starting and the immersion heater being turned on.

**T5S\_DI** sets the DHW tank disinfection operation target temperature. Caution: during the disinfection operation (duration: **t\_DI\_MAX**) the domestic hot water temperature at the hot water taps will at times be equal to the value set for **T5S\_DI**.

**t\_DI\_HIGHTEMP** sets that length of time that the DHW tank disinfection operation target temperature is maintained.

**t\_DI\_MAX** sets the total duration of the DHW tank disinfect operation.

**t\_DHWHP\_RESTRICT** sets the maximum length of time that the heat pump will run in space heating or space cooling modes before switching to DHW mode, if a requirement for DHW mode exists. When running in space heating mode or space cooling mode, the heat pump becomes available for DHW mode either as soon as the space heating/cooling set temperatures have been reached (refer to Part 3, 8.5 "COOL MODE SETTING Menu" and Part 3, 8.6 "HEAT MODE SETTING Menu") or after **t\_DHWHP\_MAX** minutes have elapsed.

**t\_DHWHP\_MAX** sets the maximum length of time that the heat pump will run in DWH mode before switching to space heating mode or space cooling mode if a requirement for space heating/cooling modes exists. When running in DHW mode, the heat pump becomes available for space heating/cooling either as soon as the DHW tank water temperature (T5) reaches the DHW set temperature (T5S) or after **t\_DHWHP\_MAX** minutes have elapsed.

Figure 3-8.8: DHW tank disinfection

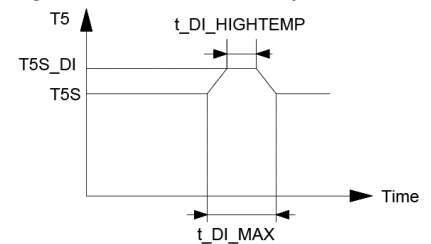

Abbreviations:  
T5: DHW tank water temperature  
T5S: DHW set temperature

Figure 3-8.9 illustrates the effects of **t\_DHWHP\_MAX** and **t\_DHWHP\_RESTRICT** when **DHW PRIORITY** is enabled. The heat pump initially runs in DWH mode. After **t\_DHWHP\_MAX** minutes, T5 has not reached

Figure 3-8.9: Operation in DHW PRIORITY

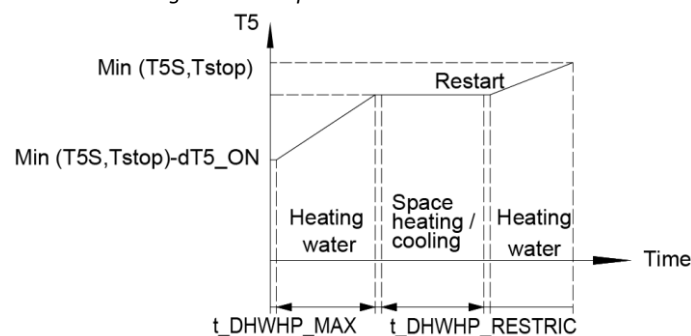

Abbreviations:  
T5: DHW tank water temperature  
T5S: DHW set temperature  
T5stop: DHW mode leaving water temperature operating limit

**DHW PUMP TIME RUN** sets whether or not the user is able to set the DHW pump (field supply) in DHW mode. For installations with a DHW pump, select ON so that the user is able to set pump start times.

**PUMP RUNNING TIME** sets the length of time the pump runs for at each of the user-specified start times on the **DHW PUMP** tab on the **DOMESTIC HOT WATER (DHW)** menu, if **TIMER RUNNING** is enabled.

**DHW PUMP DI RUN** sets whether or not the **DHW pump (field supply)** operates during the disinfection mode.

## 8.5 COOL MODE SETTING Menu

MENU > FOR SERVICEMAN > COOL MODE SETTING

Figure 3-8.10: COOL MODE SETTING menu

2 COOL MODE SETTING	1/3	2 COOL MODE SETTING	2/3	2 COOL MODE SETTING	3/3
2.1 COOL MODE	<b>YES</b>	2.6 dTSC	<b>2°C</b>	2.11 T4C2	<b>25°C</b>
2.2 t_T4_FRESH_C	2.0HRS	2.7 t_INTERVAL_C	5MIN	2.12 ZONE1 C-EMISSION	FCU
2.3 T4CMAX	43°C	2.8 T1SetC1	10°C	2.13 ZONE2 C-EMISSION	FLH
2.4 T4CMIN	20°C	2.9 T1SetC2	16°C		
2.5 dT1SC	5°C	2.10 T4C1	35°C		
ADJUST		ADJUST		ADJUST	

In **COOL MODE SETTING** the following parameters should be set.

**COOL MODE** enables or disables cooling mode. For installations with space cooling terminals, select **YES** to enable cooling mode. For installations without space cooling terminals, select **NON** to disable cooling mode.

**t\_T4\_FRESH\_C** sets the refresh time of cooling mode climate temperature curve.

**T4CMAX** sets the ambient temperature above which the heat pump will operate in cooling mode with lowest compressor frequency. The highest value that **T4CMAX** can take is 46°C, which is the cooling mode upper ambient temperature operating limit of the heat pump. Refer to Figure 3-8.11.

Figure 3-8.11: T4CMAX, T4CMIN

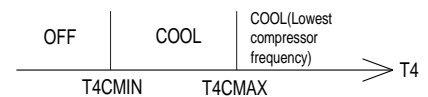

Abbreviations:  
T4: Outdoor ambient temperature

**T4CMIN** sets the ambient temperature below which the heat pump will not operate in cooling mode. The lowest value that **T4CMIN** can take is -5°C, which is the cooling mode lower ambient temperature operating limit of the heat pump. Refer to Figure 3-8.12.

**dT1SC** sets the minimum temperature difference between the heat pump leaving water temperature (T1) and the heat pump leaving water set temperature (T1S) at which the heat pump provides chilled water to the space cooling terminals. When  $T1 - T1S \geq dT1SC$  the heat pump provides chilled water to the space cooling terminals and when  $T1 \leq T1S$  the heat pump does not provide chilled water to the space cooling terminals.

Figure 3-8.12: dT1SC

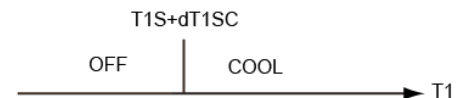

Abbreviations:  
T1: Heat pump leaving water temperature  
T1S: Heat pump leaving water set temperature

**dTSC** sets the temperature difference between the actual room temperature (Ta) and set room temperature (TS) above which the heat pump provides chilled water to the space cooling terminals. When  $Ta - TS \geq dTSC$  the heat pump provides chilled water to the space cooling terminals and when  $Ta \leq TS$  the heat pump does not provide chilled water to the space cooling terminals. Refer to Figure 3-8.18. **dTSC** is only applicable if **YES** is selected for **ROOM TEMP** in the **TEMP. TYPE SETTING** menu. Refer to Part 3, 8.8 "TEMP. TYPE SETTING Menu".

Figure 3-8.13: dTSC

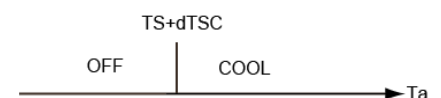

**t\_INTERVAL\_C** sets the cooling mode compressor re-start delay. When the compressor stops running, it will not re-start

until at least **t\_INTERVAL\_C** minutes have elapsed.

**T1SetC1** sets the temperature 1 of automatic setting curve for cooling mode.

**T1SetC2** sets the temperature 2 of automatic setting curve for cooling mode.

**T4C1** sets the ambient temperature 1 of automatic setting curve for cooling mode.

**T4C2** sets the ambient temperature 2 of automatic setting curve for cooling mode.

**ZONE1 C-EMISSION** sets the emission type of zone1 for cooling mode.

**ZONE2 C-EMISSION** sets the emission type of zone2 for cooling mode.

## 8.6 HEAT MODE SETTING Menu

### MENU > FOR SERVICEMAN > HEAT MODE SETTING

Figure 3-8.14: HEAT MODE SETTING menu

3 HEAT MODE SETTING 1/3	3 HEAT MODE SETTING 2/3	3 HEAT MODE SETTING 3/3
3.1 HEAT MODE <b>YES</b>	3.6 dTSH <b>2°C</b>	3.11 T4H2 <b>7°C</b>
3.2 t_T4_FRESH_H 2.0HRS	3.7 t_INTERVAL_H 5MIN	3.12 ZONE1 H-EMISSION RAD.
3.3 T4HMAX 16°C	3.8 T1SetH1 35°C	3.13 ZONE2 H-EMISSION FLH
3.4 T4HMIN -15°C	3.9 T1SetH2 28°C	3.14 t_DELAY_PUMP 2MIN
3.5 dT1SH 5°C	3.10 T4H1 -5°C	
ADJUST	ADJUST	ADJUST

In **HEAT MODE SETTING** the following parameters should be set.

**HEAT MODE** enables or disables heating mode.

**t\_T4\_FRESH\_H** sets the refresh time of heating model climate temperature curve.

**T4HMAX** sets the ambient temperature above which the heat pump will operate heating mode with lowest compressor frequency. The highest value that **T4HMAX** can take is 35°C, which is the heating mode upper ambient temperature operating limit of the heat pump. Refer to Figure 3-8.15.

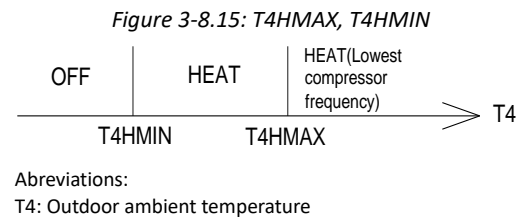

**T4HMIN** sets the ambient temperature below which the heat pump will not operate in heating mode. The lowest value that **T4HMIN** can take is -25°C, which is the heating mode lower ambient temperature operating limit of the heat pump. Refer to Figure 3-8.16.

**dT1SH** sets the temperature difference between the heat pump leaving water temperature (T1) and the heat pump leaving water set temperature (T1S) above which the heat pump provides heated water to the space heating terminals.

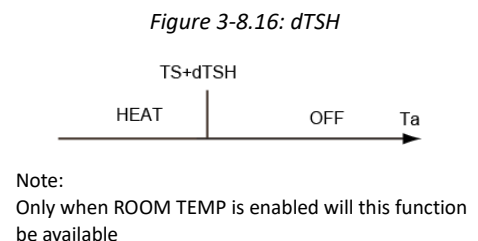



## MDV thermal Arctic Split



**dTSH** sets the temperature difference between the actual room temperature (Ta) and set room temperature (TS) above which the heat pump provides heated water to the space heating terminals. When  $TS - Ta \geq dTSH$  the heat pump provides heated water to the space heating terminals and when  $Ta \geq TS$  the heat pump does not provide heated water to the space heating terminals. Refer to Figure 3-8.23. **dTSH** is only relevant if **YES** is selected for **ROOM TEMP** in the **TEMP. TYPE SETTING** menu. Refer to Part 3, 8.8 “TEMP. TYPE SETTING Menu”.

**t\_INTERVAL\_H** sets the heating mode compressor re-start delay. When the compressor stops running, it will not re-start until at least **t\_INTERVAL\_H** minutes have elapsed.

**T1SetH1** sets the temperature 1 of automatic setting curve for heating mode.

**T1SetH2** sets the temperature 2 of automatic setting curve for heating mode.

**T4H1** sets the ambient temperature 1 of automatic setting curve for heating mode.

**T4H2** sets the ambient temperature 2 of automatic setting curve for heating mode.

**ZONE1 H-EMISSION** sets the emission type for heating mode.

**ZONE2 H-EMISSION** sets the emission type for heating mode.

### 8.7 AUTO MODE SETTING Menu

**MENU > FOR SERVICEMAN > AUTO MODE SETTING**

In **AUTO MODE SETTING** the following parameters should be set.

**T4AUTOCMIN** sets the ambient temperature below which the heat pump will not provide chilled water for space cooling in auto mode. Refer to Figure 3-8.18.

**T4AUTOHMAX** sets the ambient temperature above which the heat pump will not provide heated water for space heating in auto mode. Refer to Figure 3-8.18.

Figure 3-8.17: AUTO MODE SETTING menu

4 AUTO. MODE SETTING	
4.1 T4AUTOCMIN	25°C
4.2 T4AUTOHMAX	17°C
↕ ADJUST	↔

Figure 3-8.18: T4AUTOHMAX, T4AUTOCMIN

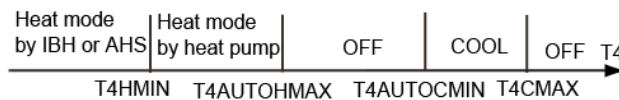

- Abbreviations:  
 HP: Heat pump  
 AHS: Additional heating source  
 IBH: Backup electric heater  
 T4CMAX: The ambient temperature above which the heat pump will not operate in cooling mode.  
 T4HMIN: The ambient temperature below which the heat pump will not operate in heating mode.

## 8.8 TEMP. TYPE SETTING Menu

MENU > FOR SERVICEMAN > TEMP. TYPE SETTING

The TEMP. TYPE SETTING is used for selecting whether the water flow temperature or room temperature is used to control the ON/OFF of the heat pump.

When ROOM TEMP. is enabled, the target water flow temperature will be calculated from climate-related curves (refer to “9.1 Climate related curves”).

For installations without room thermostats, space heating and cooling modes can be controlled in one of two different ways:

3. according to the MDV thermal leaving water temperature alone
4. according to the room temperature detected by the MDV thermal Split user interface’s built-in temperature sensor alone

**WATER FLOW TEMP.** sets whether space heating/cooling modes are controlled according to the MDV thermal leaving water temperature. If **YES** is selected, the user is able to set the MDV thermal Split unit’s leaving water temperature set temperature on the user interface’s main screen.

Figure 3-8.19: TEMP. TYPE SETTING menu

5 TEMP. TYPE SETTING	
5.1 WATER FLOW TEMP.	YES
5.2 ROOM TEMP.	NON
5.3 DOUBLE ZONE	NON
◀ ADJUST ▶	

Figure 3-8.20: Only set WATER FLOW TEMP to YES

01-01-2018	23:59	↑13°
 35 °C	ON 	 38 °C

**ROOM TEMP.** sets whether space heating/cooling modes are controlled according to the room temperature detected by the temperature sensor in the MDV thermal Split user interface. If **YES** is selected, the user is able to set the room temperature set temperature on the user interface’s main screen, no matter what is the setting of **WATER FLOW TEMP.**

Figure 3-8.21: Only set ROOM TEMP to YES

01-01-2018	23:59	↑13°
 25.0 °C	ON 	 38

**DOUBLE ZONE** sets whether there are two zones.

If set WATER FLOW TEMP. and ROOM TEMP. to YES, meanwhile set DOUBLE ZONE to NON or YES, the following pages will be displayed. In this case, the setting value of zone 1 is T1S, the setting value of zone 2 is T1S2 (The corresponding T1S2 is calculated according to the climate related curves.)

Figure 3-8.22: Set WATER FLOW TEMP. and ROOM TEMP. to YES; Set DOUBLE ZONE to NON or YES

01-01-2018	23:59	↑13°
 35 °C	ON 	 38 °C

Homepage (zone 1)

01-01-2018	23:59	↑13°
<sub>2</sub> 25.0 °C	ON 	

Addition page (zone 2)  
(Double zone is effective)

# MDV thermal Arctic Split



If set DOUBLE ZONE to YES and set ROOM TEMP. to NON, meanwhile set WATER FLOW TEMP. to YES or NON, the following pages will be displayed. In this case, the setting value of zone 1 is T1S, the setting value of zone 2 is T1S2.

Figure 3-8.23: Set DOUBLE ZONE to YES and set ROOM TEMP. to NON; Set WATER FLOW TEMP. to YES or NON

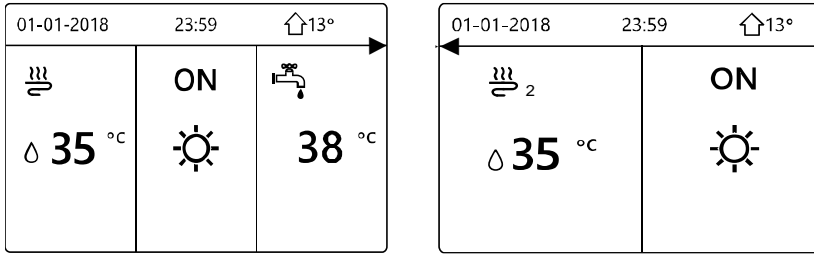

Homepage (zone 1)

Addition page (zone 2)

If set DOUBLE ZONE and ROOM TEMP. to YES, meanwhile set WATER FLOW TEMP. to YES or NON, the following page will be displayed. In this case, the setting value of zone 1 is T1S, the setting value of zone 2 is T1S2. (The corresponding T1S2 is calculated according to the climate related curves.)

Figure 3-8.24: Set DOUBLE ZONE and ROOM TEMP. to YES; Set WATER FLOW TEMP. to YES or NON

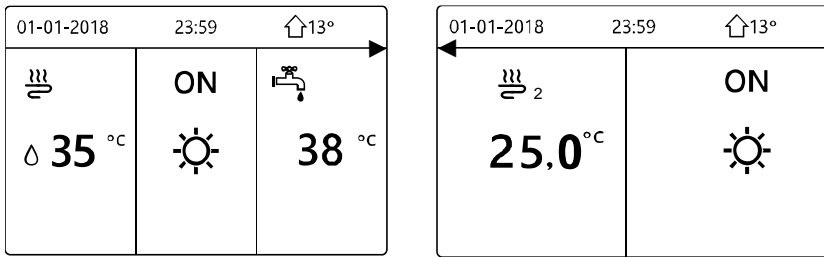

Homepage (zone 1)

Addition page (zone 2)  
(Double zone is effective)

## 8.9 ROOM THERMOSTAT Menu

### MENU > FOR SERVICEMAN > ROOM THERMOSTAT

As an alternative to controlling space heating/cooling modes according to the MDV thermal Split unit's leaving water temperature and/or the room temperature detected by the temperature sensor in the MDV thermal Split user interface, separate room thermostat can be installed and used to control space heating/cooling modes.

Figure 3-8.25: ROOM THERMOSTAT menu

6 ROOM THERMOSTAT	
6.1 ROOM THERMOSTAT	NON
ADJUST	

In **ROOM THERMOSTAT** the following parameters should be set.

**ROOM THERMOSTAT** sets whether or not room thermostats are installed. For installations with room thermostats, select **YES**. For installations without room thermostats, select **NON**.

ROOM THERMOSTAT = NON: No room thermostat.

ROOM THERMOSTAT = MODE SET: Room thermostat can control heating and cooling individually.

ROOM THERMOSTAT=ONE ZONE: Room thermostat provides the switch signal to unit.

ROOM THERMOSTAT=DOUBLE ZONE: Indoor unit is connected with two room thermostat.

## 8.10 OTHER HEATING SOURCE Menu

### 8.10.1 OTHER HEATING SOURCE menu overview

MENU > FOR SERVICEMAN > OTHER HEATING SOURCE

Figure 3-8.26: OTHER HEATING SOURCE menu

7 OTHER HEATING SOURCE 1/2	7 OTHER HEATING SOURCE 2/2
7.1 dT1_IBH_ON 5°C	7.6 T4_AHS_ON 5°C
7.2 t_IBH_DELAY 30MIN	7.7 IBH LOCATE PIPE LOOP
7.3 T4_IBH_ON -5°C	7.8 P_IBH1 0.0kW
7.4 dT1_AHS_ON 5°C	7.9 P_IBH2 0.0kW
7.5 t_AHS_DELAY 30MIN	7.10 P_TBH 2.0kW
ADJUST	ADJUST

In **OTHER HEATING SOURCE** the following parameters should be set. Backup electric heater is optional.

**dT1\_IBH\_ON** sets the temperature difference between the heat pump's leaving water set temperature (T1S) and the heat pump's leaving water temperature (T1) above which the backup electric heater heating element(s) are on. When  $T1S - T1 \geq dT1\_IBH\_ON$  the backup electric heater is on (on models where the backup electric heater has a simple on/off control function).

**t\_IBH\_DELAY** sets the delay between the compressor starting and the backup electric heater being turned on.

**T4\_IBH\_ON** sets the ambient temperature below which the backup electric heater is used. If the ambient temperature is above **T4\_IBH\_ON**, the backup electric heater is not used. The relationship between operation of the backup heater and the ambient is shown in Figure 3-8.27.

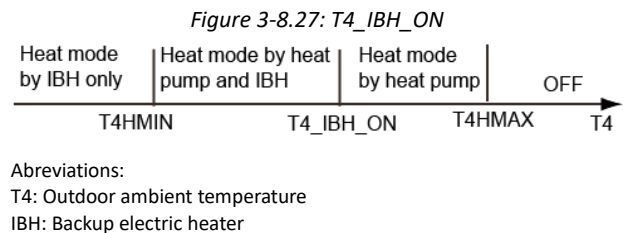

**dT1\_ASH\_ON** sets the temperature difference between the heat pump's leaving water set temperature (T1S) and the heat pump's leaving water temperature (T1) above which the additional heating source is on. When  $T1S - T1 \geq dT1\_ASH\_ON$  the additional heating source is on.

**t\_ASH\_DELAY** sets the delay between the compressor starting and the additional heating source being turned on.

**T4\_AHS\_ON** sets the ambient temperature below which the additional heating source is used. If the ambient temperature is above **T4\_AHS\_ON**, the additional heating source is not used. The relationship between operation of the additional heating source and the ambient is shown in the picture below.

Figure 3-8.28: T4\_AHS\_ON

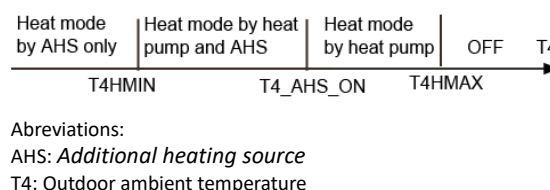

**IBH LOCATE** means IBH is installed for pipe heating.

**P\_IBH1**, **P\_IBH2** set heating capacity of IBH and **P\_TBH** sets heating capacity of TBH, which are used for energy consumption statistics.

### 8.11 HOLIDAY AWAY SETTING Menu

MENU > FOR SERVICEMAN > HOLIDAY AWAY SETTING

The **HOLIDAY AWAY SETTING** menu settings are used to set the outlet water temperature to prevent water pipes freezing when away from home in cold weather seasons. In **HOLIDAY AWAY SETTING** the following parameters should be set.

**T1S\_H.A.\_H** sets the heat pump’s leaving water set temperature for space heating mode when in holiday away mode.

**T5S\_H.A.\_DHW** sets the heat pump’s leaving water set temperature for DHW mode when in holiday away mode.

Figure 3-8.29: HOLIDAY AWAY SETTING menu

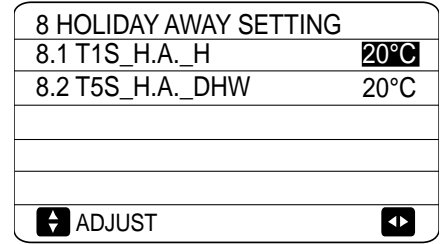

### 8.12 SERVICE CALL Menu

MENU > FOR SERVICEMAN > SERVICE CALL

In **SERVICE CALL** the following parameters can be set.

**PHONE NO.** and **MOBILE NO.** can be used to set after-sales service contact numbers. If set, these numbers are displayed to users in **MENU > FOR SERVICEMAN > SERVICE CALL**

Use ▼ ▲ to adjust the numerical values. The maximum length of the phone numbers is 14 digits.

Figure 3-8.30: SERVICE CALL menu

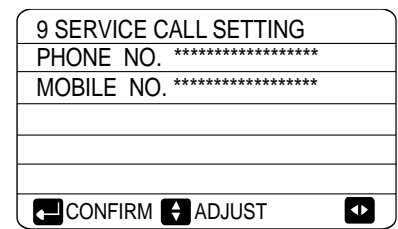

The black rectangle found between 0 and 9 when scrolling up and down using ▼ ▲ is converted to a blank space when the phone numbers are displayed to users in **MENU > FOR SERVICEMAN > SERVICE CALL** and can be used for phone numbers less than 14 digits in length.

### 8.13 RESTORE FACTORY SETTINGS

MENU > FOR SERVICEMAN > RESTORE FACTORY SETTINGS

**RESTORE FACTORY SETTINGS** is used to restore all the parameters set in the user interface to their factory defaults.

On selecting **YES**, the process of restoring all settings to their factory defaults begins and progress is displayed as a percentage.

Figure 3-8.31: RESTORE FACTORY SETTINGS screens

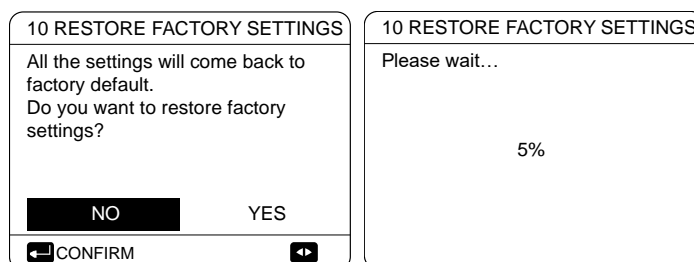

## 8.14 TEST RUN

### 8.14.1 TEST RUN Menu overview

**MENU > FOR SERVICEMAN > TEST RUN**

**TEST RUN** is used to check that the valves, air purge function, circulation pump, space cooling mode, space heating mode and DHW mode are all operating correctly.

Figure 3-8.32: TEST RUN start screen and TEST RUN menu

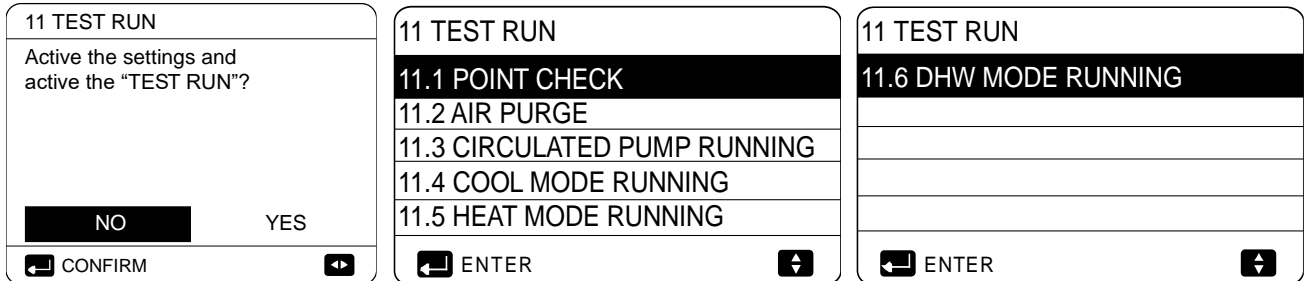

During test run, all buttons except OK are invalid. If you want to turn off the test run, please press OK. For example, when the unit is in air purge mode, after you press OK, the following page will be displayed:

Figure 3-8.33: Exit air purge screen

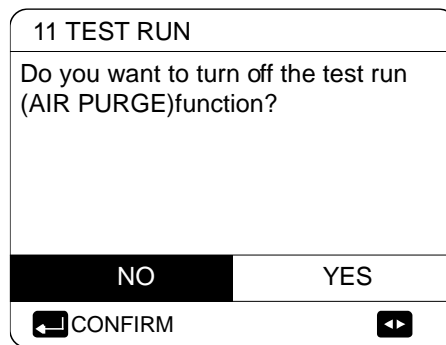

### 8.14.2 POINT CHECK menu

**MENU > FOR SERVICEMAN > TEST RUN > POINT CHECK**

The **POINT CHECK** menu is used to check the operation of individual components. Use ▼▲ to scroll to the components you want to check and press ON/OFF to toggle the on/off state of the component. If a valve does not turn on/off when its on/off state is toggled or if a pump/heater does not operate when turned on, check the component's connection to the hydronic system main PCB.

Figure 3-8.34: POINT CHECK menu

11 TEST RUN	1/2	11 TEST RUN	2/2
3WAY-VALVE 1	OFF	PUMPSOLAR	OFF
3WAY-VALVE 2	OFF	PUMPDHW	OFF
PUMP_I	OFF	INNER BACKUP HEATER	OFF
PUMP_O	OFF	TANK HEATER	OFF
PUMP_C	OFF	3-WAY VALVE 3	OFF
ON/OFF	↕	ON/OFF	↕

## 8.14.3 AIR PURGE operation

**MENU > FOR SERVICEMAN > TEST RUN > AIR PURGE**

Once installation is complete it is important to run the air purge function to remove any air which may be present in the water piping and which could cause malfunctions during operation.

The **AIR PURGE** operation is used to remove air from the water piping. Before running AIR PURGE mode, make sure that the air purge valve is open. When the air purge operation starts, the 3-way valve opens and the 2-way valve closes. 60 secs later the pump in the unit (PUMPI) operates for 10min during which the flow switch does not work. After the pump stops, the 3-way valve closes and the 2-way valve opens. 60 secs later both PUMPI and PUMPO operate until the next command is received. If any error code is displayed during the air purge operation, the cause should be investigated. Refer to Part 3, 9.2 "Error Code table".

Figure 3-8.35: AIR PURGE operation

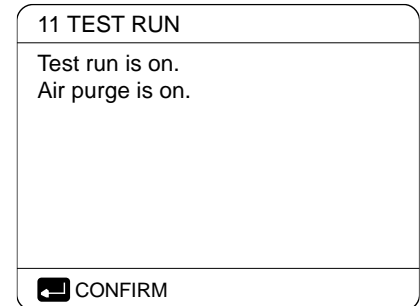

## 8.14.4 CIRCULATION PUMP RUNNING operation

**MENU > FOR SERVICEMAN > TEST RUN > CIRCULATION PUMP RUNNING**

The **CIRCULATION PUMP RUNNING** operation is used to check the operation of the circulation pump. When the circulation pump running operation starts, all running components stop. 60 secs later, the 3-way valve opens and the 2-way valve closes. After a further 60 secs PUMPI starts. 30 seconds later, if the flow switch detects that the water flow is normal, PUMPI operates for 3 min. After the pump stops 60s, the 3-way valve closes and the 2-way valve opens. 60s later both PUMI and PUMPO will operate. After a further 2 min the flow switch start to check the water flow. If the water flow rate is sufficient, both PUMPI and PUMPO operate until the next command is received. If the water flow rate is insufficient over any 15-second period, PUMPI and PUMPO stop and error code E8 is displayed. Refer to Part 3, 8.2 "Error Code table".

Figure 3-8.36: CIRCULATION PUMP RUNNING display

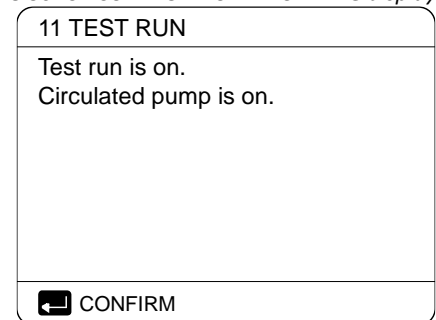

## 8.14.5 COOL MODE RUNNING operation

**MENU > FOR SERVICEMAN > TEST RUN > COOL MODE RUNNING**

The **COOL MODE RUNNING** operation is used to check the operation of the system in space cooling mode.

During the **COOL MODE RUNNING** operation, the MDV thermal Split unit leaving water set temperature is 7°C. The current actual leaving water temperature is displayed on the user interface. The unit operates until the leaving water temperature drops to the set temperature or the next command is received.

Figure 3-8.37: COOL MODE RUNNING display

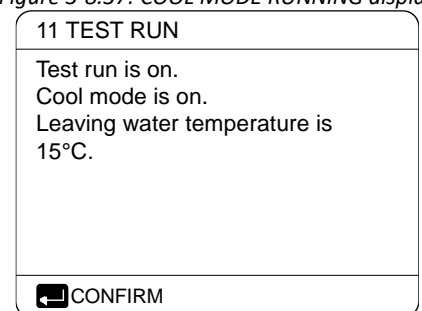

If any error code is displayed during the cool mode running operation, the cause should be investigated. Refer to Part 3, 8.2 "Error Code table".

## 8.14.6 HEAT MODE RUNNING operation

The **HEAT MODE RUNNING** operation is used to check the operation of the system in space heating mode.

During the **HEAT MODE RUNNING** operation the MDV thermal Split unit leaving water set temperature is 35°C. The current actual leaving water temperature is displayed on the user interface. When the **HEAT MODE RUNNING** operation starts, the heat pump first runs for 10 mins.

After 10 mins:

5. On systems where an auxiliary heat source (AHS) is installed, the AHS starts and runs for 10 mins (whilst the heat pump continues running), after which the AHS stops and the heat pump continues to operate until the water temperature rises to the set temperature or the heat mode running operation is excited by pressing **OK**.
6. On systems where a backup electric heater is being used, the backup heater turn on (on models where the backup heater has a simple on/off control function). 3 mins later the backup electric heater will turn off. The heat pump will then operate until the water temperature rises to the set temperature or the **next command is received**.
7. On systems with no auxiliary heat source (AHS), the heat pump will then operate until the water temperature rises to the set temperature or the **next command is received**.

If any error code is displayed during the cool mode running operation, the cause should be investigated. Refer to Part 3, 8.2 "Error Code table".

## 8.14.7 DHW MODE RUNNING operation

The **DHW MODE RUNNING** operation is used to check the operation of the system in DHW mode.

During the **DHW MODE RUNNING** operation, the DHW set temperature is 55°C. On systems where a tank boost heater is installed, the tank boost heater will turn on once the heat pump has run for 10 mins. The tank boost heater will turn off 3 min later and the heat pump will operate until the water temperature rises to the set temperature or the **next command is received**.

Figure 3-8.38: HEAT MODE RUNNING display

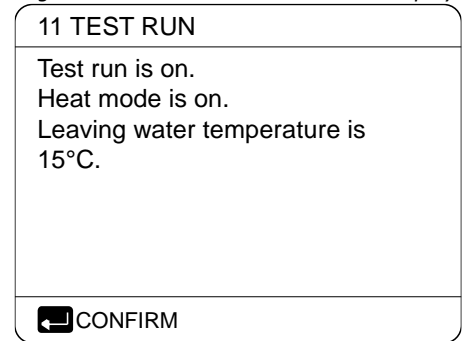
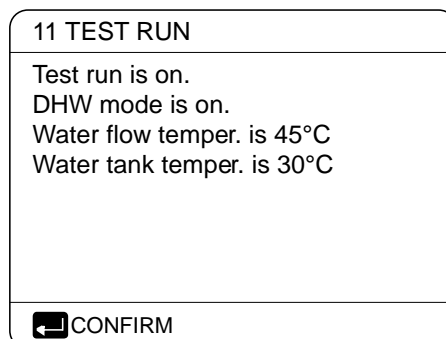

Figure 3-8.39: DHW MODE RUNNING display





# MDV thermal Arctic Split



## 8.15 SPECIAL FUNCTION

### 8.15.1 SPECIAL FUNCTION menu overview

**MENU > FOR SERVICEMAN > SPECIAL FUNCTION**

**SPECIAL FUNCTION** is used to pre-heating floor and drying up floor once installation is complete or the first time start up the unit or restart the unit after a long time stop.

Figure 3-8.40: Special functions menu

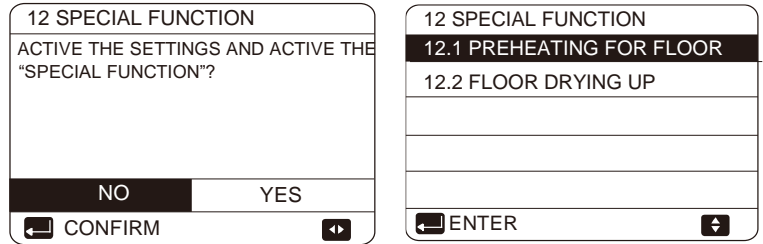

### 8.15.2 PREHEATING FOR FLOOR

**MENU > FOR SERVICEMAN > SPECIAL FUNCTION > PREHEATING FOR FLOOR**

Before floor heating, if a large amount of water remains on the floor, the floor may be warped or even rupture during floor heating operation, in order to protect the floor, floor drying is necessary, during which the temperature of the floor should be increased gradually.

During first operation of the unit, air may remain in the water system which can cause malfunctions during operation. It is necessary to run the air purge function to release the air (make sure the air purge valve is open).

**T1S** sets the heat pump's leaving water set temperature in preheating for floor mode.

**t\_fristFH** sets the duration of preheating for floor mode.

The operation of the unit during preheating for floor mode is illustrated in Figure 3-8.42.

Figure 3-8.41: Preheating for floor menu

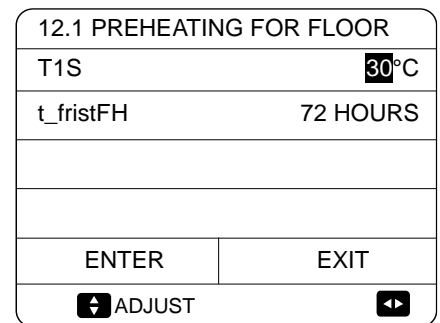
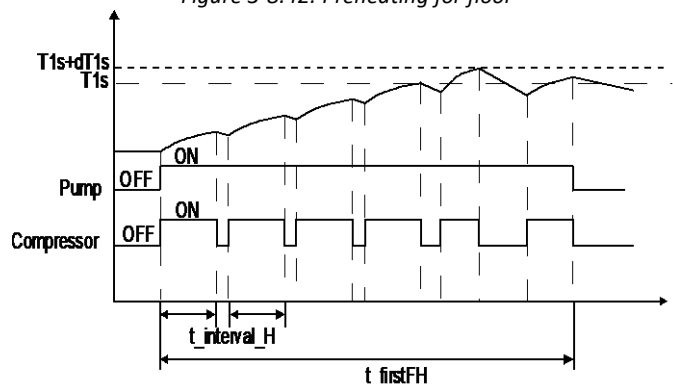

Figure 3-8.42: Preheating for floor



Abbreviations:  
 t\_interval\_H: Compressor re-start delay in space heating mode. (Refer to Part 3, 8.6 "HEAT MODE SETTING Menu").

Whilst the preheating for floor operation is running, the number of minutes that it has been running for and the heat pump's leaving water temperature are displayed on the user interface. During the preheating for floor operation all buttons except **OK** are inactivated. To exit the preheating for floor operation, press **OK** and then select **YES** when prompted. Refer to Figure 3-8.43.

Figure 3-8.43: Preheating for floor screens

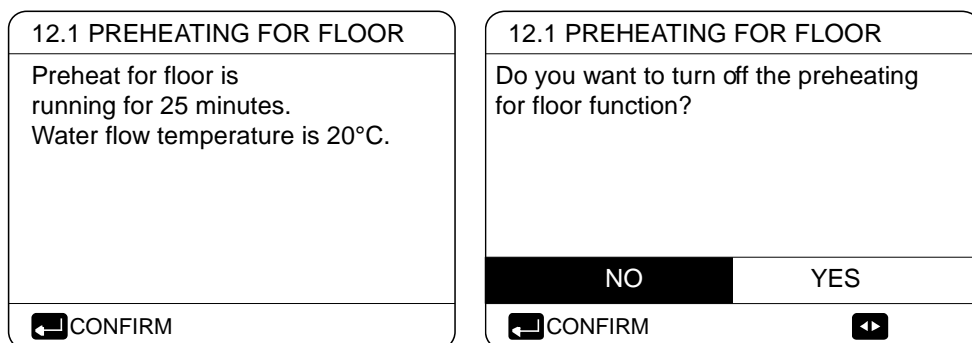

### 8.15.3 FLOOR DRYING UP

**MENU > FOR SERVICEMAN > SPECIAL FUNCTION > FLOOR DRYING UP**

Figure 3-8.44: FLOOR DRYING UP menu

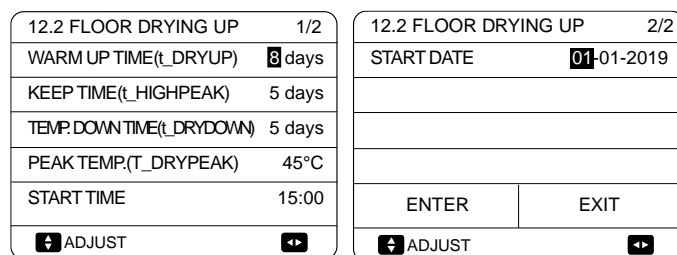

For newly-installed under-floor heating systems, floor drying up mode can be used to remove moisture from the floor slab and subfloor to prevent warping or rupture of the floor during floor heating operation. There are three phases to the floor drying up operation:

8. Phase 1: gradual temperature increase from a starting point of 25°C to the peak temperature
9. Phase 2: maintain peak temperature
10. Phase 3: gradual temperature decrease from the peak temperature to 45°C

**WARM UP TIME(t\_DRYUP)** sets the duration of Phase 1.

**KEEP TIME(t\_HIGHPEAK)** sets the duration of Phase 2.

**TEMP. DOWN TIME(t\_DRYDOWN)** is the duration of Phase 3.

**PEAK TEMP(T\_DRYPEAK)** sets the heat pump's leaving water set temperature for Phase 2.

**START TIME** sets the floor drying up operation start time.

**START DATE** sets the floor drying up operation start date.

The heat pump's leaving water set temperature during the floor drying up operation is illustrated in Figure 3-8.45.

Figure 3-8.45: FLOOR DRYING UP settings

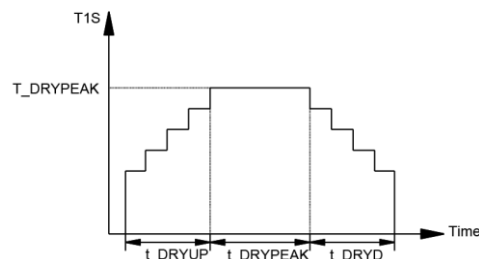

During the floor drying up operation all buttons except **OK** are inactivated. To exit the floor drying up operation, press **OK** and then select **YES** when prompted.

Figure 3-8.46: FLOOR DRYING UP screen

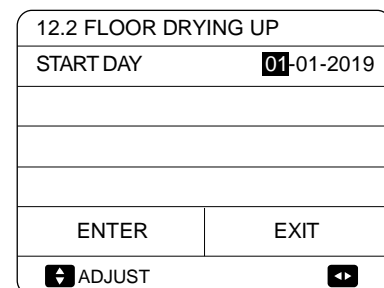

Note: In the event of a heat pump malfunction, floor drying up mode will continue if a backup electric heater and/or additional heating source is available and configured to support space heating mode.

# MDV thermal Arctic Split



## 8.16 AUTO RESTART

MENU > FOR SERVICEMAN > AUTO RESTART

**AUTO RESTART** sets whether or not the unit re-applies the user interface settings when the power returns following a power failure. Select **YES** to enable auto restart or **NON** to disable auto restart.

If the auto restart function is enabled, when the power returns following a power failure, the unit re-applies the user interface settings from before the power failure. If the auto restart function is disabled, when the power returns after a power failure, the unit won't auto restart.

Figure 3-8.47: AUTO RESTART menu

13 AUTO RESTART	
13.1 COOL/HEAT MODE	<b>YES</b>
13.2 DHW MODE	NON
ADJUST	

## 8.17 POWER INPUT LIMITATION

MENU > FOR SERVICEMAN > POWER INPUT LIMITATION

**POWER INPUT LIMITATION** sets the type of power input limitation and the setting range is 0-8. If the unit will operate at larger power input, 0 should be selected. If the unit will operate at a lower power input, 1-8 should be selected and the power input and capacity will decrease.

Figure 3-8.48: POWER INPUT LIMITATION menu

14 POWER INPUT LIMITATION	
14.1 POWER INPUT LIMITATION	<b>0</b>
ADJUST	

Figure 3-8.49: Limitation value (unit:A)

Model \ No.	0	1	2	3	4	5	6	7	8
4/6kW	18	18	16	15	14	13	12	12	12
8/10kW	19	19	18	16	14	12	12	12	12
12/14kW(1N)	30	30	28	26	24	22	20	18	16
16kW(1N)	30	30	29	27	25	23	21	19	17
12/14kW(3N)	14	14	13	12	11	10	9	9	9
16kW(3N)	14	14	13	12	11	10	9	9	9

## 8.18 INPUT DEFINE

MENU > FOR SERVICEMAN > INPUT DEFINE

Figure 3-8.50: INPUT DEFINE

15 INPUT DEFINE	
15.1 M1M2	<b>REMOTE</b>
15.2 SMART GRID	NON
15.3 Tw2	NON
15.4 Tbt1	NON
15.5 Tbt2	NON
ADJUST	

15 INPUT DEFINE	
15.6 Ta	HMI
15.7 Ta-adj	-2°C
15.8 SOLAR INPUT	NON
15.9 F-PIPE LENGTH	<10m
15.10 RT/Ta_PCB	NON
ADJUST	

15 INPUT DEFINE	
15.11 PUMP_I SILENT MODE	NON
15.12 DFT1/DFT2	DEFROST
ADJUST	

**INPUT DEFINE** sets sensors and functions to fulfill with installation.

**M1M2** sets the control function of M1M2 for remote ON/OFF of unit or AHS or TBH

**SMART GRID** sets whether SMART GRID control signal is connected to hydronic PCB.

**Tw2** sets whether T1b sensor exist in the installation.

**Tbt1** set whether balance tank temperature sensors are installed in the balance tank. (Tbt1 sensor, individually purchase;Tbt2, reserved)

**Ta** sets the Ta sensor connection type (HMI: Ta on wired controller; IDU: Ta connected on hydronic PCB)

**Ta-adj** is a correction value for Ta.

**SOLAR INPUT** sets whether solar control signal is connected to hydronic PCB. (0=NON; 1=CN18; Tsolar 2=CN11SL1SL2)

**F-PIPE LENGTH** sets the length of refrigerant pipes between outdoor unit and indoor unit.

**RT/Ta\_PCB** sets whether M-kit is valid.

**Pump silent mode** can decrease water pump maximum output by 5% in order to decrease the noise of heat pump.

**DFT1/DFT2** sets DFT1 and DFT2 port of the hydro module as DEFROST or Alarm(ALARM function can be valid only with IDU software version higher than V99)

## 8.19 HMI ADDRESS SET

**MENU > FOR SERVICEMAN > HMI ADDRESS SET**

Figure 3-8.52: HMI ADDRESS SET

17 HMI ADDRESS SET	
17.1 HMI SET	MASTER
17.2 HMI ADDRESS FOR BMS	1
17.3 STOP BIT	1

**HMI SET** sets the wired controller is master or slave. (0=MASTER, 1=SLAVE)

When HMI SET is set to SLAVE, the controller can only switch the operation mode, turn on or off, set the temperature, and cannot set other parameters and functions.

**HMI ADDRESS FOR BMS** sets the HMI address code for BMS.(only valid for master controller)

The **STOP BIT** of wired controller and upper computer software should be the same to ensure the reliability of data transformation.

## 9 Operation parameter

### MENU > OPERATION PARAMETER

This menu is for installer or service engineer reviewing the operation parameters. There are nine pages for the operating parameter as following

Figure 3-9.1: Operation parameter

OPERATION PARAMETER	#01
ONLINE UNITS NUMBER	1
OPERATE MODE	COOL
SV1 STATE	ON
SV2 STATE	OFF
SV3 STATE	OFF
PUMP_I	ON
ADDRESS	1/9

OPERATION PARAMETER	#01
PUMP-O	OFF
PUMP-C	OFF
PUMP-S	OFF
PUMP-D	OFF
PIPE BACKUP HEATER	OFF
TANK BACKUP HEATER	ON
ADDRESS	2/9

OPERATION PARAMETER	#01
GAS BOILER	OFF
T1 LEAVING WATER TEMP.	35°C
WATER FLOW	1.72m <sup>3</sup> /h
HEAT PUMP CAPACTIY	11.52kW
POWER CONSUM.	1000kWh
Ta ROOM TEMP	25°C
ADDRESS	3/9

OPERATION PARAMETER	#01
T5 WATER TANK TEMP.	53°C
Tw2 CIRCUIT2 WATER TEMP.	35°C
TIS' C1 CLIMATE CURVE TEMP.	35°C
TIS2' C2 CLIMATE CURVE TEMP.	35°C
TW_O PLATE W-OUTLET TEMP.	35°C
TW_I PLATE W-OUTLET TEMP.	30°C
ADDRESS	4/9

OPERATION PARAMETER	#01
Tbt1 BUFFERTANK_UP TEMP.	35°C
Tbt2 BUFFERTANK_LOW TEMP.	35°C
Tsolar	25°C
IDU SOFTWARE	01-09-2019V01
ADDRESS	5/9

OPERATION PARAMETER	#01
ODU MODEL	6kW
COMP.CURRENT	12A
COMP.FREQUENCY	24Hz
COMP.RUN TIME	54 MIN
COMP.TOTAL RUN TIME	1000Hrs
EXPANSION VALVE	200P
ADDRESS	6/9

OPERATION PARAMETER	#01
FAN SPEED	600R/MIN
IDU TARGET FREQUENCY	46Hz
FREQUENCY LIMITED TYPE	5
SUPPLY VOLTAGE	230V
DC GENERATRIX VOLTAGE	420V
DC GENERATRIX CURRENT	18A
ADDRESS	7/9

OPERATION PARAMETER	#01
TW_O PLATE W-OUTLET TEMP.	35°C
TW_I PLATE W-INLET TEMP.	30°C
T2 PLATE F-OUT TEMP.	35°C
T2B PLATE F-IN TEMP.	35°C
Th COMP. SUCTION TEMP.	5°C
Tp COMP. DISCHARGE TEMP.	75°C
ADDRESS	8/9

OPERATION PARAMETER	#01
T3 OUTDOOR EXCHANGE TEMP.	5°C
T4 OUTDOOR AIR TEMP.	5°C
TF MODULE TEMP.	55°C
P1 COMP. PRESSURE	2300kPa
ODU SOFTWARE	01-09-2018V01
HMI SOFTWARE	01-09-2018V01
ADDRESS	9/9

## 10 Network Configuration Guidelines

The wired controller realizes intelligent control with a built-in WIFI module, which receives control signal from the APP. Before connecting the WLAN, please check for it if the router in your environment is active and make sure that the wired controller is well-connected to the wireless signal. When the product is connected to the network, please make sure that the phone is as close as possible to the product. Midea only supports 2.4GHz band routers at present. Special characters (punctuation, spaces, etc.) are not recommended as part of the WLAN name. It is recommended that you connect no more than 10 devices to a single router lest home appliances are affected by weak or unstable network signal. If the password of the router or WLAN is changed, clear all settings and reset the appliance. APP interface changes from time to time as APP is updated and may change slightly vary from those in this document.

### 10.1 Install APP

Scan the following QR code or research "Comfort Home" in APP STORE or GOOGLE PLAY to install the APP.



### 10.2 Sign in

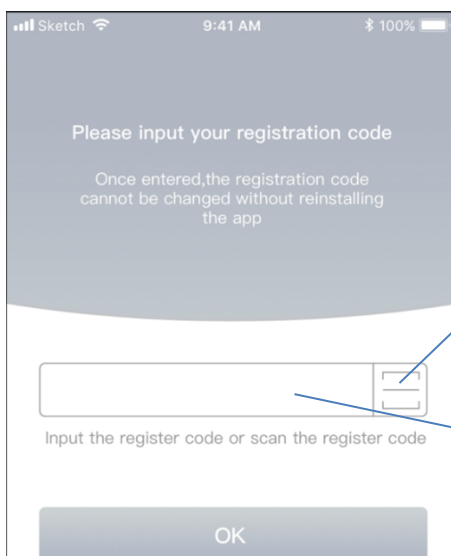

How to take the next step?

Method 1:

Scan the register QR code\*, the register code appears and enter to the SIGN IN interface automatically.

\*Note:

The register QR code location is to be selected by the customer before the heat pump product is ordered. Please scan the QR code from the respective location.

Method 2:

Input the register code and press OK.

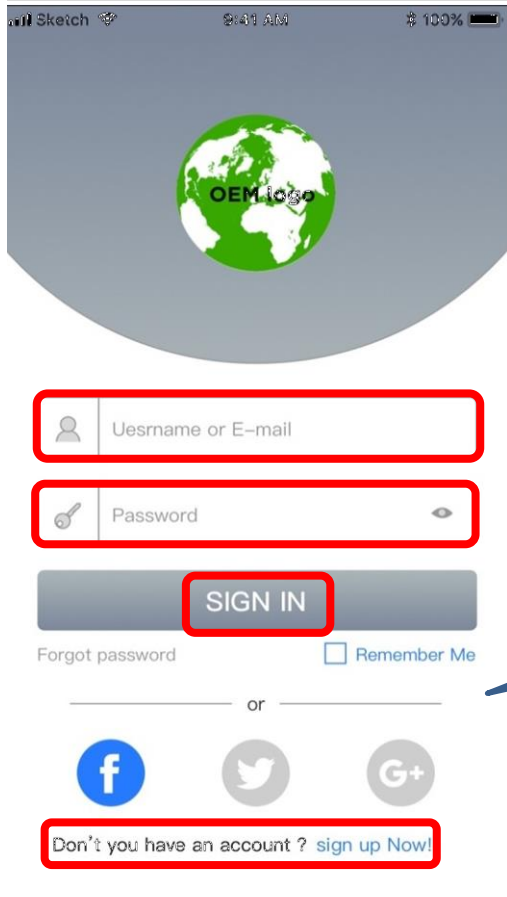

Click on Sign IN or create a new account if you have never created an account of Comfort Home before . If you have already created an account before, login with the email and password

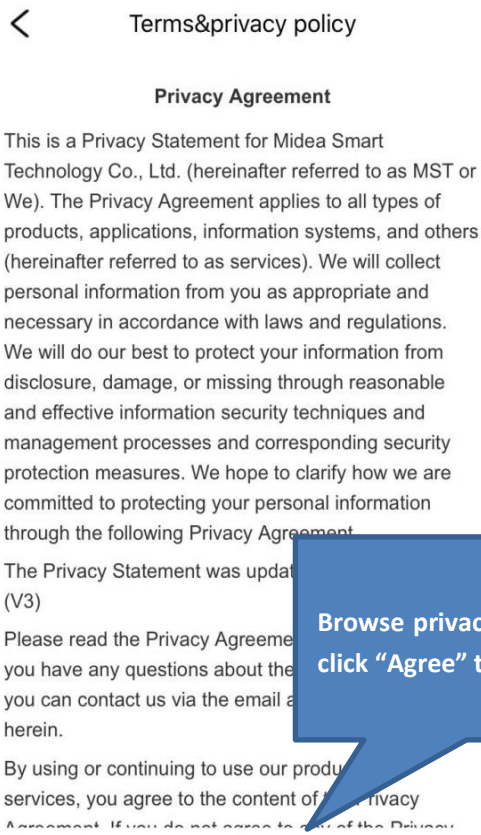
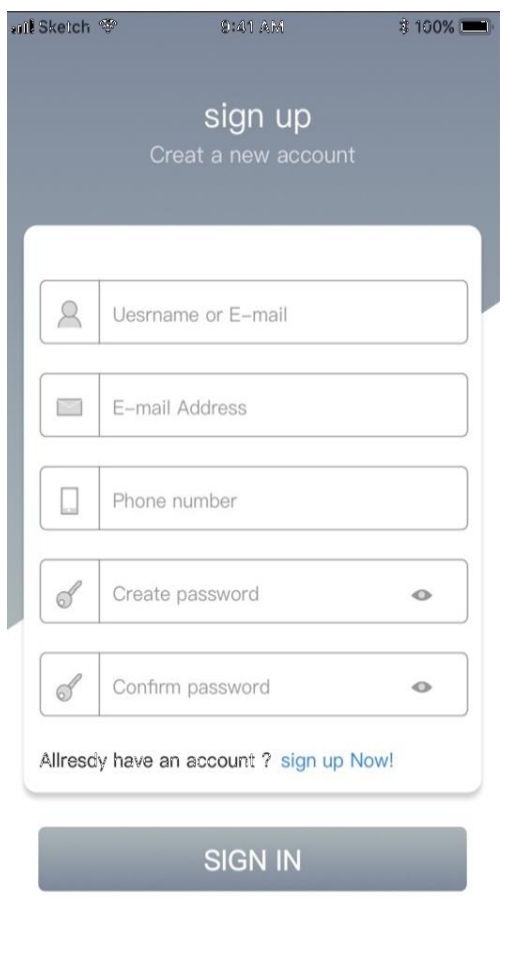

Browse privacy agreement and click "Agree" to enter next step

## 10.3 Add device and login to home Wi-Fi

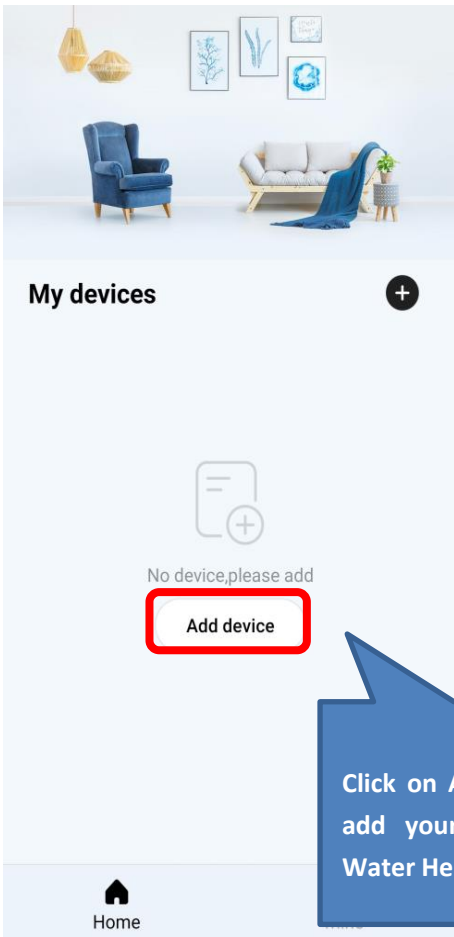

Click on Add Device to add your Heat Pump Water Heater

### Getting Started

Let's connect your appliances to your Wi-Fi network. Throughout the process, make sure:

- You are standing by your appliance
- Keep your Wi-Fi network connected.
- You have your network password.
- Only 2.4GHz network is supported by this product

This page would be displayed. Click on "Ready". You must have the password of the Wi-Fi

Got it

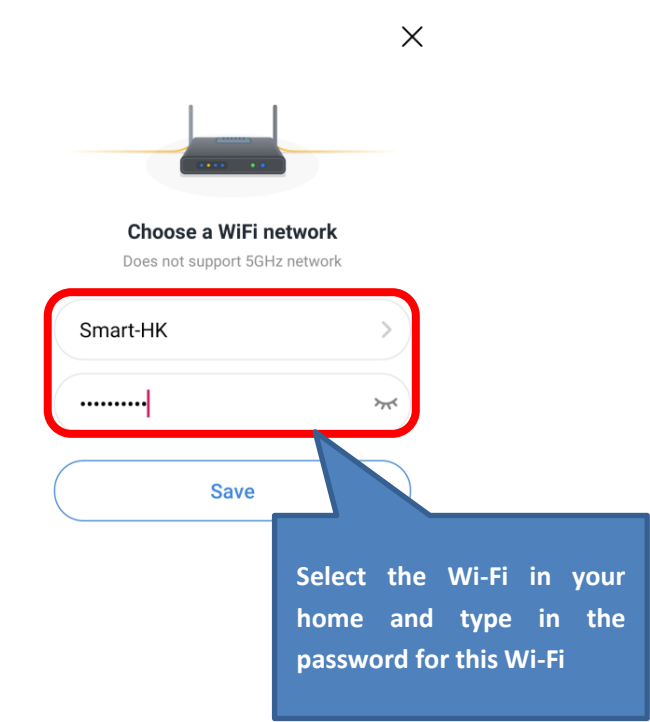

Select the Wi-Fi in your home and type in the password for this Wi-Fi

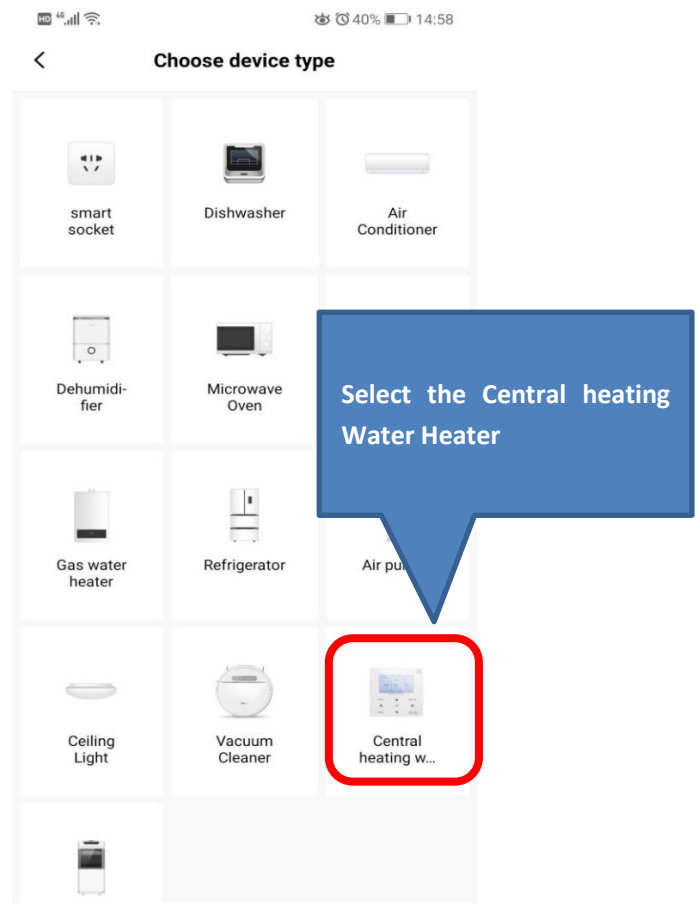

Select the Central heating Water Heater



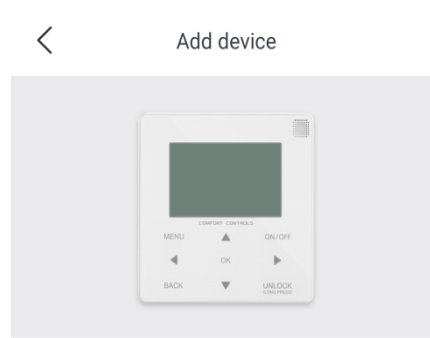
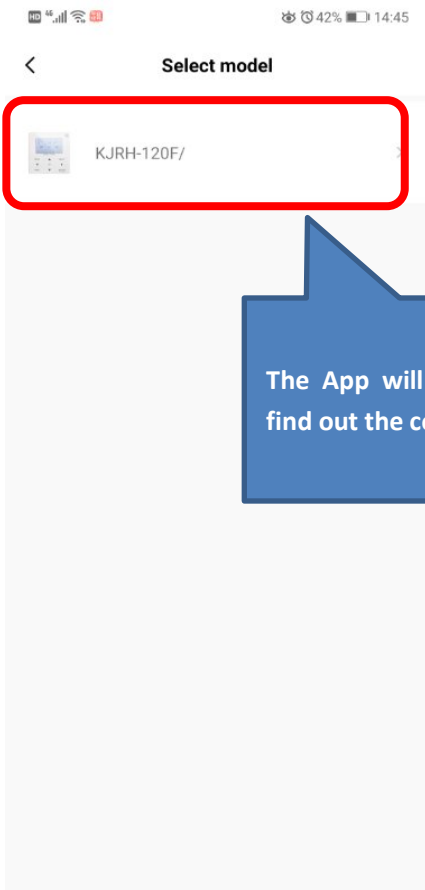

Please complete the operation in %@ seconds.  
 Click the "MENU" button on the wired controller, select "WLAN SETTING" and click the "OK" button.  
 Select "AP mode" and click the "OK" button.  
 Click the right direction button on the wired controller, then click the "OK" button to enter the AP mode. The "WIFI" icon will flash.

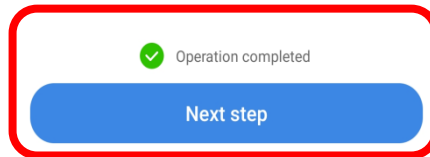
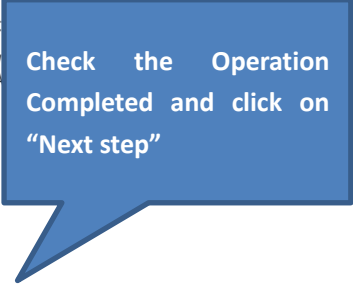

**10.4 Wired Controller Setting**

Go to "MENU"> "WLAN SETTING"> "AP MODE". Press "OK" to activate the WLAN, refer to Figure 3-8.1. Select **YES**, press **OK** to select AP mode. Select **AP Mode** correspondingly on the mobile device and continue the follow-up settings according to the APP prompts. During the Wireless distribution process, the LCD icon "Wi-Fi" flashes to indicate that the network is being deployed. After the process is completed, the icon "Wi-Fi" will be constantly on.

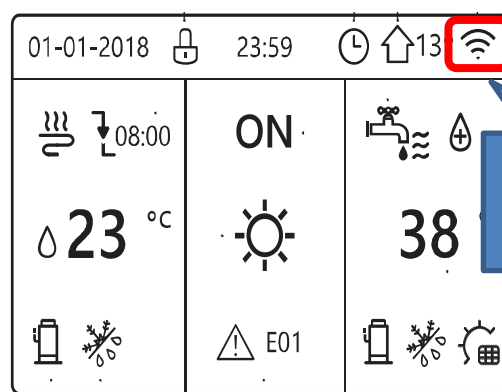
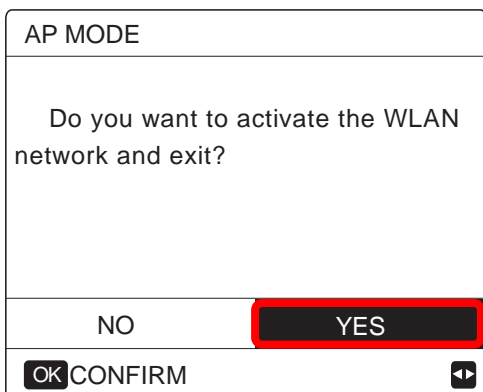
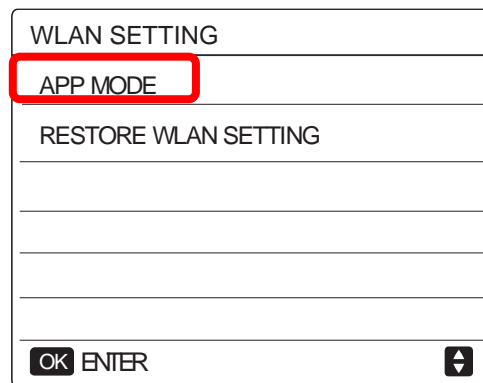
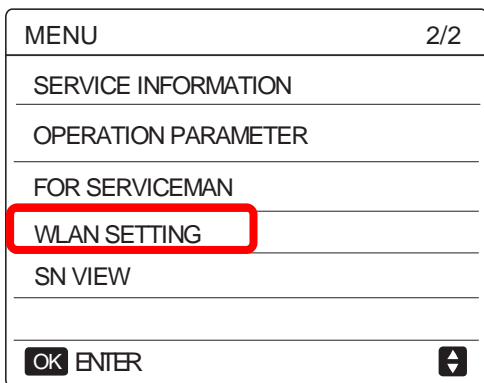

## 10.4.1 Connect to new Wi-Fi

Connect electrical appliances Cancel



1 Please select the following Wi-Fi:  
Wi-Fi: net\_xxx  
Password: 12345678

2 After the connection is successful, click on the Home Page

Once the connection starts, the app will ask you to connect your phone with another Wi-Fi: net\_xxx

Click here and connect your phone with the new Wi-Fi

Please keep the device as close as possible to the WiFi router

Networking preparation

Device networking

Bind on account

It will take some time for the app to finish up

Set up WiFi



**Connect Successfully**

The M-thermal heat pump water heater has been successfully added

M-thermal heat pump water heater

Sure

Click on "Sure", once the Account binding is finished

## 10.4.2 Finishing up

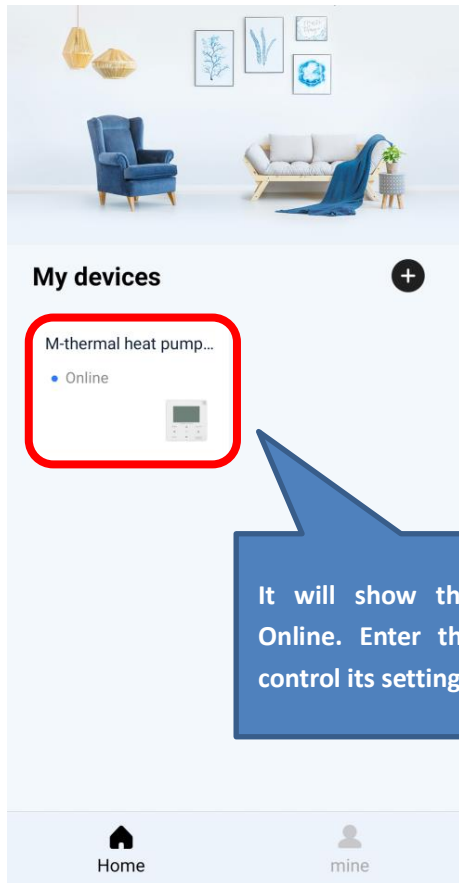

Comfort Home APP User interface

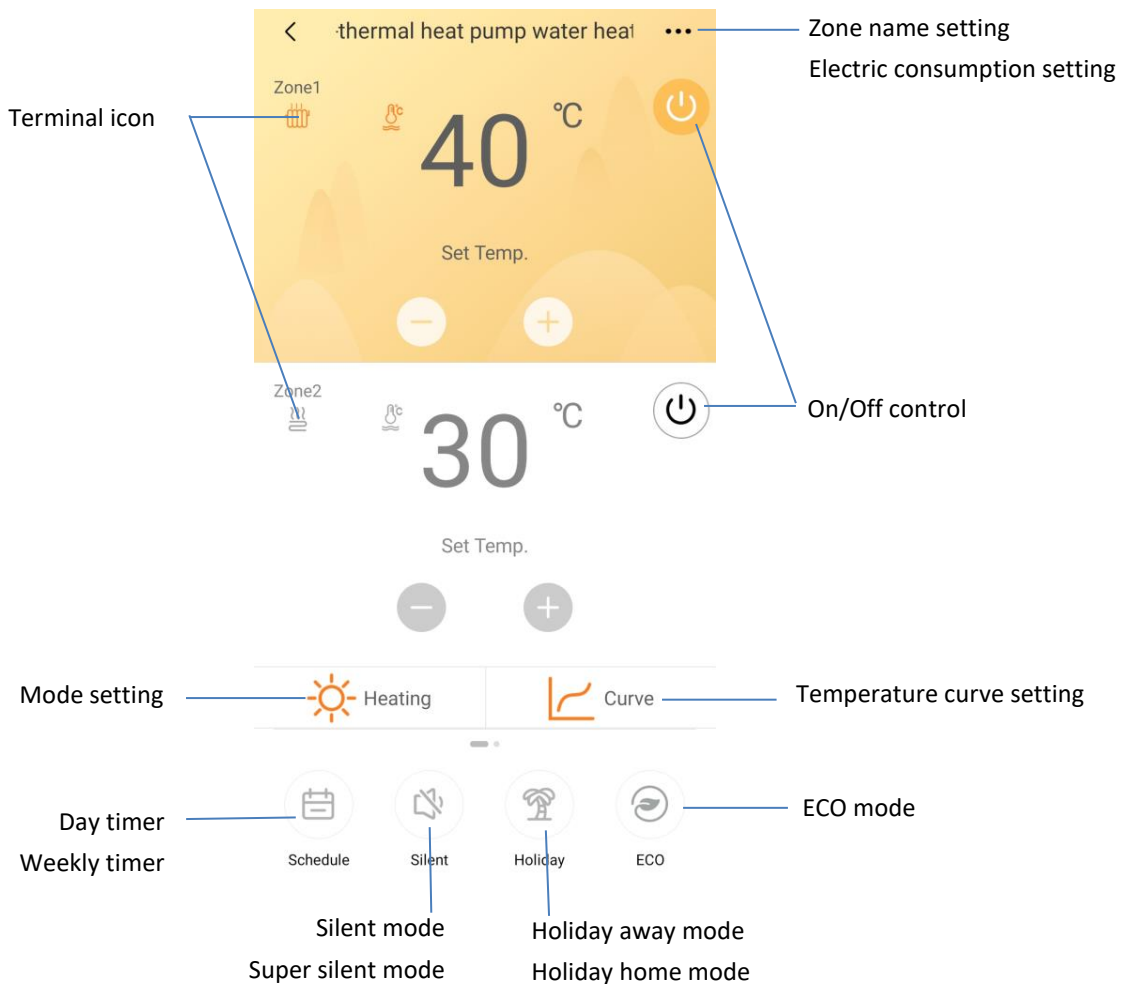

## 11 USB Function Guidelines

### 11.1 Parameters setting transfer between wired controllers

Installer can quickly copy the wired controller parameter settings from unit A to unit B via USB disk, which save the time of on-site installation. Steps are as follows:

Step 1:

Plug U disk into the port of hydronic PCB of A unit.

“USB” appears on digital display

Wired controller interface automatically changes

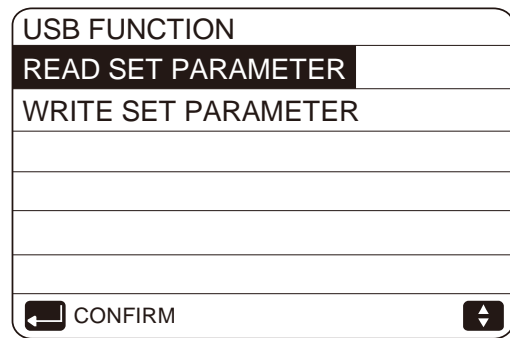
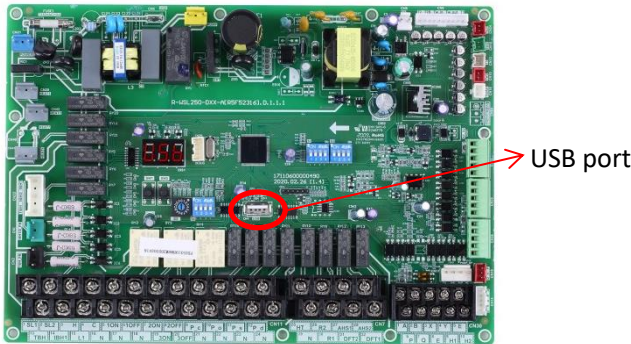

Step 2:

Select “READ SET PARAMETER” and press “OK” button then rate of progress will appear. When the process is finished, “SUCCESS” appears below and an EXCEL file which can not be seen in the wired controller interface but users can find it on computer will be generated inside the USB disk.

Select “READ SET PARAMETER”

Finished

EXCEL generated

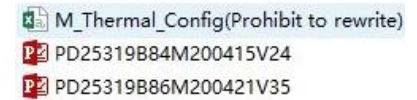
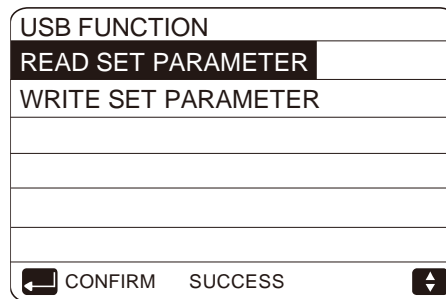
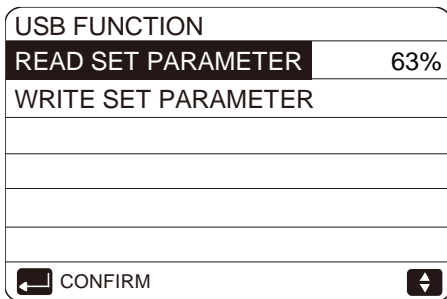

After that, if parameter correction is needed, please connect the USB with computer and open the EXCEL file to change parameters and then save it. Please do not change the file name or format. Parameters are not allowed for non-professionals to change and Midea recommends to use the wired controller to change the parameters.

Step 3:

Plug USB disk into the port of hydronic PCB of B unit and select “WRITE SET PARAMETER” then rate of progress will appear. When the process is finished, “SUCCESS” appears below.

Select “WRITE SET PARAMETER”

Finished

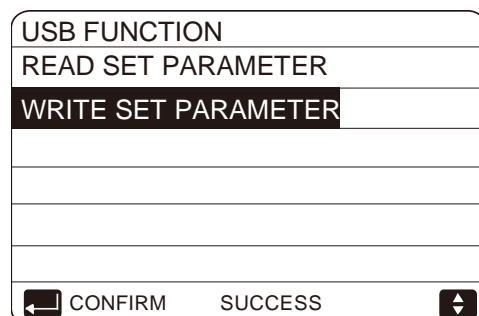
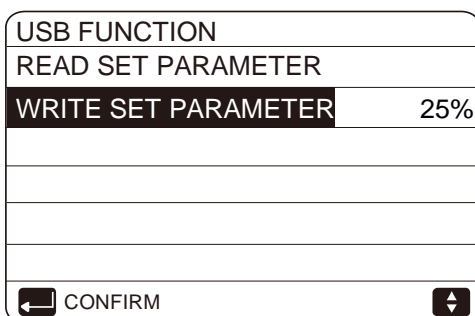

## 11.2 Convenient program upgrade for unit

There is no need to carry any heavy equipment but only USB disk can realize program upgrade. Steps are as follows:

Step 1:

Copy new program in U disk root directory where other files in bin format are not allowed in

Step 2:

Power on and make sure communication is normal.

Step 3:

Plug U disk into the port of hydronic PCB.

“USB” appears on digital display

Wired controller interface automatically changes

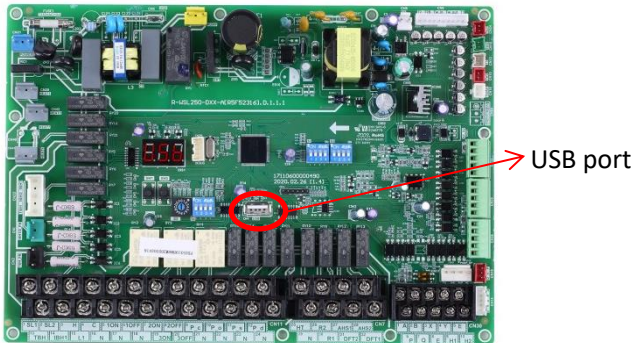

USB FUNCTION
RATED SET PARAMETER
WRITE SET PARAMETER
PD25319B84M200415V24.bin
PD25319B86M200415V24.bin
CONFIRM

Step 4:

Please distinguish between programs for main control PCB and hydronic PCB. Select one of them and press “OK” button then rate of progress appears. When the process is finished, “SUCCESS” appears below. For upgrading outdoor unit, the process normally lasts for several minutes while only few seconds is needed for indoor unit.

Select program

USB FUNCTION
RATED SET PARAMETER
WRITE SET PARAMETER
PD25319B84M200415V24.bin 51%
PD25319B86M200415V24.bin
CONFIRM

Finished

USB FUNCTION
RATED SET PARAMETER
WRITE SET PARAMETER
PD25319B84M200415V24.bin
PD25319B86M200415V24.bin
CONFIRM

Step 5:

Pull out U disk and power on again to finish upgrading program. Check the program version to make sure upgrade is successful.

Check IDU software version

OPERATION PARAMETER	#00
Tbt1 BUFFERTANK_UP TEMP.	XX °C
Tbt2 BUFFERTANK_LOW TEMP.	XX °C
Tsolar	XX °C
IDU SOFTWARE	XX-XX-XXXXXXX
ADDRESS	5/9

Check ODU software version

OPERATION PARAMETER	#00
T3 OUTDOOR EXCHANGE TEMP.	XX °C
T4 OUTDOOR AIR TEMP	XX °C
TF MODULE TEMP.	XX °C
P1 COMP PRESSURE	XX Kpa
ODU SOFTWARE	XX-XX-XXXXXXX
HMI SOFTWARE	XX-XX-XXXXXXX
ADDRESS	9/9

## 12 Climate Related Curves

The climate related curves can be selected in the user interface, **MENU > PRESET TEMPERATURE > WEATHER TEMP. SET.**

In cooling/heating mode, eight curves which are already set in the user interface can be selected. Once the curve is selected, the leaving water set temperature (T1s) is determined by the outdoor temperature(T4).

ECO mode is only suitable for heating mode. It has lower water temperature setting inside the program, which is more energy saving.

The relationship between outdoor ambient temperature (T4) and leaving water set temperature (T1s) is described as in Figure 3-12.2, Figure 3-12.3, Figure 3-12.4 and Figure 3-12.5.

Figure 3-12.1: WEATHER TEMP.SET menu

PRE SET TEMPERATURE		
PRESET TEMP	<b>WEATHER TEMPSET</b>	ECO MODE
<b>ZONE1 C-MODE LOW TEMP</b>		OFF
ZONE1 H-MODE LOW TEMP		OFF
ZONE2 C-MODE LOW TEMP		OFF
ZONE2 H-MODE LOW TEMP		OFF
<input type="checkbox"/> ON/OFF		<input type="checkbox"/>

Figure 3-12.2: Low temperature curves for heating mode<sup>1</sup>

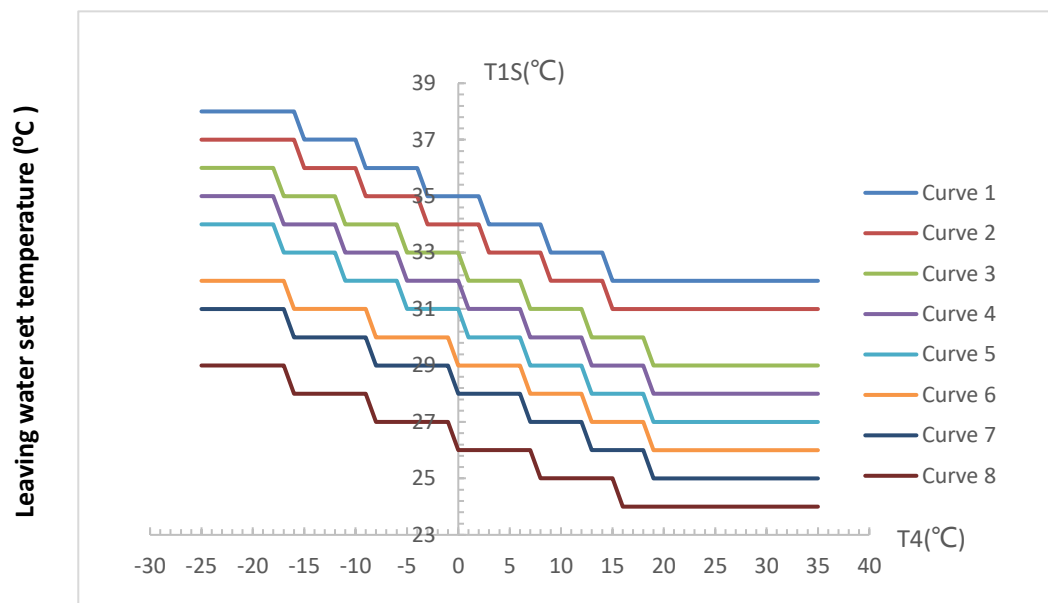

Notes:

1. It only has the curves of the low temperature setting for heating, if the low temperature is set for heating.
2. Curve 4 is default in low temperature heating mode and curve 6 is default in ECO mode.

Figure 3-12.3: High temperature curves for heating mode<sup>1</sup>

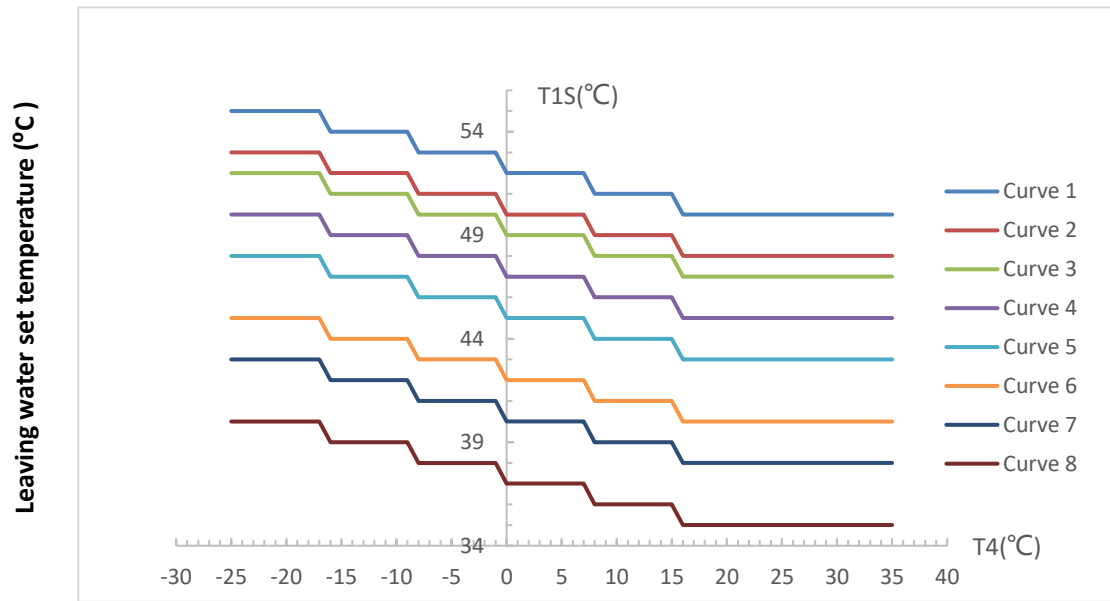

Notes:

1. It only has the curves of the high temperature setting for heating, if the high temperature is set for heating.
2. Curve 4 is default in high temperature heating mode and curve 6 is default in ECO mode.

Figure 3-12.4: Low temperature curves for cooling mode<sup>1</sup>

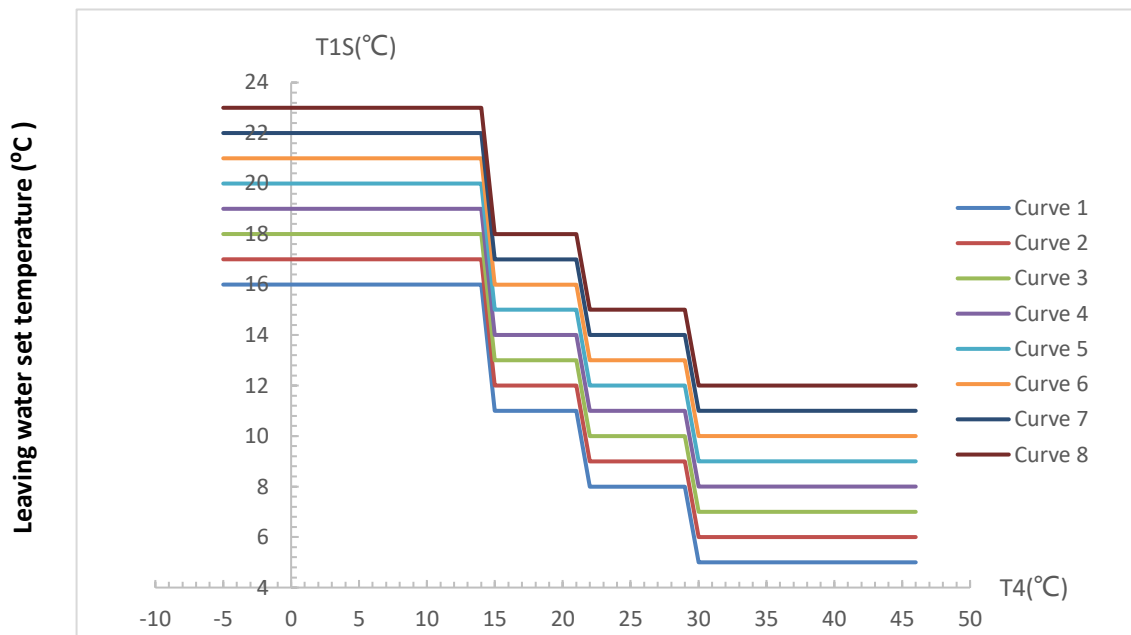

Notes:

1. It only has the curves of the low temperature setting for cooling, if the low temperature is set for cooling.
2. Curve 4 is default in low temperature cooling mode.

Figure 3-12.5: High temperature curves for cooling mode<sup>1</sup>

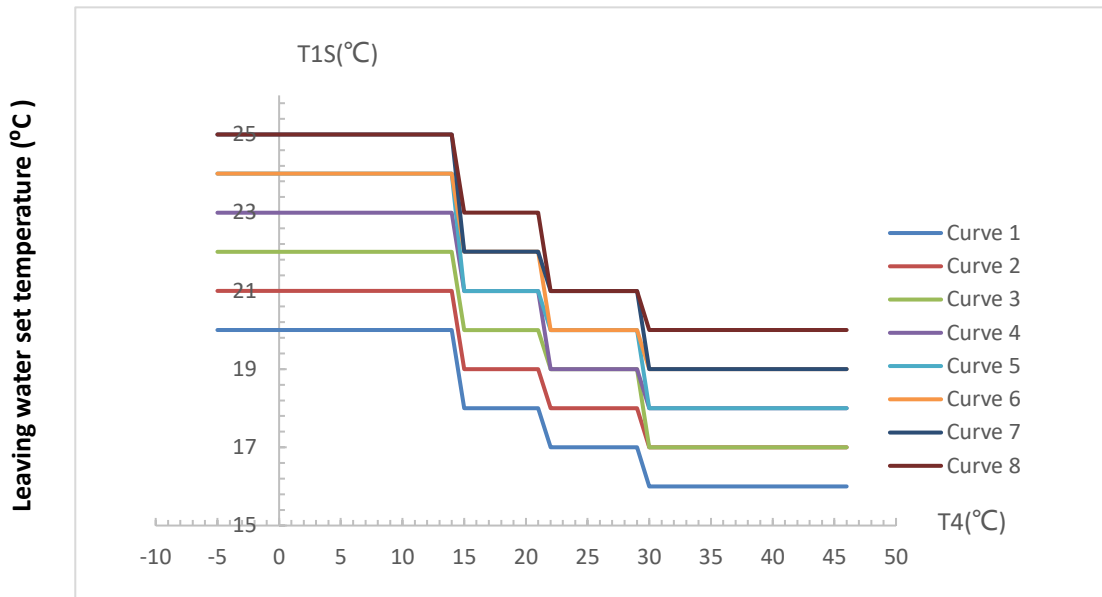

Notes:

1. It only has the curves of the high temperature setting for cooling, if the high temperature is set for cooling.
2. Curve 4 is default in high temperature cooling mode.

There is one customized curve which can set by user according to using habits. Users just need to input the ambient temperature and desire water temperature for two working condition to build the customized curve. The setting of T1SETH1, T1SETH2, T4H1, T4H2 refer to Part 3, 8.6" HEATING MODE SETTING Menu" and T1SETC1, T1SETC2, T4C1, T4C2 refer to Part 3, 8.5" COOLING MODE SETTING Menu".

Figure 3-12.6: Automatic setting curve for heating mode

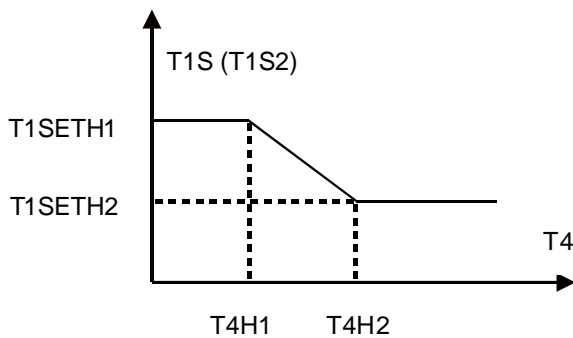
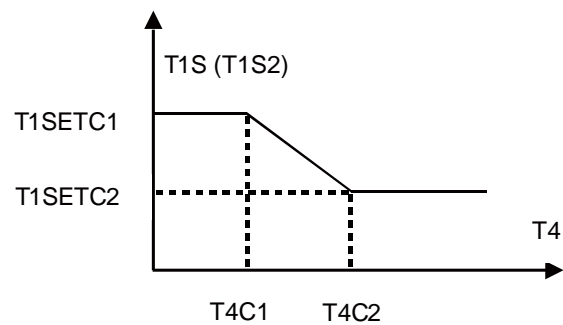

Figure 3-12.7: Automatic setting curve for cooling mode





## 13 Error Code Table

Table 3-13.1: Error code table

Error code	Content
C7	Transducer module temperature too high protection
E0	Water flow failure (E8 appears 3 times)
E1	Phase sequence error (for 3 phase models)
E2	Communication error between the main control board of hydraulic module and user interface
E3	Backup electric heater exchanger water outlet temperature sensor T1 error
E4	Domestic hot water tank temperature sensor T5 error
E5	Air side heat exchanger refrigerant outlet temperature sensor T3 error
E6	Outdoor ambient temperature sensor T4 error
E7	Balance tank sensor Tbt1 error
E8	Water flow failure within 3 times
E9	Suction pipe temperature sensor Th error
EA	Discharge pipe temperature sensor Tp error
Eb	Solar board sensor Tsolar error
Ec	Balance tank sensor Tbt2 error
Ed	Water side heat exchanger water inlet temperature sensor Twin error
EE.	Hydronic box EEPROM error
F1	DC generatrix voltage is too low
H0	Communication error between outdoor unit main control chip and hydronic box main control chip
H1	Communication error between outdoor unit main control chip and inverter driver chip
H2	Water side heat exchanger refrigerant outlet (liquid pipe) temperature sensor T2 error
H3	Water side heat exchanger refrigerant inlet (gas pipe) temperature sensor T2B error
H4	Inverter module protection (L0/L1 appear 3 times in one hour)
H5	Room temperature sensor Ta error
H6	DC fan error
H7	Abnormal main circuit voltage
H8	Pressure sensor error
H9	Zone 2 water outlet temperature sensor Tw2 error
HA	Water side heat exchanger water outlet temperature sensor error
Hb	PP protection appears three times in a row and Twout<7°C
H.F.	Invert module EEPROM error
HH	H6 appears 10 times in 120min
HP	Low pressure protection (pressure < 0.6MPa for 3 times in one hour)
P0	Low pressure protection
P1	High pressure protection
P3	Compressor current protection
P4	Discharge temperature sensor Tp protection
P5	High temperature difference between water side heat exchanger water inlet and water outlet temperatures protection
P6	Inverter module protection
L0	Inverter module protection
L1	DC bus low voltage protection
L2	DC bus high voltage protection

Table continued on next page ...

*Table 3-13.1: Error code table(continued)*

L4	MCE error
L5	Zero speed protection
L7	Phase sequence error
L8	Compressor frequency variation greater than 15Hz within one second protection
L9	Actual compressor frequency differs from target frequency by more than 15Hz protection
Pb	Water side heat exchanger anti-freeze protection
Pd	Air side heat exchanger refrigerant outlet temperature sensor T3 error
PP	Water side heat exchanger inlet temperature is higher than outlet temperature in heating/DHW mode
bH	PED board error

**Midea Building Technologies Division**  
**Midea Group**

**Add.:** Midea Headquarters Building, 6 Midea Avenue, Shunde, Foshan, Guangdong, China

**Postal code:** 528311

[mbt.midea.com](http://mbt.midea.com) / [global.midea.com](http://global.midea.com)

Midea reserves the right to change the specifications of the product, and to withdraw or replace products without prior notification or public announcement. Midea is constantly developing and improving its products.

